



Installation Instructions

1769-L32E, 1769-L35E CompactLogix Controller

Catalog Numbers 1769-L32E, 1769-L35E

Topic	Page
About This Publication	2
Important User Information	3
North American Hazardous Location Approval	4
Environment and Enclosure	5
Before You Begin	6
Prevent Electrostatic Discharge	7
Connect the 1769-BA Battery	7
Install a 1784-CF64 or 1784-CF128 Industrial CompactFlash Card (optional)	9
Assemble the System	9
Mount the System	11
Make RS-232 Connections to the Controller	15
Make Ethernet Connections to the Controller	18
Load the Controller Firmware	25
Select the Controller's Operating Mode	30
Make Ethernet Connections to the Controller	18
Load the Controller Firmware	25
Select the Controller's Operating Mode	30
Controller Status Indicators	31
RS-232 Serial Port Status Indicators (Channel 0 and 1)	33

2 1769-L32E, 1769-L35E CompactLogix Controller

Topic	Page
CompactFlash Card Status Indicator	33
Module Status (MS) indicator	34
Additional Resources	39

About This Publication

Use this document as a guide to install the CompactLogix controller.

Important User Information

Solid state equipment has operational characteristics differing from those of electromechanical equipment. Safety Guidelines for the Application, Installation and Maintenance of Solid State Controls (publication SGI-1.1 available from your local Rockwell Automation sales office or online at <http://literature.rockwellautomation.com>) describes some important differences between solid state equipment and hard-wired electromechanical devices. Because of this difference, and also because of the wide variety of uses for solid state equipment, all persons responsible for applying this equipment must satisfy themselves that each intended application of this equipment is acceptable.





In no event will Rockwell Automation, Inc. be responsible or liable for indirect or consequential damages resulting from the use or application of this equipment.

The examples and diagrams in this manual are included solely for illustrative purposes. Because of the many variables and requirements associated with any particular installation, Rockwell Automation, Inc. cannot assume responsibility or liability for actual use based on the examples and diagrams.

No patent liability is assumed by Rockwell Automation, Inc. with respect to use of information, circuits, equipment, or software described in this manual.



Reproduction of the contents of this manual, in whole or in part, without written permission of Rockwell Automation, Inc., is prohibited.

Throughout this manual, when necessary, we use notes to make you aware of safety considerations.

<p>WARNING</p> 	<p>Identifies information about practices or circumstances that can cause an explosion in a hazardous environment, which may lead to personal injury or death, property damage, or economic loss.</p>
<p>IMPORTANT</p>	<p>Identifies information that is critical for successful application and understanding of the product.</p>
<p>ATTENTION</p> 	<p>Identifies information about practices or circumstances that can lead to personal injury or death, property damage, or economic loss. Attentions help you to identify a hazard, avoid a hazard and recognize the consequences.</p>
<p>SHOCK HAZARD</p> 	<p>Labels may be on or inside the equipment, for example, a drive or motor, to alert people that dangerous voltage may be present.</p>
<p>BURN HAZARD</p> 	<p>Labels may be on or inside the equipment, for example, a drive or motor, to alert people that surfaces may reach dangerous temperatures.</p>

North American Hazardous Location Approval

The following information applies when operating this equipment in hazardous locations.	Informations sur l'utilisation de cet équipement en environnements dangereux.
Products marked "CL I, DIV 2, GP A, B, C, D" are suitable for use in Class I Division 2 Groups A, B, C, D, Hazardous Locations and nonhazardous locations only. Each product is supplied with markings on the rating nameplate indicating the hazardous location temperature code. When combining products within a system, the most adverse temperature code (lowest "T" number) may be used to help determine the overall temperature code of the system. Combinations of equipment in your system are subject to investigation by the local Authority Having Jurisdiction at the time of installation.	Les produits marqués "CL I, DIV 2, GP A, B, C, D" ne conviennent qu'à une utilisation en environnements de Classe I Division 2 Groupes A, B, C, D dangereux et non dangereux. Chaque produit est livré avec des marquages sur sa plaque d'identification qui indiquent le code de température pour les environnements dangereux. Lorsque plusieurs produits sont combinés dans un système, le code de température le plus défavorable (code de température le plus faible) peut être utilisé pour déterminer le code de température global du système. Les combinaisons d'équipements dans le système sont sujettes à inspection par les autorités locales qualifiées au moment de l'installation.

WARNING	EXPLOSION HAZARD	AVERTISSEMENT	RISQUE D'EXPLOSION
	<p>Do not disconnect equipment unless power has been removed or the area is known to be nonhazardous.</p> <p>Do not disconnect connections to this equipment unless power has been removed or the area is known to be nonhazardous. Secure any external connections that mate to this equipment by using screws, sliding latches, threaded connectors, or other means provided with this product.</p> <p>Substitution of components may impair suitability for Class I, Division 2.</p> <p>If this product contains batteries, they must only be changed in an area known to be nonhazardous.</p>		<p>Couper le courant ou s'assurer que l'environnement est classé non dangereux avant de débrancher l'équipement.</p> <p>Couper le courant ou s'assurer que l'environnement est classé non dangereux avant de débrancher les connecteurs. Fixer tous les connecteurs externes reliés à cet équipement à l'aide de vis, loquets coulissants, connecteurs filetés ou autres moyens fournis avec ce produit.</p> <p>La substitution de composants peut rendre cet équipement inadapté à une utilisation en environnement de Classe I, Division 2.</p> <p>S'assurer que l'environnement est classé non dangereux avant de changer les piles.</p>

Environment and Enclosure

ATTENTION

This equipment is intended for use in a Pollution Degree 2 industrial environment, in overvoltage Category II applications (as defined in IEC publication 60664-1), at altitudes up to 2000 meters (6562 feet) without derating.

This equipment is considered Group 1, Class A industrial equipment according to IEC/CISPR Publication 11. Without appropriate precautions, there may be potential difficulties ensuring electromagnetic compatibility in other environments due to conducted as well as radiated disturbance.

This equipment is supplied as open-type equipment. It must be mounted within an enclosure that is suitably designed for those specific environmental conditions that will be present and appropriately designed to prevent personal injury resulting from accessibility to live parts. The enclosure must have suitable flame-retardant properties to prevent or minimize the spread of flame, complying with a flame spread rating of 5VA, V2, V1, V0 (or equivalent) if non-metallic. The interior of the enclosure must be accessible only by the use of a tool. Subsequent sections of this publication may contain additional information regarding specific enclosure type ratings that are required to comply with certain product safety certifications.

In addition to this publication, see:

- Industrial Automation Wiring and Grounding Guidelines, publication 1770-4.1, for additional installation requirements.
 - NEMA Standards publication 250 and IEC publication 60529, as applicable, for explanations of the degrees of protection provided by different types of enclosure.
-



Before You Begin

Consider the following when planning your CompactLogix system:

- The CompactLogix controller is always the leftmost module in the system.
- The controller must be located within four modules of the system power supply. Some I/O modules may be located up to eight modules away from the power supply. See the documentation for your 1769 I/O modules for details.
- The 1769-L32E and 1769-L35E controllers support as many as 16 I/O modules in a maximum of 3 I/O banks with 2 expansion cables.
- Each I/O bank requires its own power supply.
- Only one controller can be used in a CompactLogix system.
- A 1769-ECR right end cap or 1769-ECL left end cap is required to terminate the end of the communication bus.

Parts List

These components ship with the controller.

Component	Description
	1769-BA battery Important: The 1769-BA battery is the only battery you can use with the 1769-L32E and 1769-L35E controllers.
	1747-KY controller key

You may also use these components with the controller.

If you want to	Then use this component
Connect a device to the RS_232 port	1756-CP3 or 1747-CP3 serial cable
Connect a device to the EtherNet/IP port	standard Ethernet cable with RJ-45 connector
Add nonvolatile memory	1784-CF64 or 1784-CF128 Industrial CompactFlash card

Prevent Electrostatic Discharge

Follow these guidelines to prevent electrostatic damage.

ATTENTION

This equipment is sensitive to electrostatic discharge, which can cause internal damage and affect normal operation. Follow these guidelines when you handle this equipment:

- Touch a grounded object to discharge potential static.
 - Wear an approved grounding wriststrap.
 - Do not touch connectors or pins on component boards.
 - Do not touch circuit components inside the equipment.
 - Use a static-safe workstation, if available.
 - Store the equipment in appropriate static-safe packaging when not in use.
-

Connect the 1769-BA Battery

The controller is shipped with the 1769-BA battery packed separately. To connect the battery, follow this procedure.

ATTENTION

The 1769-BA battery is the only battery you can use with the 1769-L32E and 1769-L35E controllers. The 1747-BA battery is not compatible with the 1769-L32E and 1769-L35E controllers and may cause problems.

WARNING

When you connect or disconnect the battery, an electrical arc can occur. This could cause an explosion in hazardous location installations. Be sure that power is removed or the area is nonhazardous before proceeding.

For safety information on the handling of lithium batteries, including handling and disposal of leaking batteries, see Guidelines for Handling Lithium Batteries Technical Data, publication AG-5.4NOV04.

1. Remove the battery door by sliding it forward.

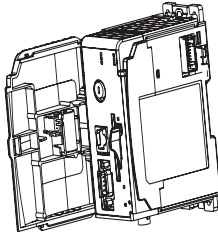

IMPORTANT

Do not remove the plastic insulation covering the battery. The insulation is necessary to protect the battery contacts.

2. Insert the battery connector into the connector port.
The connector is keyed to be installed with the correct polarity.
3. Insert the battery into the battery port in the battery door.

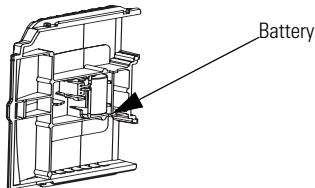

4. Slide the battery door back until it clicks into position.

Install a 1784-CF64 or 1784-CF128 Industrial CompactFlash Card (optional)

ATTENTION

Do not remove the CompactFlash card while the controller is reading from or writing to the card, as indicated by a flashing green CF status indicator. This could corrupt the data on the card or in the controller, as well as corrupt the latest firmware in the controller.

The optional industrial CompactFlash card provides nonvolatile memory for a CompactLogix controller. The card is not required for controller operation.

Follow this procedure to install the card.

WARNING

When you insert or remove the CompactFlash Card while power is on, an electrical arc can occur. This could cause an explosion in hazardous location installations.

Be sure that power is removed or the area is nonhazardous before proceeding.

1. Push the locking tab to the right and insert the industrial CompactFlash card into the socket on the front of the controller.

The label of the CompactFlash card faces toward the left. Match the orientation arrow on the card with the arrow on the front of the controller.

2. To remove the CompactFlash card, push the locking tab away from the CompactFlash card and pull the CompactFlash card from the socket.

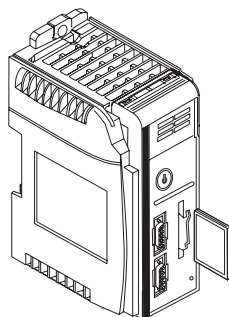

Assemble the System

The controller can be attached to an adjacent I/O module or power supply before or after mounting. For mounting instructions, see

Grounding Considerations on page 12 or DIN Rail Mounting on page 14.

WARNING



The CompactLogix controller is not designed for removal and insertion under power.

If you insert or remove the module while backplane power is on, an electrical arc can occur. This could cause an explosion in hazardous location installations.

Be sure that power is removed or the area is nonhazardous before proceeding.

This procedure shows you how to install the controller in a CompactLogix system.

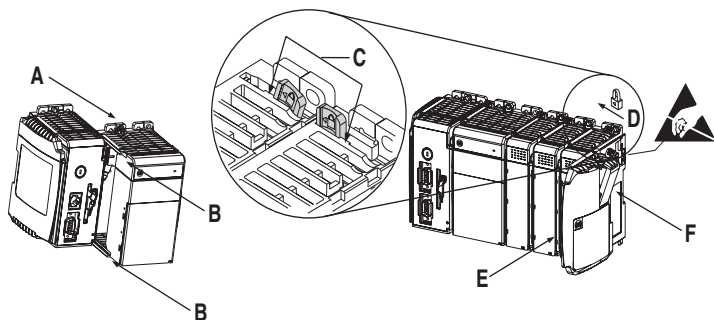

1. Disconnect line power.
2. Check that the lever of the adjacent module (A) is in the unlocked (fully right) position.
3. Use the upper and lower tongue-and-groove slots (B) to secure the modules together.
4. Move the module back along the tongue-and-groove slots until the bus connectors line up with each other.
5. Use your fingers or a small screwdriver to push the module's bus lever back slightly to clear the positioning tab (C).

- Move the module's bus lever fully to the left (D) until it clicks, being sure it is locked firmly in place.

ATTENTION

When attaching the controller, power supply, and I/O modules, make sure the bus connectors are securely locked together to be sure of proper electrical connection.

- Attach an end cap terminator (E) to the last module in the system by using the tongue-and-groove slots as before.
- Lock the end cap bus terminator (F).

Mount the System

ATTENTION

During panel or DIN rail mounting of all devices, be sure that all debris (such as metal chips or wire strands) is kept from falling into the controller. Debris that falls into the controller could cause damage while the controller is energized.

Minimum Spacing

Maintain spacing from enclosure walls, wireways, and adjacent equipment. Allow 50 mm (2 in.) of space on all sides, as shown. This provides ventilation and electrical isolation.

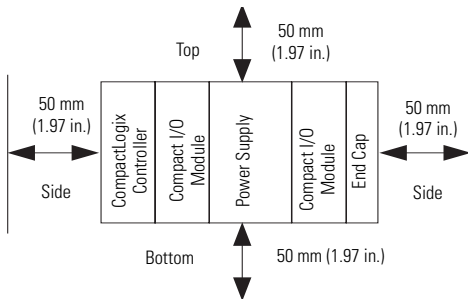

System Dimensions

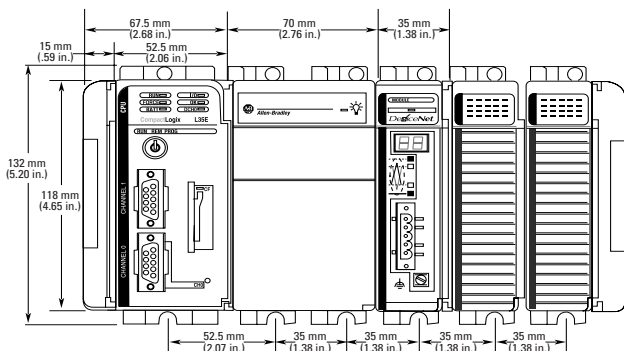

TIP

Compact I/O expansion cables have the same dimensions as the end caps. Expansion cables can be used on either the right or left end. A 1769-ECR right end cap or 1769-ECL left end cap terminates the end of the communication bus.

Grounding Considerations

ATTENTION



This product is grounded through the DIN rail to chassis ground. Use zinc plated yellow-chromate steel DIN rail to assure proper grounding. The use of other DIN rail materials (such as aluminum or plastic) that can corrode, oxidize, or are poor conductors, can result in improper or intermittent grounding. Secure DIN rail to mounting surface approximately every 200 mm (7.8 in.) and use end-anchors appropriately.

This product is intended to be mounted to a well-grounded mounting surface such as a metal panel. Additional grounding connections from the controller's mounting tabs or DIN rail (if used) are not required unless the mounting surface cannot be grounded.

Refer to publication 1770-4.1, Industrial Automation Wiring and Grounding Guidelines, for additional information.

Panel Mounting

Mount the controller to a panel by using two screws per module. Use M4 or #8 panhead screws. Mounting screws are required on every module.

This procedure lets you use the assembled modules as a template for drilling holes in the panel.

IMPORTANT

Due to module mounting hole tolerance, it is important to follow these procedures.

1. On a clean work surface, assemble no more than three modules.
2. Using the assembled modules as a template, carefully mark the center of all module-mounting holes on the panel.
3. Return the assembled modules to the clean work surface, including any previously mounted modules.
4. Drill and tap the mounting holes for the recommended M4 or #8 screw.
5. Place the modules back on the panel and check for proper hole alignment.

TIP

The grounding plate, located where the you install the mounting screws, enables the module to be grounded when it is panel-mounted.

6. Attach the modules to the panel by using the mounting screws.

TIP

If you are mounting more modules, mount only the last one of this group and put the others aside. This reduces remounting time when you are drilling and tapping the next group of modules.

7. Repeat steps 1...6 for any remaining modules.

DIN Rail Mounting

The controller can be mounted on the following DIN rails:

- EN 50 022 - 35 x 7.5 mm (1.38 x 0.30 in.)
- EN 50 022 - 35 x 15 mm (1.38 x 0.59 in.)

ATTENTION



This product is grounded through the DIN rail to chassis ground. Use zinc plated yellow-chromate steel DIN rail to assure proper grounding. The use of other DIN rail materials (for example, aluminum or plastic) that can corrode, oxidize, or are poor conductors, can result in improper or intermittent grounding. Secure DIN rail to mounting surface approximately every 200 mm (7.8 in.) and use end-anchors appropriately.

1. Before mounting the controller on a DIN rail, close the DIN rail latches.
2. Press the DIN rail mounting area of the controller against the DIN rail.

The latches will momentarily open and lock into place.

Make RS-232 Connections to the Controller

Connect the 9-pin female end of the serial cable to the serial port of the controller.

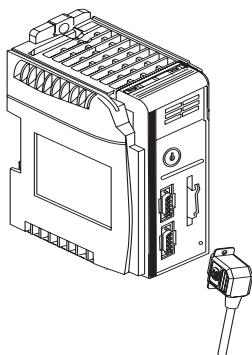

WARNING



If you connect or disconnect the serial cable with power applied to this module or the serial device on the other end of the cable, an electrical arc can occur. This could cause an explosion in hazardous location installations.

Be sure that power is removed or the area is nonhazardous before proceeding.

RS-232 Cable

9-pin, Male D-shell Straight Cable End

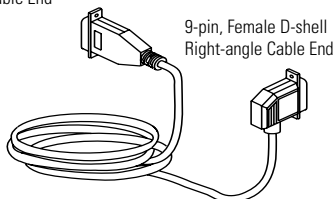

1747-CP3 or 1756-CP3

This cable must be shielded and tied to the connector housing.

9-pin, Female D-shell Right-angle Cable End

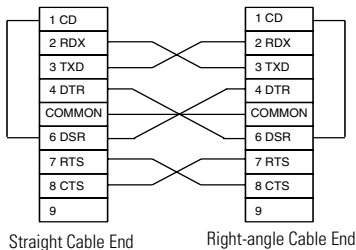

Straight Cable End

Right-angle Cable End

Default Serial Configuration

Channel 0 and Channel 1 (both serial ports) have the following default communication configuration.

Parameter	Default
Protocol	DF1 full-duplex
Communication Rate	19.2 Kbps
Parity	None
Station Address	0
Control Lines	No Handshaking
Error Detection	BCC
Embedded Responses	Auto Detect
Duplicate Packet (Message) Detect	Enabled
ACK Timeout	50 (x 20 ms)
NAK Receive Limit	3 Retries
ENQ Transmit Limit	3 Retries
Data Bits	8
Stop Bits	1

TIP

Only Channel 0 has a default communication push button (see page 17).

Using the Channel 0 Default Communication Push Button

The Channel 0 default communication push button is located on the front of the controller in the lower right corner as shown in the illustration.

Use the Channel 0 default communication push button to change from the user-defined communication configuration to the default communication mode. The Channel 0 default communication (DCH0) status indicator turns on (green, steady) to indicate that the default communication configuration is active.

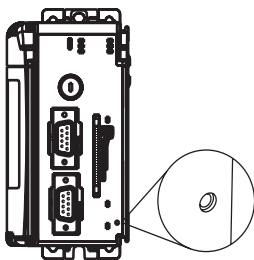

TIP

The default communication push button is recessed.

Before pressing the default communication push button, be sure to note the present communication configuration for Channel 0. Pushing the default communication push button resets all configured parameters back to their default settings.

To return the channel to its user-configured parameters, you must enter them manually while online with the controller or download them as part of an RSLogix 5000 software project file. To do this online with RSLogix 5000 software, access the Controller Properties dialog and enter parameters on the Serial Port, System Protocol, and User Protocol tabs.

Make Ethernet Connections to the Controller

The 1769-L32E and 1769-L35E controllers ship with the BOOTP utility enabled. You must assign an IP address to the Ethernet port in order for the controller to communicate over an EtherNet/IP network.

WARNING



If you connect or disconnect the communications cable with power applied to this module or any device on the network, an electrical arc can occur. This could cause an explosion in hazardous location installations.

Be sure that power is removed or the area is nonhazardous before proceeding.

Connect the RJ-45 connector of the Ethernet cable to the Ethernet port (top port, CH1) on the controller.

ATTENTION



Do not plug a DH-485 network cable or a NAP port cable into the Ethernet port. Undesirable behavior and/or damage to the port may result.

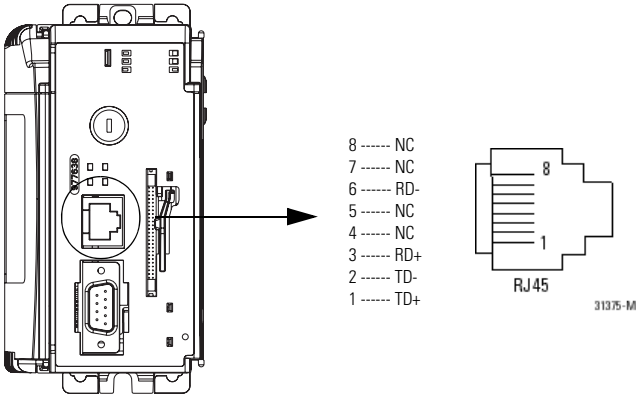

Assigning an IP address

You can set the IP address using any of these utilities:

- Rockwell BOOTP Utility (available with RSLinx and RSLogix 5000 software)
- RSLinx software
- RSLogix 5000 software

Use BOOTP to set the IP address

The BOOTP utility is a standalone program that is located in one of the following directories:

- RSLinx Tools directory in the Rockwell Software program folder on the Start menu (the utility is automatically installed when you install RSLinx software)
- Utils directory on the RSLogix 5000 software installation CD

Follow this procedure to use the BOOTP utility.

1. Start the BOOTP software.
2. Select Tools>Network Settings.
3. Enter the Ethernet mask and gateway.
4. Click Ok.

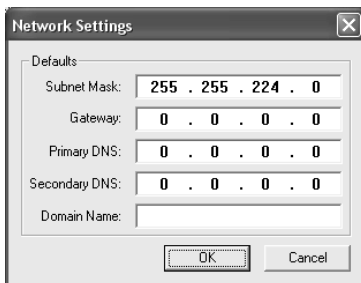

In the BOOTP Request History dialog you see the hardware addresses of devices issuing BOOTP requests.

5. Double-click on the hardware address of the device you want to configure.

TIP

The hardware address is on the sticker located on the left-side circuit board of the controller next to the battery. See Connect the 1769-BA Battery on page 7 for instructions on accessing this area.

The hardware address will be in this format: 00-0b-db-14-55-35.

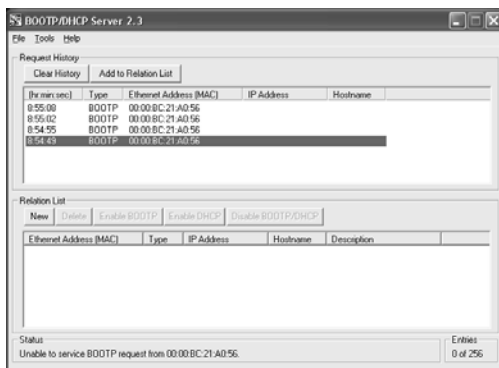

The New Entry dialog displays the device's Ethernet Address (MAC).

6. Enter the IP address.

7. Click Ok.

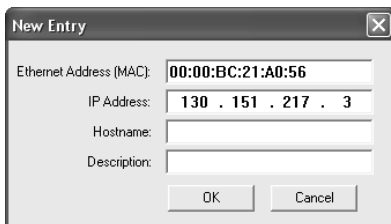

The image shows a 'New Entry' dialog box with the following fields and values:

Field	Value
Ethernet Address (MAC)	00:00:BC:21:A0:56
IP Address	130 . 151 . 217 . 3
Hostname	
Description	

8. To permanently assign this configuration to the device, highlight the device and click Disable BOOTP/DHCP.

When power is recycled, the device uses the configuration you assigned and does not issue a BootP request.

Use RSLinx software to set the IP address

You can use RSLinx software, version 2.41 or later, to set the IP address.

1. Make sure the controller that uses the IP address is installed and running.
2. Connect to the controller via the serial connection (see page 15).
3. Start RSLinx software.
The RSWho dialog opens.
4. Navigate to the Ethernet network.

5. Right-click the Ethernet port (not the controller) and select Module Configuration

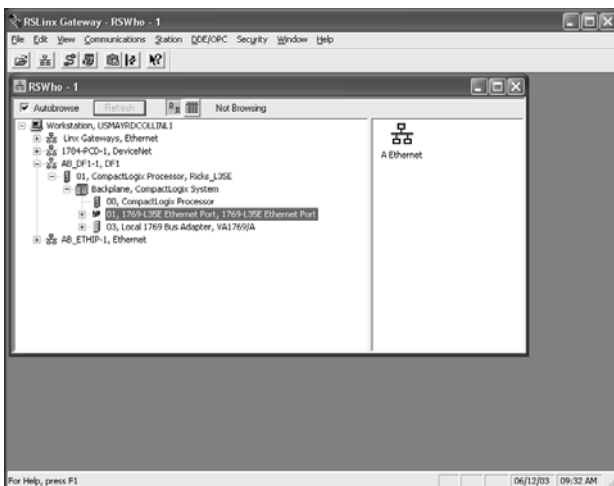

6. Select the Port Configuration tab.

- Click the appropriate radio button to choose the Status Network Configuration type.



- Enter the IP address, network (subnet) mask, and gateway address (if needed).

Use RSLogix 5000 software to set the IP address

You can use RSLogix software to set the IP address.

- Make sure the controller that uses the IP address is installed and running.
- Connect to the controller via the serial connection (see page 15).

3. Start RSLogix 5000 software. In the Controller Organizer, select properties for the Ethernet port.

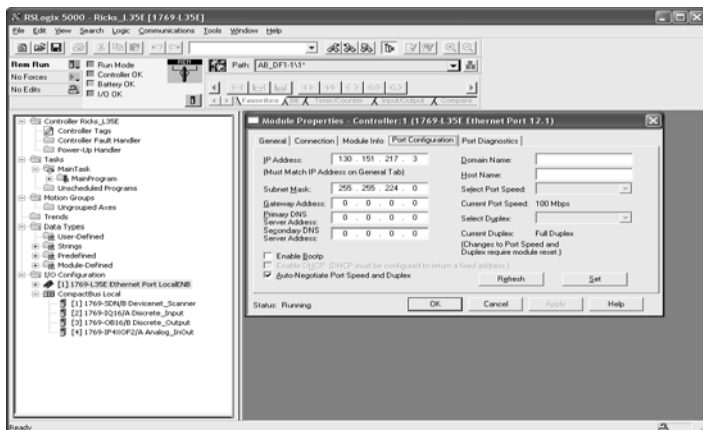

4. Choose the Port Configuration tab.
5. Specify the IP address.
6. Click Apply.
7. Click Ok.

This sets the IP address in the hardware. This IP address should be the same IP address you assigned under the General tab.

Install the Appropriate EDS Files

If you have RSLinx software, version 2.42 or later, the most current EDS files were installed with the software. If you are using an earlier version of RSLinx software, you might need to install EDS files.

You need EDS files for these devices:

- 1769-L32E and 1769-L35E controllers
- 1769 CompactBus
- 1769 local adapter

All of these EDS files, except for the 1769 CompactBus file, are updated for each firmware revision. There is also a version 1 of the controller EDS file that you need for new controllers. Each controller ships with revision 1 firmware. In order to update the firmware, you must have the revision 1 EDS file (0001000E00410100.edc) installed for the controller.

The EDS files are available on the RSLogix 5000 Enterprise Series software CD. The files are also available at <http://www.ab.com/networks/eds>.

Load the Controller Firmware

You must download the current firmware before you can use the controller.

To load firmware, you can use any of the following:

- ControlFlash utility that ships with RSLogix 5000 programming software.
- AutoFlash that launches through RSLogix 5000 software when you try to open or create a project and the controller does not have the current firmware.
- A CompactFlash card (catalog number 1784-CF64 or 1784-CF128) with valid memory already loaded.

If you use the ControlFlash or AutoFlash utilities, you need a serial connection to the controller.

The firmware is available with RSLogix 5000 software or you can download it from the support website. Go to <http://support.rockwellautomation.com>.

Follow these steps to download firmware from the support website.

- 1.** In the left column (frame), click Technical Support.
- 2.** Click Firmware Updates.
- 3.** Select the firmware revision.
- 4.** Enter the serial number of your RSLogix 5000 programming software.

Use the ControlFlash Utility to Load Firmware

You can use the ControlFlash utility to load firmware through a serial connection.

- 1.** Make sure the appropriate network connection is made before starting.
- 2.** Start the ControlFlash utility.
- 3.** When the Welcome dialog appears, click Next.
- 4.** Choose the catalog number of the controller and click Next.
- 5.** Expand the network until you see the controller.
- 6.** If the required network is not shown, first configure a driver for the network in RSLinx software.
- 7.** Choose the controller and click Ok.
- 8.** Choose the revision level to which you want to update the controller and click Next.
- 9.** To start the update of the controller, click Finish and then click Yes.
- 10.** After the controller is updated, the status dialog displays Update complete.
- 11.** Click Ok.
- 12.** To close the ControlFlash utility, click Cancel and then click Yes.

Use AutoFlash to Load Firmware

You can use AutoFlash to load firmware through a serial connection.

1. Make sure the appropriate network connection is made before starting.
2. Use RSLogix 5000 programming software to create a controller project.

This automatically launches AutoFlash.

3. Choose the catalog number of the controller and click Next.
4. Expand the network until you see the controller.
If the required network is not shown, first configure a driver for the network in RSLinx software.
5. Choose the controller and click Ok.
6. Choose the revision level to which you want to update the controller and click Next.
7. To start the update of the controller, click Finish and then click Yes.

After the controller is updated, the status dialog displays Update complete.

8. Click Ok.
9. To close the AutoFlash utility, click Cancel and then click Yes.

Use a CompactFlash Card to Load Firmware

If you have an existing controller that is already configured and has firmware loaded, you can store the current controller user program and firmware on the CompactFlash card and use that card to update other controllers.

1. Use RSLogix 5000 software to store the controller user program and firmware of a currently configured controller to the CompactFlash card.
2. Access the Nonvolatile Memory tab of the Controller Properties dialog.

Be sure to select Load Image On Powerup when you save to the card.

3. Remove the card and insert it into a controller that will use the same firmware and controller user program.

When you apply power to the second controller, the image stored on the CompactFlash card is loaded into the controller.

Select the Controller's Operating Mode

Use the keyswitch on the front panel of the controller to determine the controller's operating mode.

Keyswitch Position	Description	
Run	<ul style="list-style-type: none"> •Upload projects. •Run the program and enable outputs. •You cannot create or delete tasks, programs, or routines. You cannot create or delete tags or edit online while the keyswitch is in the Run position. •You cannot change the mode by using the programming software while the keyswitch is in the Run position. 	
Prog	<ul style="list-style-type: none"> •Disable outputs. •Upload/download projects. •Create, modify, and delete tasks, programs, or routines. •The controller does not execute (scan) tasks while the keyswitch is in the Prog position. •You cannot change the mode through the programming software while the keyswitch is in the Prog position. 	
Rem	<ul style="list-style-type: none"> •Upload/download projects. •Change between Remote Program, Remote Test, and Remote Run modes through the programming software. 	
	Remote Run	<ul style="list-style-type: none"> •The controller executes (scans) tasks. •Enable outputs. •Edit online.
	Remote Program	<ul style="list-style-type: none"> •Disable outputs. •Create, modify, and delete tasks, programs or routines. •Download projects. •Edit online. •The controller does not execute (scan) tasks.
	Remote Test	<ul style="list-style-type: none"> •Execute tasks with outputs disabled. •Edit online.

Controller Status Indicators

Indicator	Status	Description
RUN	Off	The controller is in Program or Test mode.
	Solid green	The controller is in Run mode.
FORCE	Off	<ul style="list-style-type: none"> •No tags contain I/O force values. •I/O forces are inactive (disabled).
	Solid amber	<ul style="list-style-type: none"> •I/O forces are active (enabled). •I/O force values may or may not exist.
	Flashing amber	One or more input or output addresses have been forced to an On or Off state, but the forces have not been enabled.
BAT	Off	The battery supports memory.
	Solid red	Either the battery is: <ul style="list-style-type: none"> •not installed. •95% discharged and should be replaced.
I/O	Off	Either: <ul style="list-style-type: none"> •There are no devices in the I/O configuration of the controller. •The controller does not contain a project (controller memory is empty).
	Solid green	The controller is communicating with all the devices in its I/O configuration.
	Flashing green	One or more devices in the I/O configuration of the controller are not responding.
	Flashing red	<ul style="list-style-type: none"> •The controller is not communicating to any devices. •The controller is faulted.

32 1769-L32E, 1769-L35E CompactLogix Controller

Indicator	Status	Description
OK	Off	No power is applied.
	Flashing red	If the controller is new, the controller requires a firmware update. If the controller is not new, a major fault occurred. To clear the fault, do one of the following: <ul style="list-style-type: none">•Turn the keyswitch from Prog to Run to Prog.•Go online with RSLogix 5000 software.
	Solid red	The controller detected a nonrecoverable fault, so it cleared the project from memory. Follow these steps to recover. <ol style="list-style-type: none">1. Cycle power to the chassis.2. Download the project.3. Change to Run mode. If the OK status indicator remains solid red, contact your Rockwell Automation representative or local distributor.
	Solid green	Controller is OK.
	Flashing green	The controller is storing or loading a project to or from nonvolatile memory.

RS-232 Serial Port Status Indicators (Channel 0 and 1)

Indicator	Status	Description
DCH0	Off	Channel 0 is configured differently than the default serial configuration.
	Solid green	Channel 0 has the default serial configuration.
CH0	Off	No RS-232 activity.
	Flashing green	RS-232 activity.
CH1	Off	No RS-232 activity.
	Flashing green	RS-232 activity.

CompactFlash Card Status Indicator

ATTENTION

Do not remove the CompactFlash card while the controller is reading from or writing to the card, as indicated by a flashing green CF status indicator. This could corrupt the data on the card or in the controller, as well as corrupt the latest firmware in the controller.

Indicator	Status	Description
CF	Off	No activity.
	Flashing green	The controller is reading from or writing to the CompactFlash card.
	Flashing red	CompactFlash card does not have a valid file system.

Module Status (MS) indicator

Condition	Status	Indicates	Recommended Action
Off	No power	The controller does not have power.	Check the controller power supply.
Flashing green	Standby	The port does not have an IP address and is operating in BOOTP mode.	Verify that the BOOTP server is running.
Solid green	Ok	The port is operating correctly.	Normal operation. No action required.
Solid red	Held in reset	The controller is holding the port in reset or the controller is faulted.	Clear the controller fault. Replace the controller.
	Self-test	The port is performing its power-up self-test.	Normal operation during power-up. No action required.
	Major fault	An unrecoverable fault has occurred.	Cycle power to the controller. Replace the controller.
Flashing red	Updating firmware	The port firmware is being updated.	Normal operation during firmware update. No action required.

Network Status (NS) indicator

Condition	Status	Indicates	Recommended Action
Off	Not initialized	The port does not have an IP address and is operating in BOOTP mode.	Verify that the BOOTP server is running.
Flashing green	No CIP connections established	The port has an IP address, but no CIP connections are established.	Normal operation if no connections are configured. No action required. If connections are configured, check connection originator for connection error code.
Solid green	CIP connections established	The port has an IP address and CIP connections (Class 1 or Class 3) are established.	Normal operation. No action required.
Solid red	Duplicate IP address	The port has detected that the assigned IP address is already in use.	Verify that all IP addresses are unique.
Flashing Red/green	Self-test	The port is performing its power-up self-test.	Normal operation during powerup.

Link Status (LNK) indicator

Condition	Status	Indicates	Recommended Action
Off	No link	The port is not connected to a powered Ethernet device. The port cannot communicate on Ethernet.	<ul style="list-style-type: none"> •Verify that all Ethernet cables are connected. •Verify that Ethernet switch is powered.
Flashing green	Self-test	The port is performing its power-up self-test.	Normal operation during powerup.
	Data transmission and reception	The port is communicating on Ethernet.	Normal operation. No action required.
Solid green	Link Ok	The port is connected to a powered Ethernet device. The port can communicate on Ethernet.	Normal operation. No action required.

Specifications

CompactLogix Controller - 1769-L32E, 1769-L35E

Attribute	Value		
Communication ports	<table border="0"> <tr> <td>CH0 - RS-232 RS-232 DF1, DH-485, ASCII fully isolated 38.4 Kbps max</td> <td>CH1 - RS-232 RS-232 DF1, DH-485 non-isolated 38.4 Kbps max</td> </tr> </table>	CH0 - RS-232 RS-232 DF1, DH-485, ASCII fully isolated 38.4 Kbps max	CH1 - RS-232 RS-232 DF1, DH-485 non-isolated 38.4 Kbps max
CH0 - RS-232 RS-232 DF1, DH-485, ASCII fully isolated 38.4 Kbps max	CH1 - RS-232 RS-232 DF1, DH-485 non-isolated 38.4 Kbps max		
User memory	512 KB		
Nonvolatile memory	1784-CF64 or 1784-CF128 CompactFlash card		
Number of I/O modules, max	16 I/O modules		
Number of I/O banks, max	3 banks		
Backplane current	330 mA at 5V dc 40 mA at 24V dc		
Power dissipation	2.61 W		
Power supply distance rating	4 (The controller must be within four slot positions of the power supply.)		
North American temp code	T4A		
Battery	1769-BA		
Weight, approx.	0.30 kg (0.66 lb)		
Programming cable	1747-CP3 or 1756-CP3		
Panel mounting screw torque (using M4 or #8 screws)	10...16 in.-lb. (1.1...1.8 Nm)		
Enclosure type rating	none (open style)		
Wiring category	2 on communication ports ⁽¹⁾		
Isolation voltage	30V (continuous), Basic Insulation Type Type tested at 710V dc for 60 s, RS232 to system, ENET to system, RS232 to ENET		

⁽¹⁾ Use this Conductor Category information for planning conductor routing. See Industrial Automation Wiring and Grounding Guidelines, publication 1770-4.1.

Environmental Specifications

Attribute	Value
Operational temperature IEC 60068-2-1 (Test Ad, Operating Cold) IEC 60068-2-2 (Test Bd, Operating Dry Heat) IEC 60068-2-14 (Test Nb, Operating Thermal Shock)	0...60 °C (32...+140 °F)
Storage temperature IEC 60068-2-1 (Test Ab, Unpackaged Nonoperating Cold) IEC 60068-2-2 (Test Bb, Unpackaged Nonoperating Dry Heat) IEC 60068-2-14 (Test Na, Unpackaged Thermal Shock)	-40... +85 °C (-40...+185 °F)
Relative humidity IEC 60068-2-30 (Test Db, Unpackaged)	5...95% non-condensing
Vibration IEC 60068-2-6 (Test Fc, Operating)	Operating: 5 g @ 10...500 Hz
Shock IEC 60068-2-27 (Test Ea, Unpackaged Shock) DIN rail mount Panel mount	Operating: 20 g; Nonoperating: 30 g Operating: 30 g; Nonoperating: 40 g
Emissions (CISPR 11)	Group 1, Class A
ESD immunity (IEC61000-4-2)	6 kV contact discharges, 8 kV air discharges
Radiated RF immunity IEC61000-4-3	10V/m with 1 kHz sine-wave 80%AM from 80...2000 MHz 10V/m with 200 Hz 50% Pulse 100%AM at 900 MHz 10V/m with 200 Hz 50% Pulse 100%AM at 1890 MHz 3V/m with 1 kHz sine-wave 80%AM from 2000...2700 MHz
EFT/B immunity (IEC 61000-4-4)	±2 kV at 5 kHz on communication ports
Surge transient immunity (IEC61000-4-5)	±2 kV line-earth(CM) on communication ports
Conducted RF immunity (IEC61000-4-6)	10V rms with 1kHz sine-wave 80% AM from 150 kHz...80 MHz

Certifications

Certifications ⁽¹⁾ (when product is marked)	Value
c-UL-us	UL Listed Industrial Control Equipment, certified for US and Canada. See UL File E65584. UL Listed for Class I, Division 2 Group A,B,C,D Hazardous Locations, certified for U.S. and Canada. See UL File E194810.
CE	European Union 89/336/EEC EMC Directive, compliant with: <ul style="list-style-type: none"> • EN 50082-2; Industrial Immunity • EN 61326; Meas./Control/Lab., Industrial Requirements • EN 61000-6-2; Industrial Immunity • EN 61000-6-4; Industrial Emissions • EN 61131-2; Programmable Controllers (Clause 8, Zone A & B)
C-Tick	Australian Radio Communications Act, compliant with: <ul style="list-style-type: none"> • AS/NZS CISPR 11; Industrial Emissions
EtherNet/IP	ODVA conformance tested to EtherNet/IP specifications.

⁽¹⁾ See the Product Certification link at <http://www.ab.com> for Declarations of Conformity, Certificates, and other certification details.

Additional Resources

These documents contain additional information concerning related Rockwell Automation publications.

Resource	Description
Logix5000 Controllers Common Procedures, publication 1756-PM001	Developing projects for Logix5000 controllers
Logix5000 Controllers General Instructions Reference Manual, publication 1756-RM003	Programming the controller for sequential applications
Logix5000 Controllers Process Control and Drives Instructions Reference Manual, publication 1756-RM006	Programming the controller for process or drives applications
CompactLogix System User Manual, publication 1769-UM0011	Planning, mounting, wiring, and troubleshooting your CompactLogix system
Industrial Automation Wiring and Grounding Guidelines, publication 1770-4.1	Grounding and wiring Allen-Bradley programmable controllers
National Electrical Code - Published by the National Fire Protection Association of Boston, MA.	Wire sizes and types for grounding electrical equipment

You can view or download publications at <http://www.literature.rockwellautomation.com>. To order paper copies of technical documentation, contact your local Rockwell Automation distributor or sales representative.

Rockwell Automation Support

Rockwell Automation provides technical information on the Web to assist you in using its products. At <http://support.rockwellautomation.com>, you can find technical manuals, a knowledge base of FAQs, technical and application notes, sample code and links to software service packs, and a MySupport feature that you can customize to make the best use of these tools.

For an additional level of technical phone support for installation, configuration, and troubleshooting, we offer TechConnect Support programs. For more information, contact your local distributor or Rockwell Automation representative, or visit <http://support.rockwellautomation.com>.

Installation Assistance

If you experience a problem with a hardware module within the first 24 hours of installation, please review the information that's contained in this manual. You can also contact a special Customer Support number for initial help in getting your module up and running.

United States	1.440.646.3434 Monday – Friday, 8am – 5pm EST
Outside United States	Please contact your local Rockwell Automation representative for any technical support issues.

New Product Satisfaction Return

Rockwell tests all of its products to ensure that they are fully operational when shipped from the manufacturing facility. However, if your product is not functioning, it may need to be returned.

United States	Contact your distributor. You must provide a Customer Support case number (see phone number above to obtain one) to your distributor in order to complete the return process.
Outside United States	Please contact your local Rockwell Automation representative for return procedure.

Allen-Bradley, CompactLogix, ControlFlash, Rockwell Automation, RSLinx, RSLogix 5000, and TechConnect are trademarks of Rockwell Automation, Inc.

Trademarks not belonging to Rockwell Automation are property of their respective companies.

www.rockwellautomation.com

Power, Control and Information Solutions Headquarters

Americas: Rockwell Automation, 1201 South Second Street, Milwaukee, WI 53204-2496 USA, Tel: (1) 414.382.2000, Fax: (1) 414.382.4444
Europe/Middle East/Africa: Rockwell Automation, Vorstlaan/Boulevard du Souverain 36, 1170 Brussels, Belgium, Tel: (32) 2 663 0600, Fax: (32) 2 663 0640
Asia Pacific: Rockwell Automation, Level 14, Core F, Cyberport 3, 100 Cyberport Road, Hong Kong, Tel: (852) 2887 4788, Fax: (852) 2508 1846

Publication 1769-IN020-C-EN-P - July 2007

PN 953157-30

Supersedes Publication 1769-IN020B-EN-P - March 2004

Copyright © 2007 Rockwell Automation, Inc. All rights reserved. Printed in the U.S.A.