



SIRIUS SOFT STARTER, S12, 230 A,
132 KW/400 V, 40 DEG., 200-460 V AC,
230 V AC, CAGE CLAMP TERMINALS

| General details: | | |
|---|--|---|
| product brand name | | SIRIUS |
| Product equipment | | |
| <ul style="list-style-type: none"> integrated bridging contact system | | Yes |
| <ul style="list-style-type: none"> thyristors | | Yes |
| Product function | | |
| <ul style="list-style-type: none"> intrinsic device protection | | Yes |
| <ul style="list-style-type: none"> motor overload protection | | Yes |
| <ul style="list-style-type: none"> evaluation of thermal resistor motor protection | | No |
| <ul style="list-style-type: none"> reset external | | Yes |
| <ul style="list-style-type: none"> adjustable current limitation | | Yes |
| <ul style="list-style-type: none"> inside-delta circuit | | No |
| Product component / outlet for enine brake | | No |
| Reference code | | |
| <ul style="list-style-type: none"> according to DIN EN 61346-2 | | Q |
| <ul style="list-style-type: none"> according to DIN 40719 extended according to IEC 204-2 / according to IEC 750 | | G |
| Power Electronics: | | |
| Product designation | | soft starters for standard applications |
| Operating current | | |

| | | |
|---|----|-------------|
| • at 40 °C / rated value | A | 230 |
| • at 50 °C / rated value | A | 205 |
| • at 60 °C / rated value | A | 180 |
| Emitted mechanical power / for three-phase servomotors | | |
| • at 230 V / at standard switching / at 40 °C | | |
| • rated value | W | 75,000 |
| • at 400 V / at standard switching / at 40 °C | | |
| • rated value | W | 132,000 |
| yielded mechanical performance (hp) / for three-phase squirrel cage motors / at 200/208 V / at standard circuit / at 50 °C / rated value | hp | 60 |
| Operating frequency | | |
| • rated value | Hz | 50 ... 60 |
| Relative negative tolerance / of the operating frequency | % | -10 |
| Relative positive tolerance / of the operating frequency | % | 10 |
| Operating voltage / with standard circuit / rated value | V | 200 ... 460 |
| Relative negative tolerance / of the operating voltage / with standard circuit | % | -15 |
| Relative positive tolerance / of the operating voltage / with standard circuit | % | 10 |
| Minimum load in % of I_M | % | 20 |
| Adjustable rated current / of the motor / for motor overload protection / minimum | A | 80 |
| Continuous operating current in % of I_e / at 40°C | % | 115 |
| Active power loss / at operating current / at 40°C / during operating phase / typical | W | 90 |

Control electronics:

| | | |
|--|----|-----|
| Voltage type / of control feed voltage | | AC |
| Control supply voltage frequency / 1 / rated value | Hz | 50 |
| Control supply voltage frequency / 2 / rated value | Hz | 60 |
| Relative negative tolerance / of the control supply voltage frequency | % | -10 |
| Relative positive tolerance / of the control supply voltage frequency | % | 10 |
| Control supply voltage / 1 | | |
| • at 50 Hz / for AC | V | 230 |
| • at 60 Hz / for AC | V | 230 |
| Relative negative tolerance / of the control supply voltage / at 60 Hz / for AC | % | -15 |
| Relative positive tolerance / of the control supply voltage / at 60 Hz / for AC | % | 10 |
| Type of display / for fault signal | | red |

| Mechanical design: | | |
|---|----|--|
| Size of the engine control device | | S12 |
| Width | mm | 160 |
| Height | mm | 230 |
| Depth | mm | 278 |
| Mounting type | | screw fixing |
| mounting position | | With additional fan: With vertical mounting surface +/- 90° rotatable, with vertical mounting surface +/- 22.5° tiltable to the front and back Without additional fan: With vertical mounting surface +/- 10° rotatable, with vertical mounting surface +/- 10° t |
| Distance, to be maintained, to the ranks assembly | | |
| • upwards | mm | 100 |
| • sideways | mm | 5 |
| • downwards | mm | 75 |
| Installation altitude / at a height over sea level | m | 5,000 |
| Cable length / maximum | m | 300 |
| Number of poles / for main current circuit | | 3 |









| Electrical connections: | | |
|---|--|--|
| Design of the electrical connection | | |
| • for main current circuit | | busbar connection |
| • for auxiliary and control current circuit | | spring-loaded terminals |
| Number of NC contacts / for auxiliary contacts | | 0 |
| Number of NO contacts / for auxiliary contacts | | 2 |
| Number of changeover contacts / for auxiliary contacts | | 1 |
| Type of the connectable conductor cross-section / for main contacts / for box terminal / when using the front clamping point | | |
| • finely stranded / with conductor end processing | | 70 ... 240 mm ² |
| • finely stranded / without conductor end processing | | 70 ... 240 mm ² |
| • stranded | | 95 ... 300 mm ² |
| Type of the connectable conductor cross-section / for main contacts / for box terminal / when using the back clamping point | | |
| • finely stranded / with conductor end processing | | 120 ... 185 mm ² |
| • without conductor final cutting / without conductor end processing | | 120 ... 185 mm ² |
| • stranded | | 120 ... 240 mm ² |
| Type of the connectable conductor cross-section / for main contacts / for box terminal / when using both clamping points | | |
| • finely stranded / with conductor end processing | | min. 2x 50 mm ² , max. 2x 185 mm ² |
| • without conductor final cutting / without conductor end processing | | min. 2x 50 mm ² , max. 2x 185 mm ² |

| | | |
|--|--|--|
| <ul style="list-style-type: none"> • stranded | | max. 2x 70 mm ² , max. 2x 240 mm ² |
| Type of the connectable conductor cross-section / for AWG conductors / for main contacts / for box terminal <ul style="list-style-type: none"> • when using the back cl • when using the front c • when using both clampi | | 250 ... 500 kcmil 3/0 ... 600 kcmil min. 2x 2/0, max. 2x 500 kcmil |
| Type of the connectable conductor cross-section / for DIN cable lug / for main contacts <ul style="list-style-type: none"> • finely stranded • stranded | | 50 ... 240 mm ² 70 ... 240 mm ² |
| Type of the connectable conductor cross-section <ul style="list-style-type: none"> • for AWG conductors / for main contacts | | 2/0 ... 500 kcmil |
| Type of the connectable conductor cross-section <ul style="list-style-type: none"> • for auxiliary contacts <ul style="list-style-type: none"> • solid • finely stranded / with conductor end processing • for AWG conductors / for auxiliary contacts | | 2x (0.25 ... 1.5 mm ²) 2x (0.25 ... 1.5 mm ²) 2x (24 ... 16) |

Ambient conditions:

| | | |
|---|----|-------------|
| Ambient temperature <ul style="list-style-type: none"> • during operating • during storage | °C | -25 ... +60 |
| | °C | -40 ... +80 |
| Derating temperature | °C | 40 |
| Protection class IP | | IP00 |

Certificates/approvals:

| | | | | | |
|--|--|---|--|---|---|
| General Product Approval | | | EMC | For use in hazardous locations | |
|  CCC |  CSA |  |  UL |  C-TICK |  ATEX |
| Test Certificates | Shipping Approval | | other | | |
| Special Test Certificate |  DNV |  GL |  LRS | Declaration of Conformity | Environmental Confirmations |

UL/CSA ratings

| | | |
|--|----|----|
| yielded mechanical performance (hp) / for three-phase squirrel cage motors <ul style="list-style-type: none"> • at 220/230 V / at standard circuit <ul style="list-style-type: none"> • at 50 °C / rated value • at 460/480 V / at standard circuit | hp | 75 |
|--|----|----|

• at 50 °C / rated value

hp 150

Contact rating designation / for auxiliary contacts / according to UL

B300 / R300

Further information:

Information- and Downloadcenter (Catalogs, Brochures,...)

<http://www.siemens.com/industrial-controls/catalogs>

Industry Mall (Online ordering system)

<http://www.siemens.com/industrial-controls/mall>

CAX-Online-Generator

<http://www.siemens.com/cax>

Service&Support (Manuals, Certificates, Characteristics, FAQs,...)

<http://support.automation.siemens.com/WW/view/en/3RW4073-2BB44/all>

Image database (product images, 2D dimension drawings, 3D models, device circuit diagrams, ...)

http://www.automation.siemens.com/bilddb/cax_en.aspx?mlfb=3RW4073-2BB44

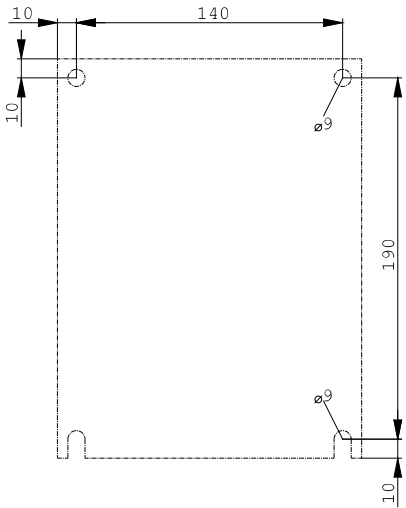
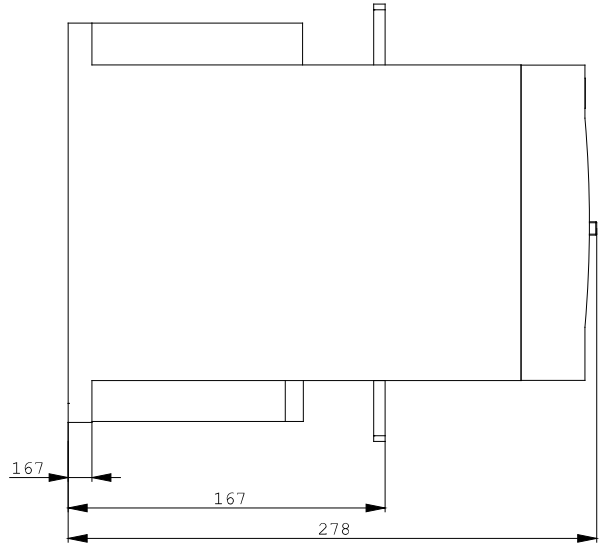
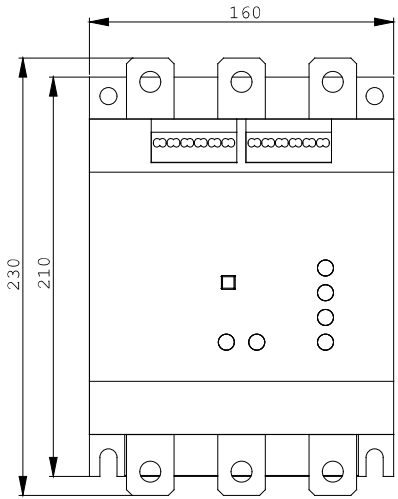

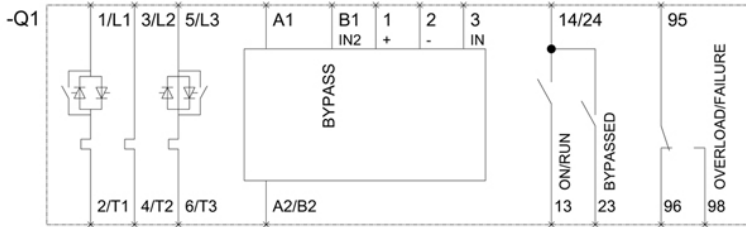

last change:

Jul 7, 2014