

Safety Standard Certified Ceramic Capacitors/ High Voltage Ceramic Capacitors

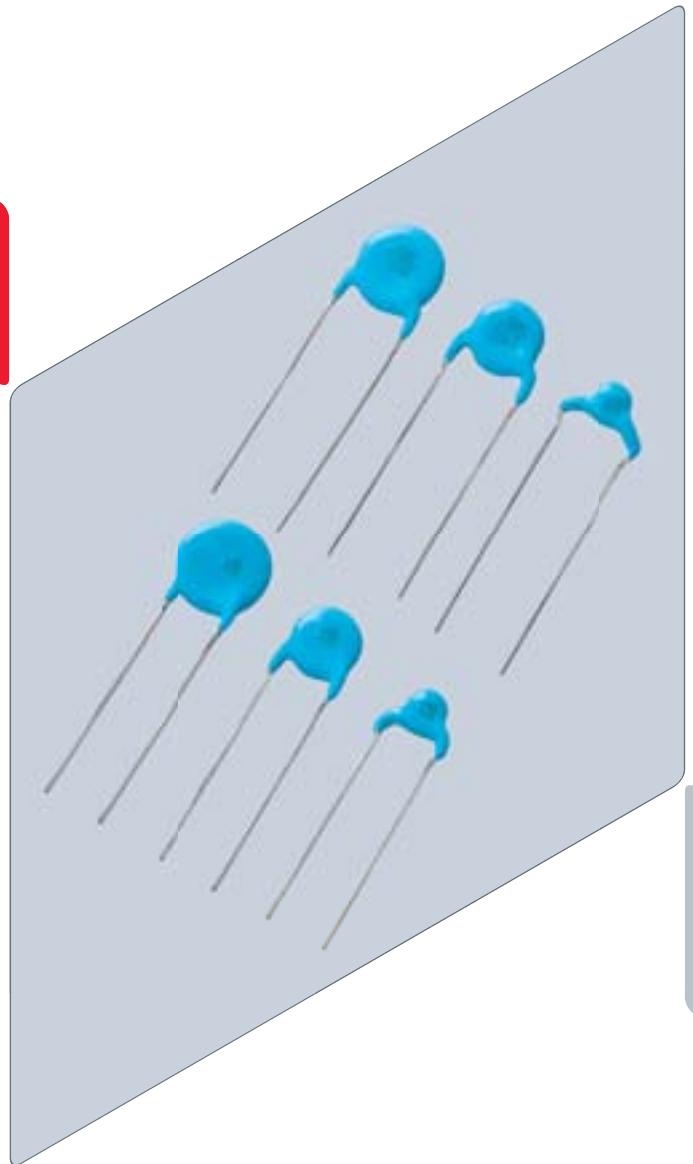



EU RoHS Compliant

- All the products in this catalog comply with EU RoHS.
- EU RoHS is "the European Directive 2011/65/EU on the Restriction of the Use of Certain Hazardous Substances in Electrical and Electronic Equipment."
- For more details, please refer to our website 'Murata's Approach for EU RoHS' (<http://www.murata.com/en-eu/support/compliance/rohs>).

Contents

Product specifications are as of March 2016.

Part Numbering	p2
<hr/>	
Safety Standard Certified Ceramic Capacitors	
1 Type KY (Basic Insulation) -Class X1, Y2- (Recommend)	p5
2 Type KX New Small Size (Reinforced Insulation) -Class X1, Y1- (Recommend)	p8
Type KY/KX Specifications and Test Methods	p11
<hr/>	
AC250V Ceramic Capacitor Non Safety Certified Type	
3 DEJ Series (Based on the Electrical Appliance and Material Safety Law of Japan)	p15
DEJ Series Specifications and Test Methods	p16
Safety Certified Ceramic Capacitors Characteristics Data (Typical Example)	p19
Safety Certified Ceramic Capacitors Packaging	p21
Safety Certified Ceramic Capacitors ⚠Caution	p23
Safety Certified Ceramic Capacitors Notice	p26
<hr/>	
High Voltage Ceramic Capacitors	
4 DEH Series (125°C Guaranteed/Low-dissipation Factor/DC2kV, 3.15kV)	p27
DEH Series Specifications and Test Methods	p29
5 DEA Series (125°C Guaranteed/Class 1/DC2k-3.15kV)	p31
DEA Series Specifications and Test Methods	p33
6 DEB Series (Class 2/DC2k-3.15kV)	p35
DEB Series Specifications and Test Methods	p37
7 DEC Series (Class 1, 2/DC6.3kV)	p39
DEC Series Specifications and Test Methods	p41
8 DEF Series (Only for LCD Backlight Inverter Circuit/6.3kVp-p)	p43
DEF Series Specifications and Test Methods	p45
High Voltage Ceramic Capacitors Characteristics Data (Typical Example)	p47
High Voltage Ceramic Capacitors Packaging	p48
High Voltage Ceramic Capacitors ⚠Caution	p50
High Voltage Ceramic Capacitors Notice	p55
<hr/>	
Safety Standard Certified Ceramic Capacitors for Automotive	
9 Type KJ -Class X1, Y2- (For Automotive Use/AC Line Filter of PHEV/EV Charger)	p56
Type KJ Specifications and Test Methods	p57
Safety Certified Ceramic Capacitors for Automotive Characteristics Data (Typical Example)	p61
Safety Certified Ceramic Capacitors for Automotive Packaging	p62
Safety Certified Ceramic Capacitors for Automotive ⚠Caution	p63
Safety Certified Ceramic Capacitors for Automotive Notice	p66
Safety Certified Ceramic Capacitors/High Voltage Ceramic Capacitors ISO9000 Certifications	p67

Please check the MURATA website (<http://www.murata.com/>) if you cannot find a part number in this catalog.

● Part Numbering

Safety Standard Certified Ceramic Capacitors

(Part Number)

DE	2	E3	KY	102	M	N3	A		F
①	②	③	④	⑤	⑥	⑦	⑧	⑨	⑩

① Product ID ② Series Category

Product ID	Code	Outline	Contents
DE	1	Safety Standard Certified	IEC60384-14 Class X1, Y1
	2		IEC60384-14 Class X1, Y2
	J	AC250V (r.m.s.)	-Products based on the Electrical Appliance and Material Safety Law of Japan-

For Electrical Appliance and Material Safety Law of Japan, the first three digits (①Product ID and ②Series Category) express "Series Name."

For Safety Certified Capacitors, the first three digits express product code. The fourth figure expresses certified type shown in ④Safety Standard Certified Type column.

③ Temperature Characteristics

Code	Temperature Characteristics	Cap. Change or Temp. Coeff.	Temperature Range
B3	B	±10%	-25 to +85°C
E3	E	+20%, -55%	
F3	F	+30%, -80%	
1X	SL	+350 to -1000ppm/°C	+20 to +85°C

④ Rated Voltage/Safety Standard Certified Type

Code	Rated Voltage
KX	X1, Y1; AC250V (r.m.s.), AC300V (r.m.s.) (Safety Standard Certified Type KX)
KY	X1, Y2; AC250V (r.m.s.), AC300V (r.m.s.) (Safety Standard Certified Type KY)
E2	AC250V (r.m.s.)

⑤ Capacitance

Expressed by three figures. The unit is pico-farad (pF). The first and second figures are significant digits, and the third figure expresses the number of zeros that follow the two numbers.

⑥ Capacitance Tolerance

Code	Capacitance Tolerance
J	±5%
K	±10%
M	±20%
Z	+80%, -20%

⑦ Lead Style

Code	Lead Style	Dimensions (mm)		
		Lead Spacing	Lead Diameter	Pitch of Components
A2	Vertical Crimp Long	5	ø0.6±0.05	—
A3		7.5		
A4		10		
B2/J2	Vertical Crimp Short	5	ø0.6±0.05	—
B3/J3		7.5		
B4/J4		10		
C3	Straight Long	7.5	ø0.6±0.05	—
D3	Straight Short	7.5	ø0.6±0.05	—
N2	Vertical Crimp Taping	5	ø0.6±0.05	12.7
N3		7.5		15
N4		10		25.4
P3	Straight Taping	7.5	ø0.6±0.05	15

⑧ Packaging

Code	Packaging
A	Ammo Pack Taping
B	Bulk

⑨ Individual Specification Code

For part number that cannot be identified without "Individual Specification," it is added at the end of part number, expressed by three-digit alphanumerics.

⑩ Halogen-free Compatible Product

High Voltage Ceramic Capacitors (2kV-6.3kV)

(Part Number)

DE	B	B3	3D	102	K	N2	A	
①	②	③	④	⑤	⑥	⑦	⑧	⑨

① Product ID ② Series Category

Product ID	Code	Outline	Contents
DE	A	High Voltage	Class 1 (Char. SL) DC2-3.15kV Rated
	B		Class 2 DC2-3.15kV Rated
	C		Class 1, 2 DC6.3kV Rated
	F		LCD Backlight Inverter Circuit 6.3kVp-p
	H		High Temperature Guaranteed, Low-dissipation Factor (Char. R) DC2-3.15kV Rated

The first three digits (①Product ID and ②Series Category) express "Series Name."

③ Temperature Characteristics

Code	Temperature Characteristics	Cap. Change or Temp. Coeff.	Temperature Range
B3	B	±10%	-25 to +85°C
E3	E	+20%, -55%	
F3	F	+30%, -80%	
R3	R	±15%	-25 to +85°C
		+15%, -30%	+85 to +125°C
D3	D	+20%, -30%	-25 to +125°C
1X	SL	+350 to -1000ppm/°C	+20 to +85°C
2C	CH	0±60ppm/°C	+20 to +85°C

④ Rated Voltage

Code	Rated Voltage
3D	DC2kV
3F	DC3.15kV
3J	DC6.3kV
LH	6.3kVp-p

⑤ Capacitance

Expressed by three figures. The unit is pico-farad (pF). The first and second figures are significant digits, and the third figure expresses the number of zeros that follow the two numbers.

⑥ Capacitance Tolerance

Code	Capacitance Tolerance
C	±0.25pF
D	±0.5pF
J	±5%
K	±10%
Z	+80%, -20%

⑦ Lead Style

Code	Lead Style	Dimensions (mm)		
		Lead Spacing	Lead Diameter	Pitch of Components
A2	Vertical Crimp Long	5	ø0.6±0.05	-
A3		7.5		
A4		10		
B2	Vertical Crimp Short	5	ø0.6±0.05	-
B3/J3		7.5		
B4		10		
C1	Straight Long	5	ø0.5±0.05	-
C3		7.5		
C4		10		
CD	Straight Short	7.5	ø0.5±0.05	-
D1		5		
D3		7.5		
DD	Vertical Crimp Taping	7.5	ø0.5±0.05	-
N2		5		
N3		7.5		
N7	Straight Taping	7.5	ø0.6±0.05	12.7
P2		5		
P3		7.5		

⑧ Packaging

Code	Packaging
A	Ammo Pack Taping
B	Bulk

⑨ Individual Specification Code

For part number that cannot be identified without "Individual Specification," it is added at the end of part number, expressed by three-digit alphanumerics.

Safety Standard Certified Ceramic Capacitors for Automotive

(Part Number)

DE	6	E3	KJ	102	M	N3	A	
①	②	③	④	⑤	⑥	⑦	⑧	⑨

① Product ID ② Series Category

Product ID	Code	Outline	Contents
DE	6	Safety Standard Certified	IEC60384-14 Class X1, Y2

The first three digits express product code. The fourth figure expresses certified type shown in ④ Safety Standard Certified Type column.

③ Temperature Characteristics

Code	Temperature Characteristics	Cap. Change or Temp. Coeff.	Temperature Range
B3	B	±10%	-25 to +85°C
E3	E	+20%, -55%	

④ Rated Voltage/Safety Standard Certified Type

Code	Rated Voltage
KJ	X1, Y2; AC300V (r.m.s.) (Safety Standard Certified Type KJ)

⑤ Capacitance

Expressed by three figures. The unit is pico-farad (pF). The first and second figures are significant digits, and the third figure expresses the number of zeros that follow the two numbers.

⑥ Capacitance Tolerance

Code	Capacitance Tolerance
K	±10%
M	±20%

⑦ Lead Style

Code	Lead Style	Dimensions (mm)		
		Lead Spacing	Lead Diameter	Pitch of Components
A3	Vertical Crimp Long	7.5	ø0.6±0.05	—
B3	Vertical Crimp Short			—
N3	Vertical Crimp Taping			15

⑧ Packaging

Code	Packaging
A	Ammo Pack Taping
B	Bulk

⑨ Individual Specification Code

For part number that cannot be identified without "Individual Specification," it is added at the end of part number, expressed by three-digit alphanumerics.

Safety Standard Certified Ceramic Capacitors

Type KY (Basic Insulation) -Class X1, Y2- (Recommend)

Features

1. Compact size; diameter 25% less than Type KH.
2. Operating temperature range guaranteed up to 125 degrees C.
3. Dielectric strength:
 AC2000V (for lead spacing F=5mm)
 AC2600V (for lead spacing F=7.5mm)
4. Class X1/Y2 capacitors certified by
 UL/CSA/VDE/BSI/SEMKO/DEMKO/FIMKO/NEMKO/
 ESTI/NSW/CQC.
5. Coated with flame-retardant epoxy resin
 (conforming to UL94V-0 standard).
 We recommend a halogen-free product* as our
 standard item.
 * Cl=900ppm max., Br=900ppm max. and
 Cl+Br=1500ppm max.
6. Taping available for automatic insertion.
7. AC300V Rated Voltage item are newly added.

Applications

1. Ideal for use as X/Y capacitors for AC line filters
 and primary-secondary coupling on switching power
 supplies and AC adapters.
2. Ideal for use on D-A isolation and noise absorption
 for DAA modems without transformers.

Do not use these products in any automotive power train or safety equipment including battery chargers for electric vehicles and plug-in hybrids. Only Murata products clearly stipulated as "for Automotive use" on its catalog can be used for automobile applications such as power train and safety equipment.

Standard Certification

	Standard No.	Certified No.	Rated Voltage
UL	UL60384-14	E37921	250Vac (r.m.s.)
CSA	CSA E60384-14	1283280	
VDE	IEC 60384-14 EN 60384-14	40006273	
BSI	EN 60065 (8.8, 14.2)	KM 37901	
	IEC 60384-14 EN 60384-14		
SEMKO	IEC 60384-14 EN 60384-14	1207848	
DEMKO		D01002	
FIMKO		24197	
NEMKO		P12215094	
ESTI		12.0102	
NSW	IEC 60384-14 AS3250	6824	
CQC	GB/T14472	CQC06001017446	
		CQC06001017447	

• The certification number might change due to revision of the application standard and changes in the range of acquisition.
 • Please contact us when the certification of South Korean Safety Standard is necessary.



[Bulk]
 Vertical Crimp Short (B2, B3)

[Bulk]
 Vertical Crimp Long (A2, A3)

• The certification number might change due to revision of the application standard and changes in the range of acquisition.

Marking

Example	Item
	① Type Designation KY
	② Nominal Capacitance (Under 100pF: Actual value, 100pF and over: 3 digit system)
	③ Capacitance Tolerance
	④ Company Name Code Ⓒ18: Made in Taiwan Ⓒ15: Made in Thailand
	⑤ Manufactured Date Code
	Class Code X1Y2
	Rated Voltage Mark 250~, 300~
	Halogen Free Mark HF

Rated Voltage 250Vac

Lead Spacing F=7.5mm

Part Number	AC Rated Voltage	Temp. Char.	Capacitance	Body Dia. D	Lead Spacing F (mm)	Body Thickness T	Lead Package Long Bulk	Lead Package Short Bulk	Lead Package Taping
DE21XKY100J□□□M02F	250Vac(r.m.s.)	SL	10pF±5%	8.0mm max.	7.5	5.0mm max.	A3B	B3B	N3A
DE21XKY150J□□□M02F	250Vac(r.m.s.)	SL	15pF±5%	8.0mm max.	7.5	5.0mm max.	A3B	B3B	N3A
DE21XKY220J□□□M02F	250Vac(r.m.s.)	SL	22pF±5%	8.0mm max.	7.5	5.0mm max.	A3B	B3B	N3A
DE21XKY330J□□□M02F	250Vac(r.m.s.)	SL	33pF±5%	8.0mm max.	7.5	5.0mm max.	A3B	B3B	N3A
DE21XKY470J□□□M02F	250Vac(r.m.s.)	SL	47pF±5%	8.0mm max.	7.5	5.0mm max.	A3B	B3B	N3A
DE21XKY680J□□□M02F	250Vac(r.m.s.)	SL	68pF±5%	8.0mm max.	7.5	5.0mm max.	A3B	B3B	N3A
DE2B3KY101K□□□M02F	250Vac(r.m.s.)	B	100pF±10%	7.0mm max.	7.5	5.0mm max.	A3B	B3B	N3A
DE2B3KY151K□□□M02F	250Vac(r.m.s.)	B	150pF±10%	7.0mm max.	7.5	5.0mm max.	A3B	B3B	N3A
DE2B3KY221K□□□M02F	250Vac(r.m.s.)	B	220pF±10%	7.0mm max.	7.5	5.0mm max.	A3B	B3B	N3A
DE2B3KY331K□□□M02F	250Vac(r.m.s.)	B	330pF±10%	7.0mm max.	7.5	5.0mm max.	A3B	B3B	N3A
DE2B3KY471K□□□M02F	250Vac(r.m.s.)	B	470pF±10%	7.0mm max.	7.5	5.0mm max.	A3B	B3B	N3A
DE2B3KY681K□□□M02F	250Vac(r.m.s.)	B	680pF±10%	8.0mm max.	7.5	5.0mm max.	A3B	B3B	N3A
DE2E3KY102M□□□M02F	250Vac(r.m.s.)	E	1000pF±20%	7.0mm max.	7.5	5.0mm max.	A3B	B3B	N3A
DE2E3KY152M□□□M02F	250Vac(r.m.s.)	E	1500pF±20%	7.0mm max.	7.5	5.0mm max.	A3B	B3B	N3A
DE2E3KY222M□□□M02F	250Vac(r.m.s.)	E	2200pF±20%	8.0mm max.	7.5	5.0mm max.	A3B	B3B	N3A
DE2E3KY332M□□□M02F	250Vac(r.m.s.)	E	3300pF±20%	9.0mm max.	7.5	5.0mm max.	A3B	B3B	N3A
DE2E3KY472M□□□M02F	250Vac(r.m.s.)	E	4700pF±20%	10.0mm max.	7.5	5.0mm max.	A3B	B3B	N3A
DE2F3KY103M□□□M02F	250Vac(r.m.s.)	F	10000pF±20%	14.0mm max.	7.5	5.0mm max.	A3B	B3B	N3A

Three blank columns are filled with the lead and packaging codes. Please refer to the 3 columns on the right for the appropriate code.

Individual specification code "M02" expresses "simplicity marking and guarantee of dielectric strength between lead wires: AC2600V."

Murata part numbers might be changed depending on lead code or any other changes. Therefore, please specify only the type name (KY) and capacitance of products in the parts list when it is required for applying safety standard of electric equipment.

Lead Spacing F=5mm

Part Number	AC Rated Voltage	Temp. Char.	Capacitance	Body Dia. D	Lead Spacing F (mm)	Body Thickness T	Lead Package Long Bulk	Lead Package Short Bulk	Lead Package Taping
DE21XKY100J□□□M01F	250Vac(r.m.s.)	SL	10pF±5%	8.0mm max.	5.0	5.0mm max.	A2B	B2B	N2A
DE21XKY150J□□□M01F	250Vac(r.m.s.)	SL	15pF±5%	8.0mm max.	5.0	5.0mm max.	A2B	B2B	N2A
DE21XKY220J□□□M01F	250Vac(r.m.s.)	SL	22pF±5%	8.0mm max.	5.0	5.0mm max.	A2B	B2B	N2A
DE21XKY330J□□□M01F	250Vac(r.m.s.)	SL	33pF±5%	8.0mm max.	5.0	5.0mm max.	A2B	B2B	N2A
DE21XKY470J□□□M01F	250Vac(r.m.s.)	SL	47pF±5%	8.0mm max.	5.0	5.0mm max.	A2B	B2B	N2A
DE21XKY680J□□□M01F	250Vac(r.m.s.)	SL	68pF±5%	8.0mm max.	5.0	5.0mm max.	A2B	B2B	N2A
DE2B3KY101K□□□M01F	250Vac(r.m.s.)	B	100pF±10%	7.0mm max.	5.0	5.0mm max.	A2B	B2B	N2A
DE2B3KY151K□□□M01F	250Vac(r.m.s.)	B	150pF±10%	7.0mm max.	5.0	5.0mm max.	A2B	B2B	N2A
DE2B3KY221K□□□M01F	250Vac(r.m.s.)	B	220pF±10%	7.0mm max.	5.0	5.0mm max.	A2B	B2B	N2A
DE2B3KY331K□□□M01F	250Vac(r.m.s.)	B	330pF±10%	7.0mm max.	5.0	5.0mm max.	A2B	B2B	N2A
DE2B3KY471K□□□M01F	250Vac(r.m.s.)	B	470pF±10%	7.0mm max.	5.0	5.0mm max.	A2B	B2B	N2A
DE2B3KY681K□□□M01F	250Vac(r.m.s.)	B	680pF±10%	8.0mm max.	5.0	5.0mm max.	A2B	B2B	N2A
DE2E3KY102M□□□M01F	250Vac(r.m.s.)	E	1000pF±20%	7.0mm max.	5.0	5.0mm max.	A2B	B2B	N2A

Continued on the following page. ↗

Continued from the preceding page. ↘

Part Number	AC Rated Voltage	Temp. Char.	Capacitance	Body Dia. D	Lead Spacing F (mm)	Body Thickness T	Lead Package Long Bulk	Lead Package Short Bulk	Lead Package Taping
DE2E3KY152M□□□M01F	250Vac(r.m.s.)	E	1500pF±20%	7.0mm max.	5.0	5.0mm max.	A2B	B2B	N2A
DE2E3KY222M□□□M01F	250Vac(r.m.s.)	E	2200pF±20%	8.0mm max.	5.0	5.0mm max.	A2B	B2B	N2A
DE2E3KY332M□□□M01F	250Vac(r.m.s.)	E	3300pF±20%	9.0mm max.	5.0	5.0mm max.	A2B	B2B	N2A
DE2E3KY472M□□□M01F	250Vac(r.m.s.)	E	4700pF±20%	10.0mm max.	5.0	5.0mm max.	A2B	B2B	N2A

Three blank columns are filled with the lead and packaging codes. Please refer to the 3 columns on the right for the appropriate code.
 Individual specification code "M01" expresses "simplicity marking and guarantee of dielectric strength between lead wires: AC2000V."
 Murata part numbers might be changed depending on lead code or any other changes. Therefore, please specify only the type name (KY) and capacitance of products in the parts list when it is required for applying safety standard of electric equipment.

Rated Voltage 300Vac

Lead Spacing F=7.5mm

Part Number	AC Rated Voltage	Temp. Char.	Capacitance	Body Dia. D	Lead Spacing F (mm)	Body Thickness T	Lead Package Long Bulk	Lead Package Short Bulk	Lead Package Taping
DE2B3KY101K□□□U02F	300Vac(r.m.s.)	B	100pF±10%	7.0mm max.	7.5	5.0mm max.	A3B	B3B	N3A
DE2B3KY151K□□□U02F	300Vac(r.m.s.)	B	150pF±10%	7.0mm max.	7.5	5.0mm max.	A3B	B3B	N3A
DE2B3KY221K□□□U02F	300Vac(r.m.s.)	B	220pF±10%	7.0mm max.	7.5	5.0mm max.	A3B	B3B	N3A
DE2B3KY331K□□□U02F	300Vac(r.m.s.)	B	330pF±10%	7.0mm max.	7.5	5.0mm max.	A3B	B3B	N3A
DE2B3KY471K□□□U02F	300Vac(r.m.s.)	B	470pF±10%	7.0mm max.	7.5	5.0mm max.	A3B	B3B	N3A
DE2B3KY681K□□□U02F	300Vac(r.m.s.)	B	680pF±10%	8.0mm max.	7.5	5.0mm max.	A3B	B3B	N3A
DE2E3KY102M□□□U02F	300Vac(r.m.s.)	E	1000pF±20%	7.0mm max.	7.5	5.0mm max.	A3B	B3B	N3A
DE2E3KY152M□□□U02F	300Vac(r.m.s.)	E	1500pF±20%	7.0mm max.	7.5	5.0mm max.	A3B	B3B	N3A
DE2E3KY222M□□□U02F	300Vac(r.m.s.)	E	2200pF±20%	8.0mm max.	7.5	5.0mm max.	A3B	B3B	N3A
DE2E3KY332M□□□U02F	300Vac(r.m.s.)	E	3300pF±20%	9.0mm max.	7.5	5.0mm max.	A3B	B3B	N3A
DE2E3KY472M□□□U02F	300Vac(r.m.s.)	E	4700pF±20%	10.0mm max.	7.5	5.0mm max.	A3B	B3B	N3A
DE2F3KY103M□□□U02F	300Vac(r.m.s.)	F	10000pF±20%	14.0mm max.	7.5	5.0mm max.	A3B	B3B	N3A

Three blank columns are filled with the lead and packaging codes. Please refer to the 3 columns on the right for the appropriate code.
 Individual specification code "U02" expresses "simplicity marking and guarantee of dielectric strength between lead wires: AC2600V."
 Murata part numbers might be changed depending on lead code or any other changes. Therefore, please specify only the type name (KY) and capacitance of products in the parts list when it is required for applying safety standard of electric equipment.

Safety Standard Certified Ceramic Capacitors

Type KX New Small Size (Reinforced Insulation) -Class X1, Y1- (Recommend)

2

Features

1. We design capacitors much more compact in size than current Type KX, having reduced the diameter by 20% max.
2. Operating temperature range guaranteed up to 125 degrees C.
3. Dielectric strength: AC4000V
4. Class X1/Y1 capacitors certified by UL/CSA/VDE/BSI/SEMKO/DEMKO/FIMKO/NEMKO/ESTI/IMQ/CQC.
5. Can be use with a component in appliances requiring reinforced insulation and double insulation based on UL1492, IEC60065 and IEC60950.
6. Coated with flame-retardant epoxy resin (conforming to UL94V-0 standard).
 We recommend a halogen-free product* as our standard item.
 * Cl=900ppm max., Br=900ppm max. and Cl+Br=1500ppm max.
7. Taping available for automatic insertion.
8. AC300V Rated Voltage item are newly added.

Applications

1. Ideal for use as X/Y capacitors for AC line filters and primary-secondary coupling on switching power supplies and AC adapters.
2. Ideal for use on D-A isolation and noise absorption for DAA modems without transformers.

Do not use these products in any automotive power train or safety equipment including battery chargers for electric vehicles and plug-in hybrids. Only Murata products clearly stipulated as "for Automotive use" on its catalog can be used for automobile applications such as power train and safety equipment.

*: Small sized Type KX differs from current Type KX in electrical characteristics, such as the voltage dependency, capacitance temperature dependency, and Dielectric strength.
 Therefore, before replacing current Type KX, please make a performance check by equipment.
 Please also refer to Notice (Rating) item 2, "Performance Check by Equipment," below.

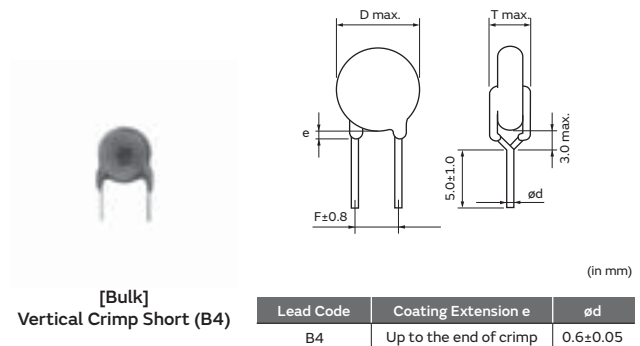

Standard Certification Rated Voltage (AC250V) B, E Char.

	Standard No.	Certified No.
UL	UL60384-14	E37921
CSA	CSA E60384-14	1343810
VDE	IEC 60384-14 EN 60384-14	40002831
BSI	EN 60065 (8.8, 14.2) IEC 60384-14 EN 60384-14	KM 37901
SEMKO		1200074
DEMKO	IEC 60384-14	D01004
FIMKO	EN 60384-14	24191
NEMKO		P12215096
ESTI		12.0094
IMQ	EN 60384-14	V4069
CQC	GB/T14472	CQC02001001556 CQC04001011643

- The certification number might change due to revision of the application standard and changes in the range of acquisition.
- Please contact us when the certification of South Korean Safety Standard is necessary.

Standard Certification Rated Voltage (AC300V) B, E Char.

	Standard No.	Certified No.
UL	UL60384-14	E37921
CSA	CSA E60384-14	1343810
VDE	IEC 60384-14 EN 60384-14	40002831
BSI	EN 60065 (8.8, 14.2) IEC 60384-14 EN 60384-14	KM 37901
SEMKO		1200074
DEMKO	IEC 60384-14	D01004
FIMKO	EN 60384-14	24191
NEMKO		P12215096
ESTI		12.0094
IMQ	EN 60384-14	V4069
CQC	IEC 60384-14	CQC12001079735 CQC12001079941

- The certification number might change due to revision of the application standard and changes in the range of acquisition.

Marking Rated Voltage (AC250V) B, E Char.

Example	Item
	① Type Designation KX
	② Nominal Capacitance (3 digit system)
	③ Capacitance Tolerance
	④ Company Name Code Ⓜ8: Made in Taiwan Ⓜ15: Made in Thailand
	⑤ Manufactured Date Code
	Class Code X1Y1
	Rated Voltage Mark 250~
	Halogen Free Mark HF

Marking Rated Voltage (AC300V) B, E Char.

Example	Item
	① Type Designation KX
	② Nominal Capacitance (3 digit system)
	③ Capacitance Tolerance
	④ Company Name Code Ⓜ8: Made in Taiwan Ⓜ15: Made in Thailand
	⑤ Manufactured Date Code
	Class Code X1Y1
	Rated Voltage Mark 300~
	Halogen Free Mark HF

Rated Voltage 250Vac

Part Number	AC Rated Voltage	Temp. Char.	Capacitance	Body Dia. D	Lead Spacing F (mm)	Body Thickness T	Lead Package Long Bulk	Lead Package Short Bulk	Lead Package Taping
DE1B3KX101K□□□N01F	250Vac(r.m.s.)	B	100pF±10%	7.0mm max.	10.0	7.0mm max.	A4B	B4B	N4A
DE1B3KX151K□□□N01F	250Vac(r.m.s.)	B	150pF±10%	7.0mm max.	10.0	7.0mm max.	A4B	B4B	N4A
DE1B3KX221K□□□N01F	250Vac(r.m.s.)	B	220pF±10%	8.0mm max.	10.0	7.0mm max.	A4B	B4B	N4A
DE1B3KX331K□□□N01F	250Vac(r.m.s.)	B	330pF±10%	7.0mm max.	10.0	7.0mm max.	A4B	B4B	N4A
DE1B3KX471K□□□N01F	250Vac(r.m.s.)	B	470pF±10%	7.0mm max.	10.0	7.0mm max.	A4B	B4B	N4A
DE1B3KX681K□□□N01F	250Vac(r.m.s.)	B	680pF±10%	8.0mm max.	10.0	7.0mm max.	A4B	B4B	N4A
DE1E3KX102M□□□N01F	250Vac(r.m.s.)	E	1000pF±20%	7.0mm max.	10.0	7.0mm max.	A4B	B4B	N4A
DE1E3KX152M□□□N01F	250Vac(r.m.s.)	E	1500pF±20%	8.0mm max.	10.0	7.0mm max.	A4B	B4B	N4A
DE1E3KX222M□□□N01F	250Vac(r.m.s.)	E	2200pF±20%	9.0mm max.	10.0	7.0mm max.	A4B	B4B	N4A
DE1E3KX332M□□□N01F	250Vac(r.m.s.)	E	3300pF±20%	10.0mm max.	10.0	7.0mm max.	A4B	B4B	N4A
DE1E3KX472M□□□N01F	250Vac(r.m.s.)	E	4700pF±20%	12.0mm max.	10.0	7.0mm max.	A4B	B4B	N4A

Three blank columns are filled with the lead and packaging codes. Please refer to the 3 columns on the right for the appropriate code.

Murata part numbers might be changed depending on lead code or any other changes. Therefore, please specify only the type name (KX) and capacitance of products in the parts list when it is required for applying safety standard of electric equipment.

Please contact us when less than 100pF capacitance product is necessary.

Rated Voltage 300Vac

Part Number	AC Rated Voltage	Temp. Char.	Capacitance	Body Dia. D	Lead Spacing F (mm)	Body Thickness T	Lead Package Long Bulk	Lead Package Short Bulk	Lead Package Taping
DE1B3KX101K□□□P01F	300Vac(r.m.s.)	B	100pF±10%	7.0mm max.	10.0	7.0mm max.	A4B	B4B	N4A
DE1B3KX151K□□□P01F	300Vac(r.m.s.)	B	150pF±10%	7.0mm max.	10.0	7.0mm max.	A4B	B4B	N4A
DE1B3KX221K□□□P01F	300Vac(r.m.s.)	B	220pF±10%	8.0mm max.	10.0	7.0mm max.	A4B	B4B	N4A
DE1B3KX331K□□□P01F	300Vac(r.m.s.)	B	330pF±10%	7.0mm max.	10.0	7.0mm max.	A4B	B4B	N4A
DE1B3KX471K□□□P01F	300Vac(r.m.s.)	B	470pF±10%	7.0mm max.	10.0	7.0mm max.	A4B	B4B	N4A
DE1B3KX681K□□□P01F	300Vac(r.m.s.)	B	680pF±10%	8.0mm max.	10.0	7.0mm max.	A4B	B4B	N4A
DE1E3KX102M□□□P01F	300Vac(r.m.s.)	E	1000pF±20%	7.0mm max.	10.0	7.0mm max.	A4B	B4B	N4A
DE1E3KX152M□□□P01F	300Vac(r.m.s.)	E	1500pF±20%	8.0mm max.	10.0	7.0mm max.	A4B	B4B	N4A
DE1E3KX222M□□□P01F	300Vac(r.m.s.)	E	2200pF±20%	9.0mm max.	10.0	7.0mm max.	A4B	B4B	N4A
DE1E3KX332M□□□P01F	300Vac(r.m.s.)	E	3300pF±20%	10.0mm max.	10.0	7.0mm max.	A4B	B4B	N4A
DE1E3KX472M□□□P01F	300Vac(r.m.s.)	E	4700pF±20%	12.0mm max.	10.0	7.0mm max.	A4B	B4B	N4A

Three blank columns are filled with the lead and packaging codes. Please refer to the 3 columns on the right for the appropriate code.

Murata part numbers might be changed depending on lead code or any other changes. Therefore, please specify only the type name (KX) and capacitance of products in the parts list when it is required for applying safety standard of electric equipment.

Type KY/KX Specifications and Test Methods

Operating Temperature Range: -40 to +125°C (Except for UL/VDE, -25 to +125°C)

No.	Item	Specifications	Test Method																								
1	Appearance and Dimensions	No visible defect, and dimensions are within specified range.	The capacitor should be visually inspected for evidence of defect. Dimensions should be measured with slide calipers.																								
2	Marking	To be easily legible	The capacitor should be visually inspected.																								
3	Capacitance	Within specified tolerance	The capacitance, dissipation factor and Q should be measured at 20°C with 1±0.1kHz (char. SL: 1±0.1MHz) and AC5V(r.m.s.) max.																								
4	Dissipation Factor (D.F.) Q	<table border="1" style="width: 100%; border-collapse: collapse; margin-bottom: 5px;"> <thead> <tr style="background-color: #444; color: white;"> <th>Char.</th> <th>Specifications</th> </tr> </thead> <tbody> <tr> <td>B, E</td> <td>D.F. ≤2.5%</td> </tr> <tr> <td>F</td> <td>D.F. ≤5.0%</td> </tr> <tr> <td>SL</td> <td>Q ≥ 400+20C*1 (C < 30pF) Q ≥ 1000 (C ≥ 30pF)</td> </tr> </tbody> </table>		Char.	Specifications	B, E	D.F. ≤2.5%	F	D.F. ≤5.0%	SL	Q ≥ 400+20C*1 (C < 30pF) Q ≥ 1000 (C ≥ 30pF)																
Char.	Specifications																										
B, E	D.F. ≤2.5%																										
F	D.F. ≤5.0%																										
SL	Q ≥ 400+20C*1 (C < 30pF) Q ≥ 1000 (C ≥ 30pF)																										
5	Insulation Resistance (I.R.)	10000MΩ min.	The insulation resistance should be measured with DC500±50V within 60±5 sec. of charging. The voltage should be applied to the capacitor through a resistor of 1MΩ.																								
6	Between Lead Wires	No failure	The capacitor should not be damaged when the test voltages from Table 1 are applied between the lead wires for 60 sec. <div style="text-align: center;"><Table 1></div> <table border="1" style="width: 100%; border-collapse: collapse; margin-bottom: 5px;"> <thead> <tr style="background-color: #444; color: white;"> <th>Type</th> <th>Test Voltage</th> </tr> </thead> <tbody> <tr> <td>KY</td> <td>For lead spacing F=5mm AC2000V(r.m.s.) For lead spacing F=7.5mm AC2600V(r.m.s.)</td> </tr> <tr> <td>KX</td> <td>AC4000V(r.m.s.)</td> </tr> </tbody> </table>	Type	Test Voltage	KY	For lead spacing F=5mm AC2000V(r.m.s.) For lead spacing F=7.5mm AC2600V(r.m.s.)	KX	AC4000V(r.m.s.)																		
	Type	Test Voltage																									
KY	For lead spacing F=5mm AC2000V(r.m.s.) For lead spacing F=7.5mm AC2600V(r.m.s.)																										
KX	AC4000V(r.m.s.)																										
Dielectric Strength	Body Insulation	No failure	First, the terminals of the capacitor should be connected together. Then, as shown in the figure at right, a metal foil should be closely wrapped around the body of the capacitor to the distance of about 3 to 6mm from each terminal.  Then, the capacitor should be inserted into a container filled with metal balls of about 1mm diameter. Finally, AC voltage from Table 2 is applied for 60 sec. between the capacitor lead wires and metal balls. <div style="text-align: center;"><Table 2></div> <table border="1" style="width: 100%; border-collapse: collapse; margin-bottom: 5px;"> <thead> <tr style="background-color: #444; color: white;"> <th>Type</th> <th>Test Voltage</th> </tr> </thead> <tbody> <tr> <td>KY</td> <td>AC2600V(r.m.s.)</td> </tr> <tr> <td>KX</td> <td>AC4000V(r.m.s.)</td> </tr> </tbody> </table>	Type	Test Voltage	KY	AC2600V(r.m.s.)	KX	AC4000V(r.m.s.)																		
Type	Test Voltage																										
KY	AC2600V(r.m.s.)																										
KX	AC4000V(r.m.s.)																										
7	Temperature Characteristics	<table border="1" style="width: 100%; border-collapse: collapse; margin-bottom: 5px;"> <thead> <tr style="background-color: #444; color: white;"> <th>Char.</th> <th>Capacitance Change</th> </tr> </thead> <tbody> <tr> <td>B</td> <td>Within ±10%</td> </tr> <tr> <td>E</td> <td>Within $\pm\frac{20}{55}\%$</td> </tr> <tr> <td>F</td> <td>Within $\pm\frac{30}{30}\%$</td> </tr> </tbody> </table> (Temp. range: -25 to +85°C) <table border="1" style="width: 100%; border-collapse: collapse; margin-bottom: 5px;"> <thead> <tr style="background-color: #444; color: white;"> <th>Char.</th> <th>Temperature Coefficient</th> </tr> </thead> <tbody> <tr> <td>SL</td> <td>+350 to -1000ppm/°C</td> </tr> </tbody> </table> (Temp. range: +20 to +85°C)	Char.	Capacitance Change	B	Within ±10%	E	Within $\pm\frac{20}{55}\%$	F	Within $\pm\frac{30}{30}\%$	Char.	Temperature Coefficient	SL	+350 to -1000ppm/°C	The capacitance measurement should be made at each step specified in Table 3. <div style="text-align: center;"><Table 3></div> <table border="1" style="width: 100%; border-collapse: collapse; margin-bottom: 5px;"> <thead> <tr style="background-color: #444; color: white;"> <th>Step</th> <th>Temperature (°C)</th> </tr> </thead> <tbody> <tr> <td>1</td> <td>20±2</td> </tr> <tr> <td>2</td> <td>-25±2</td> </tr> <tr> <td>3</td> <td>20±2</td> </tr> <tr> <td>4</td> <td>85±2</td> </tr> <tr> <td>5</td> <td>20±2</td> </tr> </tbody> </table>	Step	Temperature (°C)	1	20±2	2	-25±2	3	20±2	4	85±2	5	20±2
Char.	Capacitance Change																										
B	Within ±10%																										
E	Within $\pm\frac{20}{55}\%$																										
F	Within $\pm\frac{30}{30}\%$																										
Char.	Temperature Coefficient																										
SL	+350 to -1000ppm/°C																										
Step	Temperature (°C)																										
1	20±2																										
2	-25±2																										
3	20±2																										
4	85±2																										
5	20±2																										
8	Solderability of Leads	Lead wire should be soldered with uniform coating on the axial direction over 3/4 of the circumferential direction.	The lead wire of a capacitor should be dipped into molten solder for 2±0.5 sec. The depth of immersion is up to about 1.5 to 2.0mm from the root of lead wires. Temp. of solder: Lead Free Solder (Sn-3Ag-0.5Cu) 245±5°C H63 Eutectic Solder 235±5°C																								

*1 "C" expresses nominal capacitance value (pF).

Continued on the following page. ↗

Type KY/KX Specifications and Test Methods

Continued from the preceding page.

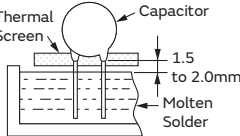
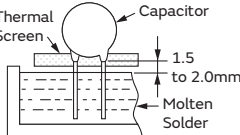
No.	Item	Specifications	Test Method								
9	Soldering Effect (Non-Preheat)	Appearance	No marked defect								
		Capacitance Change	Within $\pm 10\%$								
		I.R.	1000M Ω min.								
		Dielectric Strength	Per Item 6								
10	Soldering Effect (On-Preheat)	Appearance	No marked defect								
		Capacitance Change	Within $\pm 10\%$								
		I.R.	1000M Ω min.								
		Dielectric Strength	Per Item 6								
11	Vibration Resistance	Appearance	No marked defect								
		Capacitance	Within the specified tolerance								
		D.F.	<table border="1"> <thead> <tr> <th>Char.</th> <th>Specifications</th> </tr> </thead> <tbody> <tr> <td>B, E</td> <td>D.F. $\leq 2.5\%$</td> </tr> <tr> <td>F</td> <td>D.F. $\leq 5.0\%$</td> </tr> <tr> <td>SL</td> <td>Q $\geq 400 + 20C^{*1}$ (C < 30pF) Q ≥ 1000 (C ≥ 30pF)</td> </tr> </tbody> </table>	Char.	Specifications	B, E	D.F. $\leq 2.5\%$	F	D.F. $\leq 5.0\%$	SL	Q $\geq 400 + 20C^{*1}$ (C < 30pF) Q ≥ 1000 (C ≥ 30 pF)
		Char.	Specifications								
B, E	D.F. $\leq 2.5\%$										
F	D.F. $\leq 5.0\%$										
SL	Q $\geq 400 + 20C^{*1}$ (C < 30pF) Q ≥ 1000 (C ≥ 30 pF)										
Q	<table border="1"> <thead> <tr> <th>Char.</th> <th>Specifications</th> </tr> </thead> <tbody> <tr> <td>B, E</td> <td>D.F. $\leq 2.5\%$</td> </tr> <tr> <td>F</td> <td>D.F. $\leq 5.0\%$</td> </tr> <tr> <td>SL</td> <td>Q $\geq 400 + 20C^{*1}$ (C < 30pF) Q ≥ 1000 (C ≥ 30pF)</td> </tr> </tbody> </table>	Char.	Specifications	B, E	D.F. $\leq 2.5\%$	F	D.F. $\leq 5.0\%$	SL	Q $\geq 400 + 20C^{*1}$ (C < 30pF) Q ≥ 1000 (C ≥ 30 pF)		
Char.	Specifications										
B, E	D.F. $\leq 2.5\%$										
F	D.F. $\leq 5.0\%$										
SL	Q $\geq 400 + 20C^{*1}$ (C < 30pF) Q ≥ 1000 (C ≥ 30 pF)										
12	Humidity (Under Steady State)	Appearance	No marked defect								
		Capacitance Change	<table border="1"> <thead> <tr> <th>Char.</th> <th>Capacitance Change</th> </tr> </thead> <tbody> <tr> <td>B</td> <td>Within $\pm 10\%$</td> </tr> <tr> <td>E, F</td> <td>Within $\pm 15\%$</td> </tr> <tr> <td>SL</td> <td>Within $\pm 5\%$</td> </tr> </tbody> </table>	Char.	Capacitance Change	B	Within $\pm 10\%$	E, F	Within $\pm 15\%$	SL	Within $\pm 5\%$
		Char.	Capacitance Change								
		B	Within $\pm 10\%$								
		E, F	Within $\pm 15\%$								
SL	Within $\pm 5\%$										
D.F.	<table border="1"> <thead> <tr> <th>Char.</th> <th>Specifications</th> </tr> </thead> <tbody> <tr> <td>B, E</td> <td>D.F. $\leq 5.0\%$</td> </tr> <tr> <td>F</td> <td>D.F. $\leq 7.5\%$</td> </tr> <tr> <td>SL</td> <td>Q $\geq 275 + 5/2C^{*1}$ (C < 30pF) Q ≥ 350 (C ≥ 30pF)</td> </tr> </tbody> </table>	Char.	Specifications	B, E	D.F. $\leq 5.0\%$	F	D.F. $\leq 7.5\%$	SL	Q $\geq 275 + 5/2C^{*1}$ (C < 30pF) Q ≥ 350 (C ≥ 30 pF)		
Char.	Specifications										
B, E	D.F. $\leq 5.0\%$										
F	D.F. $\leq 7.5\%$										
SL	Q $\geq 275 + 5/2C^{*1}$ (C < 30pF) Q ≥ 350 (C ≥ 30 pF)										
Q	<table border="1"> <thead> <tr> <th>Char.</th> <th>Specifications</th> </tr> </thead> <tbody> <tr> <td>B, E</td> <td>D.F. $\leq 5.0\%$</td> </tr> <tr> <td>F</td> <td>D.F. $\leq 7.5\%$</td> </tr> <tr> <td>SL</td> <td>Q $\geq 275 + 5/2C^{*1}$ (C < 30pF) Q ≥ 350 (C ≥ 30pF)</td> </tr> </tbody> </table>	Char.	Specifications	B, E	D.F. $\leq 5.0\%$	F	D.F. $\leq 7.5\%$	SL	Q $\geq 275 + 5/2C^{*1}$ (C < 30pF) Q ≥ 350 (C ≥ 30 pF)		
Char.	Specifications										
B, E	D.F. $\leq 5.0\%$										
F	D.F. $\leq 7.5\%$										
SL	Q $\geq 275 + 5/2C^{*1}$ (C < 30pF) Q ≥ 350 (C ≥ 30 pF)										
I.R.	3000M Ω min.										
13	Humidity Loading	Appearance	No marked defect								
		Capacitance Change	<table border="1"> <thead> <tr> <th>Char.</th> <th>Capacitance Change</th> </tr> </thead> <tbody> <tr> <td>B</td> <td>Within $\pm 10\%$</td> </tr> <tr> <td>E, F</td> <td>Within $\pm 15\%$</td> </tr> <tr> <td>SL</td> <td>Within $\pm 5\%$</td> </tr> </tbody> </table>	Char.	Capacitance Change	B	Within $\pm 10\%$	E, F	Within $\pm 15\%$	SL	Within $\pm 5\%$
		Char.	Capacitance Change								
		B	Within $\pm 10\%$								
		E, F	Within $\pm 15\%$								
SL	Within $\pm 5\%$										
D.F.	<table border="1"> <thead> <tr> <th>Char.</th> <th>Specifications</th> </tr> </thead> <tbody> <tr> <td>B, E</td> <td>D.F. $\leq 5.0\%$</td> </tr> <tr> <td>F</td> <td>D.F. $\leq 7.5\%$</td> </tr> <tr> <td>SL</td> <td>Q $\geq 275 + 5/2C^{*1}$ (C < 30pF) Q ≥ 350 (C ≥ 30pF)</td> </tr> </tbody> </table>	Char.	Specifications	B, E	D.F. $\leq 5.0\%$	F	D.F. $\leq 7.5\%$	SL	Q $\geq 275 + 5/2C^{*1}$ (C < 30pF) Q ≥ 350 (C ≥ 30 pF)		
Char.	Specifications										
B, E	D.F. $\leq 5.0\%$										
F	D.F. $\leq 7.5\%$										
SL	Q $\geq 275 + 5/2C^{*1}$ (C < 30pF) Q ≥ 350 (C ≥ 30 pF)										
Q	<table border="1"> <thead> <tr> <th>Char.</th> <th>Specifications</th> </tr> </thead> <tbody> <tr> <td>B, E</td> <td>D.F. $\leq 5.0\%$</td> </tr> <tr> <td>F</td> <td>D.F. $\leq 7.5\%$</td> </tr> <tr> <td>SL</td> <td>Q $\geq 275 + 5/2C^{*1}$ (C < 30pF) Q ≥ 350 (C ≥ 30pF)</td> </tr> </tbody> </table>	Char.	Specifications	B, E	D.F. $\leq 5.0\%$	F	D.F. $\leq 7.5\%$	SL	Q $\geq 275 + 5/2C^{*1}$ (C < 30pF) Q ≥ 350 (C ≥ 30 pF)		
Char.	Specifications										
B, E	D.F. $\leq 5.0\%$										
F	D.F. $\leq 7.5\%$										
SL	Q $\geq 275 + 5/2C^{*1}$ (C < 30pF) Q ≥ 350 (C ≥ 30 pF)										
I.R.	3000M Ω min.										
9	Soldering Effect (Non-Preheat)	<p>As shown in the figure, the lead wires should be immersed in solder of 350\pm10$^{\circ}$C or 260\pm5$^{\circ}$C up to 1.5 to 2.0mm from the root of terminal for 3.5\pm0.5 sec. (10\pm1 sec. for 260\pm5$^{\circ}$C).</p>  <p>Pre-treatment: Capacitor should be stored at 85\pm2$^{\circ}$C for 1 hr., then placed at room condition^{*2} for 24\pm2 hrs. before initial measurements. Post-treatment: Capacitor should be stored for 1 to 2 hrs. at room condition.^{*2}</p>									
		<p>First the capacitor should be stored at 120+0/-5$^{\circ}$C for 60+0/-5 sec. Then, as in the figure, the lead wires should be immersed in solder of 260+0/-5$^{\circ}$C up to 1.5 to 2.0mm from the root of terminal for 7.5+0/-1 sec.</p>  <p>Pre-treatment: Capacitor should be stored at 85\pm2$^{\circ}$C for 1 hr., then placed at room condition^{*2} for 24\pm2 hrs. before initial measurements. Post-treatment: Capacitor should be stored for 1 to 2 hrs. at room condition.^{*2}</p>									
		<p>The capacitor should be firmly soldered to the supporting lead wire and vibrated at a frequency range of 10 to 55Hz, 1.5mm in total amplitude, with about a 1-minute rate of vibration change from 10Hz to 55Hz and back to 10Hz. Apply for a total of 6 hrs., 2 hrs. each in 3 mutually perpendicular directions.</p>									
		<p>Set the capacitor for 500\pm12 hrs. at 40\pm2$^{\circ}$C in 90 to 95% relative humidity. Post-treatment: Capacitor should be stored for 1 to 2 hrs. at room condition.^{*2}</p>									
<p>Apply the rated voltage for 500\pm12 hrs. at 40\pm2$^{\circ}$C in 90 to 95% relative humidity. Post-treatment: Capacitor should be stored for 1 to 2 hrs. at room condition.^{*2}</p>											

*1 "C" expresses nominal capacitance value (pF).

*2 "Room condition" Temperature: 15 to 35 $^{\circ}$ C, Relative humidity: 45 to 75%, Atmospheric pressure: 86 to 106kPa

Continued on the following page. ↗

Type KY/KX Specifications and Test Methods

Continued from the preceding page. ↘

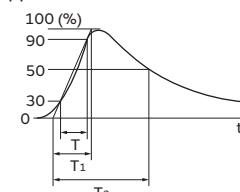
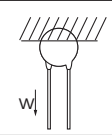
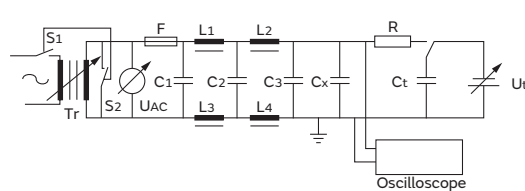
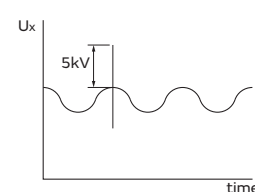
No.	Item	Specifications	Test Method
14	Life	<p>Appearance No marked defect</p> <p>Capacitance Change Within $\pm 20\%$</p> <p>I.R. 3000MΩ min.</p>	<p>Impulse Voltage Each individual capacitor should be subjected to a 5kV (Type KX: 8kV) impulses for three times. Then the capacitors are applied to life test.</p>  <p style="text-align: right;">Front time (T_1) = $1.2\mu s = 1.67T$ Time to half-value (T_2) = $50\mu s$</p> <p>Apply a voltage from Table 4 for 1000 hrs. at $125 \pm 2 / -0^\circ C$, and relative humidity of 50% max.</p> <p style="text-align: center;"><Table 4> Applied Voltage 170% of Rated Voltage except that once each hour the voltage is increased to AC1000V(r.m.s.) for 0.1 sec.</p> <p>Post-treatment: Capacitor should be stored for 1 to 2 hrs. at room condition.*2</p>
	Dielectric Strength	Per Item 6	
15	Robustness of Terminations	<p>Tensile Lead wire should not be cut off. Capacitor should not be broken.</p> <p>Bending</p>	<p>As shown in the figure at right, fix the body of the capacitor and apply a tensile weight gradually to each lead wire in the radial direction of the capacitor up to 10N and keep it for 10 ± 1 sec.</p>  <p>Each lead wire should be subjected to 5N of weight and bent 90° at the point of egress, in one direction, then returned to its original position and bent 90° in the opposite direction at the rate of one bend in 2 to 3 sec.</p>
	Active Flammability	The cheesecloth should not be on fire.	
16	Active Flammability	The cheesecloth should not be on fire.	<p>The capacitor should be individually wrapped in at least one but not more than two complete layers of cheesecloth. The capacitor should be subjected to 20 discharges. The interval between successive discharges should be 5 sec. The UAC should be maintained for 2 min. after the last discharge.</p>  <p> $C_{1,2}$: $1\mu F \pm 10\%$ C_3 : $0.033\mu F \pm 5\%$ 10kV L_1 to 4 : $1.5mH \pm 20\%$ 16A Rod core choke C_t : $3\mu F \pm 5\%$ 10kV R : $100\Omega \pm 2\%$ C_x : Capacitor under test UAC : $U_R \pm 5\%$ F : Fuse, Rated 10A U_R : Rated Voltage U_t : Voltage applied to C_t </p> 

*2 "Room condition" Temperature: 15 to $35^\circ C$, Relative humidity: 45 to 75%, Atmospheric pressure: 86 to 106kPa

Continued on the following page. ↗

Type KY/KX Specifications and Test Methods

Continued from the preceding page. ↘

No.	Item	Specifications	Test Method																																											
17	Passive Flammability	The burning time should not exceed 30 sec. The tissue paper should not ignite.	<p>The capacitor under test should be held in the flame in the position that best promotes burning. Each specimen should only be exposed once to the flame. Time of exposure to flame: 30 sec.</p> <p>Length of flame: 12±1mm Gas burner : Length 35mm min. Inside Dia. 0.5±0.1mm Outside Dia. 0.9mm max. Gas : Butane gas Purity 95% min.</p> 																																											
18	Temperature and Immersion Cycle	<p>Appearance No marked defect</p> <p>Capacitance Change</p> <table border="1"> <thead> <tr> <th>Char.</th> <th>Capacitance Change</th> </tr> </thead> <tbody> <tr> <td>B</td> <td>Within ±10%</td> </tr> <tr> <td>E, F</td> <td>Within ±20%</td> </tr> <tr> <td>SL</td> <td>Within ± 5%</td> </tr> </tbody> </table> <p>D.F. Q</p> <table border="1"> <thead> <tr> <th>Char.</th> <th>Specifications</th> </tr> </thead> <tbody> <tr> <td>B, E</td> <td>D.F. ≤5.0%</td> </tr> <tr> <td>F</td> <td>D.F. ≤7.5%</td> </tr> <tr> <td>SL</td> <td>Q ≥ 275 + 5/2C*¹ (C < 30pF) Q ≥ 350 (C ≥ 30pF)</td> </tr> </tbody> </table> <p>I.R. 3000MΩ min.</p> <p>Dielectric Strength Per Item 6</p>	Char.	Capacitance Change	B	Within ±10%	E, F	Within ±20%	SL	Within ± 5%	Char.	Specifications	B, E	D.F. ≤5.0%	F	D.F. ≤7.5%	SL	Q ≥ 275 + 5/2C* ¹ (C < 30pF) Q ≥ 350 (C ≥ 30pF)	<p>The capacitor should be subjected to 5 temperature cycles, then consecutively to 2 immersion cycles.</p> <p><Temperature Cycle></p> <table border="1"> <thead> <tr> <th>Step</th> <th>Temperature (°C)</th> <th>Time (min)</th> </tr> </thead> <tbody> <tr> <td>1</td> <td>-40+0/-3</td> <td>30</td> </tr> <tr> <td>2</td> <td>Room temp.</td> <td>3</td> </tr> <tr> <td>3</td> <td>125+3/-0</td> <td>30</td> </tr> <tr> <td>4</td> <td>Room temp.</td> <td>3</td> </tr> </tbody> </table> <p>Cycle time: 5 cycles</p> <p><Immersion Cycle></p> <table border="1"> <thead> <tr> <th>Step</th> <th>Temperature (°C)</th> <th>Time (min)</th> <th>Immersion Water</th> </tr> </thead> <tbody> <tr> <td>1</td> <td>65+5/-0</td> <td>15</td> <td>Clean water</td> </tr> <tr> <td>2</td> <td>0±3</td> <td>15</td> <td>Salt water</td> </tr> </tbody> </table> <p>Cycle time: 2 cycles</p> <p>Pre-treatment: Capacitor should be stored at 85±2°C for 1 hr., then placed at room condition*² for 24±2 hrs.</p> <p>Post-treatment: Capacitor should be stored for 24±2 hrs. at room condition.*²</p>	Step	Temperature (°C)	Time (min)	1	-40+0/-3	30	2	Room temp.	3	3	125+3/-0	30	4	Room temp.	3	Step	Temperature (°C)	Time (min)	Immersion Water	1	65+5/-0	15	Clean water	2	0±3	15	Salt water
Char.	Capacitance Change																																													
B	Within ±10%																																													
E, F	Within ±20%																																													
SL	Within ± 5%																																													
Char.	Specifications																																													
B, E	D.F. ≤5.0%																																													
F	D.F. ≤7.5%																																													
SL	Q ≥ 275 + 5/2C* ¹ (C < 30pF) Q ≥ 350 (C ≥ 30pF)																																													
Step	Temperature (°C)	Time (min)																																												
1	-40+0/-3	30																																												
2	Room temp.	3																																												
3	125+3/-0	30																																												
4	Room temp.	3																																												
Step	Temperature (°C)	Time (min)	Immersion Water																																											
1	65+5/-0	15	Clean water																																											
2	0±3	15	Salt water																																											

*¹ "C" expresses nominal capacitance value (pF).

*² "Room condition" Temperature: 15 to 35°C, Relative humidity: 45 to 75%, Atmospheric pressure: 86 to 106kPa

AC250V Ceramic Capacitor Non Safety Certified Type

DEJ Series (Based on the Electrical Appliance and Material Safety Law of Japan)

Features

- This type is based on the electrical appliance and material safety law of Japan (separated table 4).
- Coated with flame-retardant epoxy resin (conforming to UL94V-0 standard).
 Please contact us when a halogen-free product* is necessary.
 * Cl=900ppm max., Br=900ppm max. and Cl+Br=1500ppm max.
- Taping available for automatic insertion.

Applications

Ideal for use on AC line filters and primary-secondary coupling for switching power supplies and AC adapters.

Do not use these products in any automotive power train or safety equipment including battery chargers for electric vehicles and plug-in hybrids. Only Murata products clearly stipulated as "for Automotive use" on its catalog can be used for automobile applications such as power train and safety equipment.

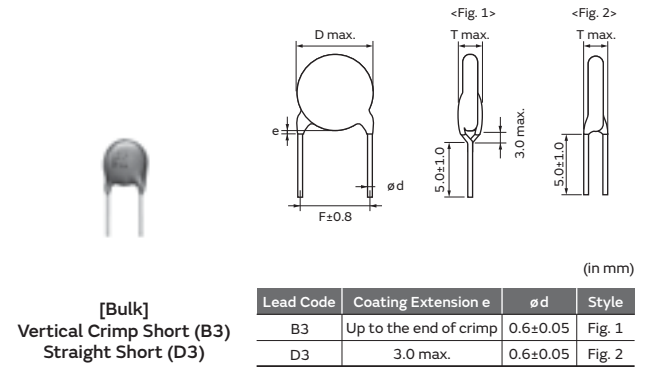
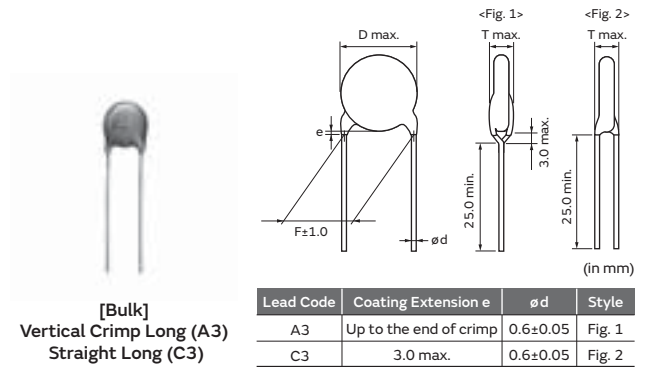

Marking

Temp. Char.		E, F
Nominal Body Diameter	ø7-8mm	102Z 250- 16
	ø9-11mm	332Z 250- C16
Nominal Capacitance		Marked with 3 figures
Capacitance Tolerance		Marked with code
Rated Voltage		Marked with code
Manufacturer's Identification		Marked with (omitted for nominal body diameter ø8mm and under)
Manufactured Date Code		Abbreviation

Part Number	AC Rated Voltage	Temp. Char.	Capacitance	Body Dia. D	Lead Spacing F (mm)	Body Thickness T	Lead Package Long Bulk	Lead Package Short Bulk	Lead Package Taping (1)	Lead Package Taping (2)
DEJE3E2102Z□□□	250Vac(r.m.s.)	E	1000pF+80/-20%	7.0mm max.	7.5	4.0mm max.	C3B	D3B	N2A	P3A
DEJE3E2222Z□□□	250Vac(r.m.s.)	E	2200pF+80/-20%	8.0mm max.	7.5	4.0mm max.	A3B	B3B	N2A	N3A
DEJE3E2332Z□□□	250Vac(r.m.s.)	E	3300pF+80/-20%	9.0mm max.	7.5	4.0mm max.	A3B	B3B	N2A	N3A
DEJE3E2472Z□□□	250Vac(r.m.s.)	E	4700pF+80/-20%	11.0mm max.	7.5	4.0mm max.	A3B	B3B	N2A	N3A
DEJF3E2472Z□□□	250Vac(r.m.s.)	F	4700pF+80/-20%	8.0mm max.	7.5	4.0mm max.	A3B	B3B	N2A	N3A
DEJF3E2103Z□□□	250Vac(r.m.s.)	F	10000pF+80/-20%	11.0mm max.	7.5	4.0mm max.	A3B	B3B	N2A	N3A

Three blank columns are filled with the lead and packaging codes. Please refer to the 3 columns on the right for the appropriate code.
 Taping (1): Lead spacing F=5.0mm, Taping (2): Lead spacing F=7.5mm.

DEJ Series Specifications and Test Methods

Operating Temperature Range: -25 to +85°C

No.	Item	Specifications	Test Method																		
1	Appearance and Dimensions	No visible defect, and dimensions are within specified range.	The capacitor should be visually inspected for evidence of defect. Dimensions should be measured with slide calipers.																		
2	Marking	To be easily legible	The capacitor should be visually inspected.																		
3	Capacitance	Within specified tolerance	The capacitance should be measured at 20°C with 1±0.1kHz and AC5V(r.m.s.) max.																		
4	Dissipation Factor (D.F.)	<table border="1"> <thead> <tr> <th>Char.</th> <th>Specifications</th> </tr> </thead> <tbody> <tr> <td>E</td> <td>D.F. ≤2.5%</td> </tr> <tr> <td>F</td> <td>D.F. ≤5.0%</td> </tr> </tbody> </table>	Char.	Specifications	E	D.F. ≤2.5%	F	D.F. ≤5.0%	The dissipation factor should be measured at 20°C with 1±0.1kHz and AC5V(r.m.s.) max.												
Char.	Specifications																				
E	D.F. ≤2.5%																				
F	D.F. ≤5.0%																				
5	Insulation Resistance (I.R.)	10000MΩ min.	The insulation resistance should be measured with DC500±50V within 60±5 sec. of charging.																		
6	Between Lead Wires	No failure	The capacitor should not be damaged when AC1500V(r.m.s.) are applied between the lead wires for 60 sec.																		
	Body Insulation	No failure	<p>First, the terminals of the capacitor should be connected together. Then, as shown in the figure at right, the capacitor should be immersed into 10% salt solution up to a position of about 3 to 4mm apart from the terminals.</p>  <p>Finally, AC1500V(r.m.s.) is applied for 60 sec. between the capacitor lead wires and electrode plate.</p>																		
7	Temperature Characteristics	<table border="1"> <thead> <tr> <th>Char.</th> <th>Capacitance Change</th> </tr> </thead> <tbody> <tr> <td>E</td> <td>Within $\begin{matrix} +20\% \\ -55\% \end{matrix}$</td> </tr> <tr> <td>F</td> <td>Within $\begin{matrix} +30\% \\ -80\% \end{matrix}$</td> </tr> </tbody> </table>	Char.	Capacitance Change	E	Within $\begin{matrix} +20\% \\ -55\% \end{matrix}$	F	Within $\begin{matrix} +30\% \\ -80\% \end{matrix}$	<p>The capacitance measurement should be made at each step specified in Table 1.</p> <p style="text-align: center;"><Table 1></p> <table border="1"> <thead> <tr> <th>Step</th> <th>Temperature (°C)</th> </tr> </thead> <tbody> <tr> <td>1</td> <td>20±2</td> </tr> <tr> <td>2</td> <td>-25±2</td> </tr> <tr> <td>3</td> <td>20±2</td> </tr> <tr> <td>4</td> <td>85±2</td> </tr> <tr> <td>5</td> <td>20±2</td> </tr> </tbody> </table>	Step	Temperature (°C)	1	20±2	2	-25±2	3	20±2	4	85±2	5	20±2
Char.	Capacitance Change																				
E	Within $\begin{matrix} +20\% \\ -55\% \end{matrix}$																				
F	Within $\begin{matrix} +30\% \\ -80\% \end{matrix}$																				
Step	Temperature (°C)																				
1	20±2																				
2	-25±2																				
3	20±2																				
4	85±2																				
5	20±2																				
8	Appearance	No marked defect	<p>As in Figure 1, discharge is made 50 times at 5 sec. intervals from the capacitor (Cd) charged at DC voltage of specified.</p>  <p style="text-align: center;">Fig.1</p> <p>Ct: Capacitor under test R2: 100MΩ S: High-voltage switch R3: Surge resistance R1: 1000Ω</p> <table border="1"> <tbody> <tr> <td>Cd</td> <td>0.001μF</td> </tr> <tr> <td>Vs</td> <td>DC10kV</td> </tr> </tbody> </table>	Cd	0.001μF	Vs	DC10kV														
	Cd	0.001μF																			
Vs	DC10kV																				
Dielectric Strength	Per Item 6																				
9	Solderability of Leads	Lead wire should be soldered with uniform coating on the axial direction over 3/4 of the circumferential direction.	<p>The lead wire of a capacitor should be dipped into molten solder for 2±0.5 sec. The depth of immersion is up to about 1.5 to 2.0mm from the root of lead wires. Temp. of solder: Lead Free Solder (Sn-3Ag-0.5Cu) 245±5°C H63 Eutectic Solder 235±5°C</p>																		

Continued on the following page. ↗

DEJ Series Specifications and Test Methods

Continued from the preceding page. ↘

No.	Item	Specifications	Test Method						
10	Appearance	No marked defect	As shown in the figure, the lead wires should be immersed in solder of $350 \pm 10^\circ\text{C}$ up to 1.5 to 2.0mm from the root of terminal for 3.5 ± 0.5 sec. Pre-treatment: Capacitor should be stored at $85 \pm 2^\circ\text{C}$ for 1 hr., then placed at room condition* ¹ for 24±2 hrs. before initial measurements. Post-treatment: Capacitor should be stored for 4 to 24 hrs. at room condition.* ¹						
	I.R.	1000MΩ min.							
	Dielectric Strength	Per Item 6							
11	Appearance	No marked defect	First the capacitor should be stored at $120 + 0 / - 5^\circ\text{C}$ for $60 + 0 / - 5$ sec. Then, as in the figure, the lead wires should be immersed in solder of $260 + 0 / - 5^\circ\text{C}$ up to 1.5 to 2.0mm from the root of terminal for $7.5 + 0 / - 1$ sec. Pre-treatment: Capacitor should be stored at $85 \pm 2^\circ\text{C}$ for 1 hr., then placed at room condition* ¹ for 24±2 hrs. before initial measurements. Post-treatment: Capacitor should be stored for 4 to 24 hrs. at room condition.* ¹						
	I.R.	1000MΩ min.							
	Dielectric Strength	Per Item 6							
12	Appearance	No marked defect	The capacitor should be firmly soldered to the supporting lead wire and vibrated at a frequency range of 10 to 55Hz, 1.5mm in total amplitude, with about a 1-minute rate of vibration change from 10Hz to 55Hz and back to 10Hz. Apply for a total of 6 hrs., 2 hrs. each in 3 mutually perpendicular directions.						
	Capacitance	Within the specified tolerance							
	D.F.	<table border="1" style="width: 100%; border-collapse: collapse;"> <thead> <tr> <th style="width: 50%;">Char.</th> <th style="width: 50%;">Specifications</th> </tr> </thead> <tbody> <tr> <td>E</td> <td>D.F. ≤ 2.5%</td> </tr> <tr> <td>F</td> <td>D.F. ≤ 5.0%</td> </tr> </tbody> </table>		Char.	Specifications	E	D.F. ≤ 2.5%	F	D.F. ≤ 5.0%
Char.	Specifications								
E	D.F. ≤ 2.5%								
F	D.F. ≤ 5.0%								
13	Appearance	No marked defect	The capacitor should be immersed into a isopropyl alcohol for 30 ± 5 sec.						
14	Appearance	No marked defect	Set the capacitor for 500 ± 12 hrs. at $40 \pm 2^\circ\text{C}$ in 90 to 95% relative humidity. Pre-treatment: Capacitor should be stored at $85 \pm 2^\circ\text{C}$ for 1 hr., then placed at room condition* ¹ for 24±2 hrs. before initial measurements. Post-treatment: Capacitor should be stored for 1 to 2 hrs. at room condition.* ¹						
	Capacitance Change	<table border="1" style="width: 100%; border-collapse: collapse;"> <thead> <tr> <th style="width: 50%;">Char.</th> <th style="width: 50%;">Capacitance Change</th> </tr> </thead> <tbody> <tr> <td>E</td> <td>Within ±20%</td> </tr> <tr> <td>F</td> <td>Within ±30%</td> </tr> </tbody> </table>		Char.	Capacitance Change	E	Within ±20%	F	Within ±30%
	Char.	Capacitance Change							
	E	Within ±20%							
	F	Within ±30%							
D.F.	<table border="1" style="width: 100%; border-collapse: collapse;"> <thead> <tr> <th style="width: 50%;">Char.</th> <th style="width: 50%;">Specifications</th> </tr> </thead> <tbody> <tr> <td>E</td> <td>D.F. ≤ 5.0%</td> </tr> <tr> <td>F</td> <td>D.F. ≤ 7.5%</td> </tr> </tbody> </table>	Char.	Specifications	E	D.F. ≤ 5.0%	F	D.F. ≤ 7.5%		
Char.	Specifications								
E	D.F. ≤ 5.0%								
F	D.F. ≤ 7.5%								
I.R.	1000MΩ min.								
Dielectric Strength	Per Item 6								
15	Appearance	No marked defect	The capacitor should be subjected to $40 \pm 2^\circ\text{C}$, relative humidity of 90 to 98% for 8 hrs., and then removed in room temperature for 16 hrs. until 5 cycles are completed. Pre-treatment: Capacitor should be stored at $85 \pm 2^\circ\text{C}$ for 1 hr., then placed at room condition* ¹ for 24±2 hrs. before initial measurements. Post-treatment: Capacitor should be stored for 1 to 2 hrs. at room condition.* ¹						
	Capacitance Change	<table border="1" style="width: 100%; border-collapse: collapse;"> <thead> <tr> <th style="width: 50%;">Char.</th> <th style="width: 50%;">Capacitance Change</th> </tr> </thead> <tbody> <tr> <td>E</td> <td>Within ±20%</td> </tr> <tr> <td>F</td> <td>Within ±30%</td> </tr> </tbody> </table>		Char.	Capacitance Change	E	Within ±20%	F	Within ±30%
	Char.	Capacitance Change							
	E	Within ±20%							
	F	Within ±30%							
D.F.	<table border="1" style="width: 100%; border-collapse: collapse;"> <thead> <tr> <th style="width: 50%;">Char.</th> <th style="width: 50%;">Specifications</th> </tr> </thead> <tbody> <tr> <td>E</td> <td>D.F. ≤ 5.0%</td> </tr> <tr> <td>F</td> <td>D.F. ≤ 7.5%</td> </tr> </tbody> </table>	Char.	Specifications	E	D.F. ≤ 5.0%	F	D.F. ≤ 7.5%		
Char.	Specifications								
E	D.F. ≤ 5.0%								
F	D.F. ≤ 7.5%								
I.R.	1000MΩ min.								
Dielectric Strength	Per Item 6								

*¹ "Room condition" Temperature: 15 to 35°C, Relative humidity: 45 to 75%, Atmospheric pressure: 86 to 106kPa

Continued on the following page. ↗

DEJ Series Specifications and Test Methods

Continued from the preceding page. ↘

No.	Item	Specifications	Test Method																												
16	Humidity Loading	Appearance	No marked defect																												
	Capacitance Change	<table border="1"> <thead> <tr> <th>Char.</th> <th>Capacitance Change</th> </tr> </thead> <tbody> <tr> <td>E</td> <td>Within ±20%</td> </tr> <tr> <td>F</td> <td>Within ±30%</td> </tr> </tbody> </table>	Char.	Capacitance Change	E	Within ±20%	F	Within ±30%	Apply the rated voltage for 500±12 hrs. at 40±2°C in 90 to 95% relative humidity. Pre-treatment: Capacitor should be stored at 85±2°C for 1 hr., then placed at room condition*1 for 24±2 hrs. before initial measurements. Post-treatment: Capacitor should be stored for 1 to 2 hrs. at room condition.*1																						
	Char.	Capacitance Change																													
	E	Within ±20%																													
	F	Within ±30%																													
D.F.	<table border="1"> <thead> <tr> <th>Char.</th> <th>Specifications</th> </tr> </thead> <tbody> <tr> <td>E</td> <td>D.F. ≤5.0%</td> </tr> <tr> <td>F</td> <td>D.F. ≤7.5%</td> </tr> </tbody> </table>	Char.	Specifications	E	D.F. ≤5.0%	F	D.F. ≤7.5%																								
Char.	Specifications																														
E	D.F. ≤5.0%																														
F	D.F. ≤7.5%																														
I.R.	1000MΩ min.																														
Dielectric Strength	Per Item 6																														
17	Life	Appearance	No marked defect																												
	Capacitance Change	<table border="1"> <thead> <tr> <th>Char.</th> <th>Capacitance Change</th> </tr> </thead> <tbody> <tr> <td>E</td> <td>Within ±20%</td> </tr> <tr> <td>F</td> <td>Within ±30%</td> </tr> </tbody> </table>	Char.	Capacitance Change	E	Within ±20%	F	Within ±30%	Apply a voltage from Table 2 for 1500 hrs. at 85±2°C, relative humidity 50% max. <Table 2> <table border="1"> <thead> <tr> <th>Applied Voltage</th> </tr> </thead> <tbody> <tr> <td>AC500V(r.m.s.), except that once each hour the voltage is increased to AC1000V(r.m.s.) for 0.1 sec.</td> </tr> </tbody> </table> Pre-treatment: Capacitor should be stored at 85±2°C for 1 hr., then placed at room condition*1 for 24±2 hrs. before initial measurements. Post-treatment: Capacitor should be stored for 4 to 24 hrs. at room condition.*1	Applied Voltage	AC500V(r.m.s.), except that once each hour the voltage is increased to AC1000V(r.m.s.) for 0.1 sec.																				
	Char.	Capacitance Change																													
	E	Within ±20%																													
F	Within ±30%																														
Applied Voltage																															
AC500V(r.m.s.), except that once each hour the voltage is increased to AC1000V(r.m.s.) for 0.1 sec.																															
I.R.	1000MΩ min.																														
Dielectric Strength	Per Item 6																														
18	Flame Test	The capacitor flame discontinued as follows. <table border="1"> <thead> <tr> <th>Cycle</th> <th>Time (sec.)</th> </tr> </thead> <tbody> <tr> <td>1 to 2</td> <td>15 max.</td> </tr> <tr> <td>3</td> <td>60 max.</td> </tr> </tbody> </table>	Cycle	Time (sec.)	1 to 2	15 max.	3	60 max.	The capacitor should be subjected to applied flame for 15 sec. and then removed for 15 sec. until 3 cycles are completed. 																						
	Cycle	Time (sec.)																													
1 to 2	15 max.																														
3	60 max.																														
19	Robustness of Terminations	Tensile Lead wire should not be cut off. Capacitor should not be broken.																													
20	Temperature and Immersion Cycle	Bending Each lead wire should be subjected to 5N of weight and bent 90° at the point of egress, in one direction, then returned to its original position and bent 90° in the opposite direction at the rate of one bend in 2 to 3 sec.																													
		Appearance	No marked defect	The capacitor should be subjected to 5 temperature cycles, then consecutively to 2 immersion cycles. <Temperature Cycle> <table border="1"> <thead> <tr> <th>Step</th> <th>Temperature (°C)</th> <th>Time (min)</th> </tr> </thead> <tbody> <tr> <td>1</td> <td>-25+0/-3</td> <td>30</td> </tr> <tr> <td>2</td> <td>Room temp.</td> <td>3</td> </tr> <tr> <td>3</td> <td>85+3/-0</td> <td>30</td> </tr> <tr> <td>4</td> <td>Room temp.</td> <td>3</td> </tr> </tbody> </table> Cycle time: 5 cycles <Immersion Cycle> <table border="1"> <thead> <tr> <th>Step</th> <th>Temperature (°C)</th> <th>Time (min)</th> <th>Immersion Water</th> </tr> </thead> <tbody> <tr> <td>1</td> <td>65+5/-0</td> <td>15</td> <td>Clean water</td> </tr> <tr> <td>2</td> <td>0±3</td> <td>15</td> <td>Salt water</td> </tr> </tbody> </table> Cycle time: 2 cycles Pre-treatment: Capacitor should be stored at 85±2°C for 1 hr., then placed at room condition*1 for 24±2 hrs. Post-treatment: Capacitor should be stored for 4 to 24 hrs. at room condition.*1	Step	Temperature (°C)	Time (min)	1	-25+0/-3	30	2	Room temp.	3	3	85+3/-0	30	4	Room temp.	3	Step	Temperature (°C)	Time (min)	Immersion Water	1	65+5/-0	15	Clean water	2	0±3	15	Salt water
		Step	Temperature (°C)		Time (min)																										
		1	-25+0/-3		30																										
		2	Room temp.		3																										
3	85+3/-0	30																													
4	Room temp.	3																													
Step	Temperature (°C)	Time (min)	Immersion Water																												
1	65+5/-0	15	Clean water																												
2	0±3	15	Salt water																												
Capacitance Change	<table border="1"> <thead> <tr> <th>Char.</th> <th>Capacitance Change</th> </tr> </thead> <tbody> <tr> <td>E</td> <td>Within ±20%</td> </tr> <tr> <td>F</td> <td>Within ±30%</td> </tr> </tbody> </table>	Char.	Capacitance Change	E	Within ±20%	F	Within ±30%																								
Char.	Capacitance Change																														
E	Within ±20%																														
F	Within ±30%																														
D.F.	<table border="1"> <thead> <tr> <th>Char.</th> <th>Specifications</th> </tr> </thead> <tbody> <tr> <td>E</td> <td>D.F. ≤5.0%</td> </tr> <tr> <td>F</td> <td>D.F. ≤7.5%</td> </tr> </tbody> </table>	Char.	Specifications	E	D.F. ≤5.0%	F	D.F. ≤7.5%																								
Char.	Specifications																														
E	D.F. ≤5.0%																														
F	D.F. ≤7.5%																														
I.R.	1000MΩ min.																														
Dielectric Strength	Per Item 6																														

*1 "Room condition" Temperature: 15 to 35°C, Relative humidity: 45 to 75%, Atmospheric pressure: 86 to 106kPa

Safety Certified Ceramic Capacitors Characteristics Data (Typical Example)

Capacitance - Temperature Characteristics



Insertion Loss - Frequency Characteristics

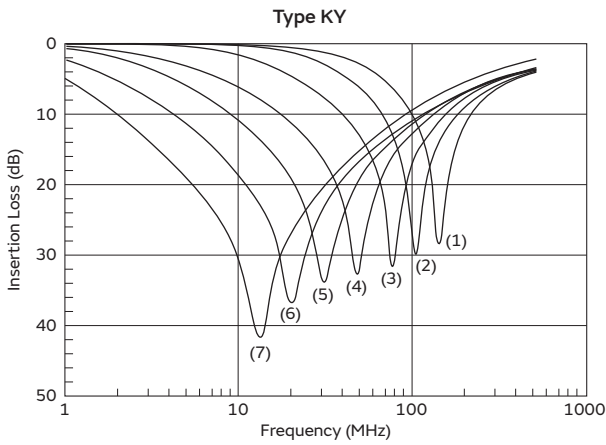

- Type KY
 Signal power: 1mW
 AC240V(r.m.s.) / 60Hz is applied on the capacitor.
- (1) DE2B3KY101KA2B****
 - (2) DE2B3KY221KA2B****
 - (3) DE2B3KY471KA2B****
 - (4) DE2E3KY102MA2B****
 - (5) DE2E3KY222MA2B****
 - (6) DE2E3KY472MA2B****
 - (7) DE2F3KY103MA3B****

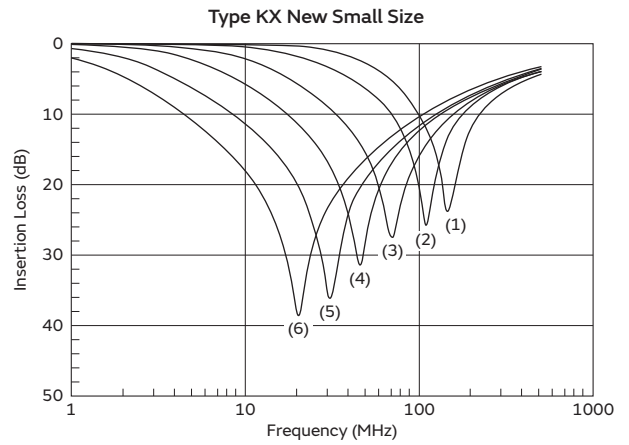

- Type KX New Small Size
 Signal power: 1mW
 AC240V(r.m.s.) / 60Hz is applied on the capacitor.
- (1) DE1B3KX101KA4BN01F
 - (2) DE1B3KX221KA4BN01F
 - (3) DE1B3KX471KA4BN01F
 - (4) DE1E3KX102MA4BN01F
 - (5) DE1E3KX222MA4BN01F
 - (6) DE1E3KX472MA4BN01F

Safety Certified Ceramic Capacitors Characteristics Data (Typical Example)

Leakage Current Characteristics

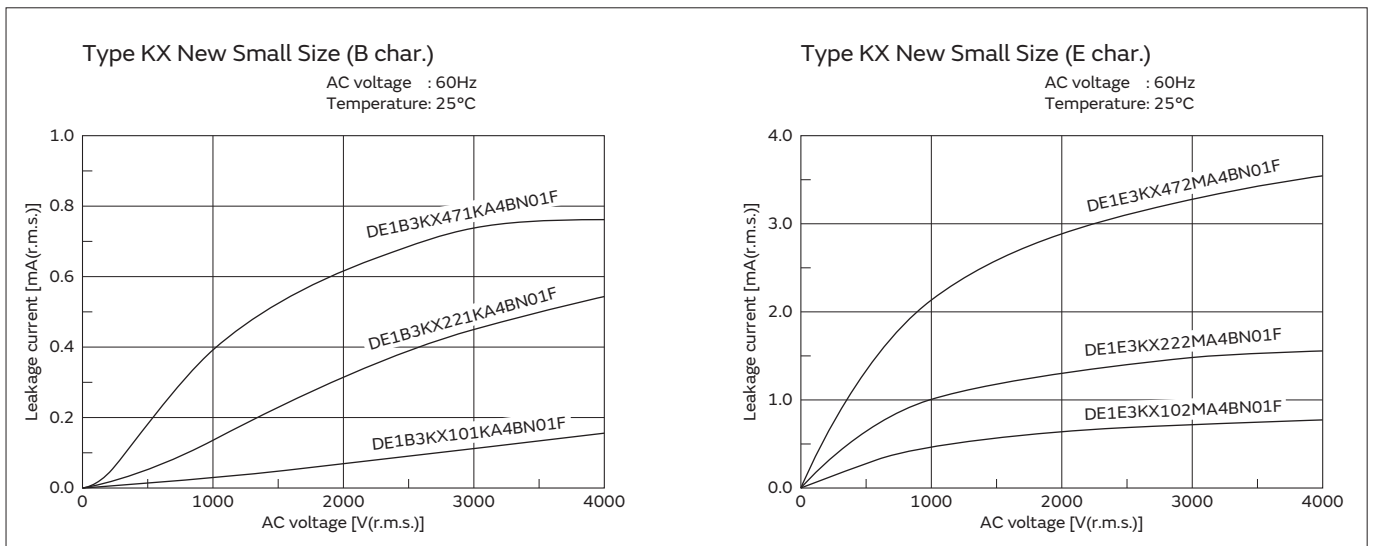
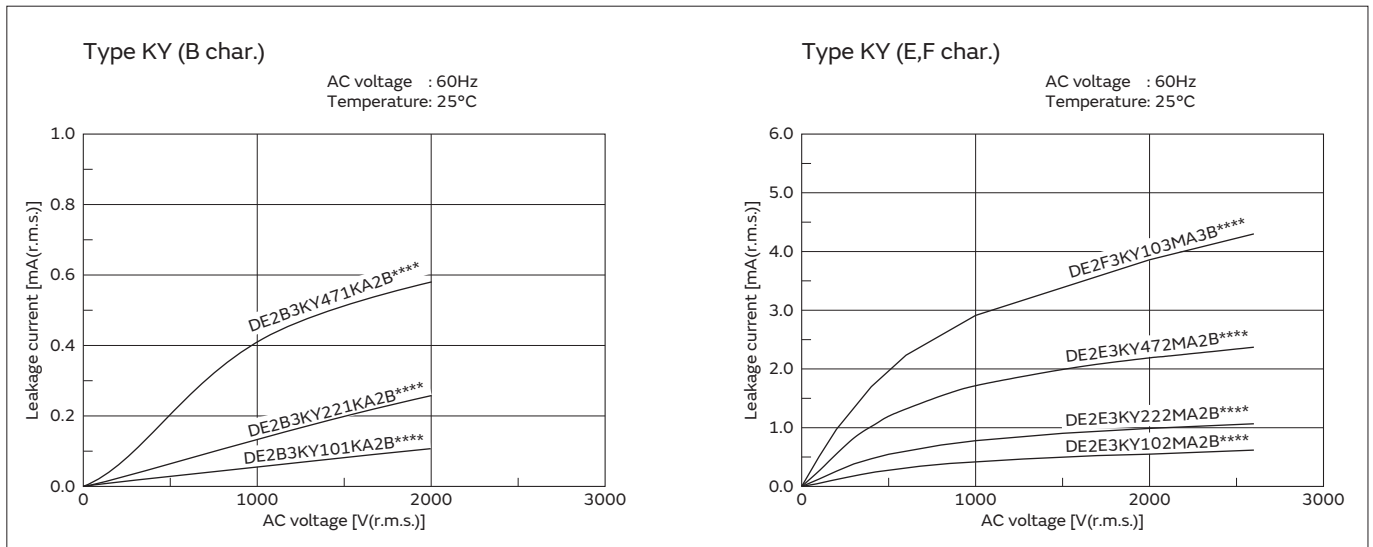

Safety Certified Ceramic Capacitors Packaging

Taping Specifications

- 12.7mm pitch / lead spacing 5mm taping
 Vertical crimp type
 (Lead Code: N2)



- 15mm pitch / lead spacing 7.5mm taping
 Vertical crimp type
 (Lead Code: N3)

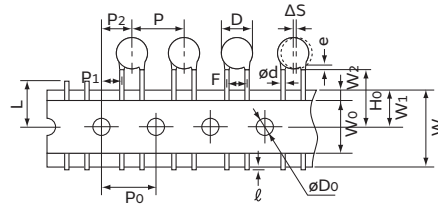

- 15mm pitch / lead spacing 7.5mm taping
 Straight type
 (Lead Code: P3)

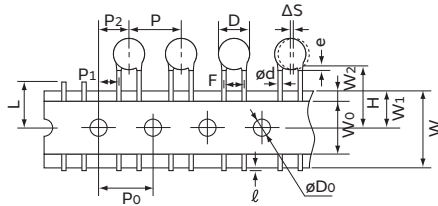

- 30mm pitch / lead spacing 7.5mm taping
 Vertical crimp type
 (Lead Code: N7)

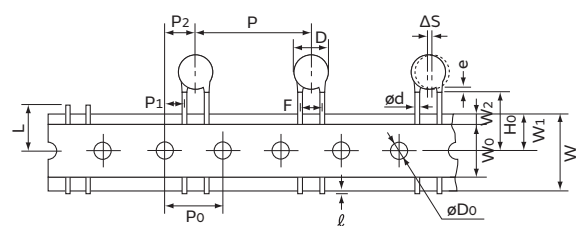

- 25.4mm pitch / lead spacing 10.0mm taping
 Vertical crimp type
 (Lead Code: N4, N5)

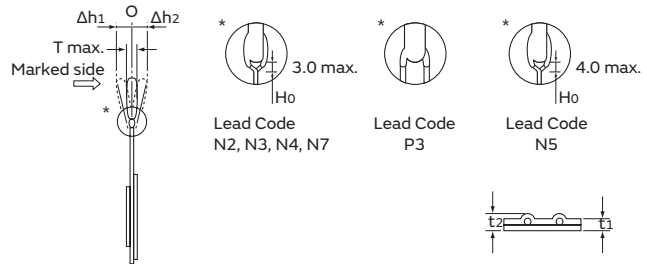

Item	Code	N2	N3	P3	N7	N4	N5
Pitch of component	P	12.7±1.0	15.0±2.0	30.0±2.0	25.4±2.0		
Pitch of sprocket hole	P0	12.7±0.3	15.0±0.3	12.7±0.3			
Lead spacing	F	5.0 ^{+0.8} _{-0.2}	7.5±1.0	10.0±1.0			
Length from hole center to component center	P2	6.35±1.3	7.5±1.5				
Length from hole center to lead	P1	3.85±0.7	3.75±1.0	7.7±1.5			
Body diameter	D	See the individual product specifications.					
Deviation along tape, left or right	ΔS	0±1.0	0±2.0				
Carrier tape width	W	18.0±0.5					
Position of sprocket hole	W1	9.0±0.5					
Lead distance between reference and bottom planes	H0	18.0 ^{+2.0} ₀	—	18.0 ^{+2.0} ₀			
	H	—	20.0 ^{+1.5} _{-1.0}	—			
Protrusion length	ℓ	+0.5 to -1.0					
Diameter of sprocket hole	øDo	4.0±0.1					
Lead diameter	ød	0.6±0.05					0.6 ^{+0.1} _{-0.05}
Total tape thickness	t1	0.6±0.3					
Total thickness, tape and lead wire	t2	1.5 max.					
Body thickness	T	See the individual product specifications.					
Portion to cut in case of defect	L	11.0 ⁰ _{-1.0}					
Hold down tape width	W0	11.5 min.					
Hold down tape position	W2	1.5±1.5					
Coating extension on lead	e	Up to the end of crimp	3.0 max.	Up to the end of crimp			
Deviation across tape, front	Δh1	1.0 max.	2.0 max.				
Deviation across tape, rear	Δh2	2.0 max.					



(in mm)

Continued on the following page. ↗

Safety Certified Ceramic Capacitors Packaging

Continued from the preceding page. ↘

Packaging Styles

Bulk	Taping
Polyethylene Bag 	Ammo Pack 

Minimum Quantity (Order in Sets Only)

[Bulk] (pcs./Bag)

	Body Dia. D (mm)	Lead Code A□, C□	Lead Code B□, D□
		Long	Short
Type KY	7	250 *	500
Type KX (New Small Size)	8 to 11	250	500
DEJ Series	12 to 14	200	250
	15, 16	100	200

* Lead Spacing F=5.0mm (Code: A2): 500pcs.

[Taping] (pcs./Ammo Pack)

Lead Code	N2	N3, P3	N4, N5, N7
Type KY	1,000	900	-
Type KX (New Small Size)	-	-	500
DEJ Series	1,500	1,000	-

Safety Certified Ceramic Capacitors ⚠️Caution

⚠️Caution (Rating)

1. Operating Voltage

When DC-rated capacitors are to be used in AC or ripple current circuits, be sure to maintain the V_{p-p} value of the applied voltage or the V_{o-p} that contains DC bias within the rated voltage range.

When the voltage is applied to the circuit, starting or stopping may generate irregular voltage for a transit period because of resonance or switching. Be sure to use a capacitor with a rated voltage range that includes these irregular voltages.

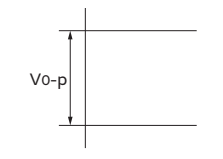
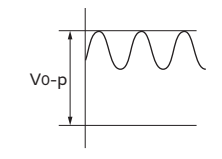
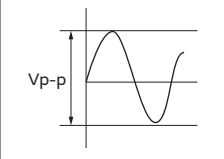
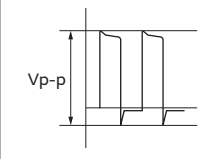
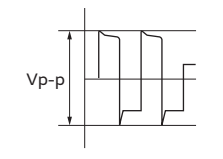
Voltage	DC Voltage	DC+AC Voltage	AC Voltage	Pulse Voltage (1)	Pulse Voltage (2)
Positional Measurement					

2. Operating Temperature and Self-generated Heat (Apply to B/E/F Char.)

Keep the surface temperature of a capacitor below the upper limit of its rated operating temperature range. Be sure to take into account the heat generated by the capacitor itself. When the capacitor is used in a high-frequency current, pulse current or similar current, it may have self-generated heat due to dielectric loss. Applied voltage load should be such that self-generated heat is within 20°C under the condition where the capacitor is subjected to an atmospheric temperature of 25°C. When measuring, use a thermocouple of small thermal capacity-K of $\phi 0.1\text{mm}$ under conditions where the capacitor is not affected by radiant heat from other components or wind from surroundings. Excessive heat may lead to deterioration of the capacitor's characteristics and reliability. (Never attempt to perform measurement with the cooling fan running. Otherwise, accurate measurement cannot be ensured.)

3. Test Condition for Withstanding Voltage

(1) Test Equipment

Test equipment for AC withstanding voltage should be used with the performance of the wave similar to 50/60Hz sine wave.

If the distorted sine wave or overload exceeding the specified voltage value is applied, a defect may be caused.

Continued on the following page. ↗

Safety Certified Ceramic Capacitors ⚠Caution

Continued from the preceding page. ↘

(2) Voltage Applied Method

When the withstanding voltage is applied, the capacitor's lead or terminal should be firmly connected to the output of the withstanding voltage test equipment, and then the voltage should be raised from near zero to the test voltage.

If the test voltage without the raise from near zero voltage would be applied directly to capacitor, test voltage should be applied with the zero cross.* At the end of the test time, the test voltage should be reduced to near zero, and then capacitor's lead or terminal should be taken off the output of the withstanding voltage test equipment.

If the test voltage without the raise from near zero voltage would be applied directly to capacitor, the surge voltage may rise, and therefore, a defect may be caused.

*ZERO CROSS is the point where voltage sine wave passes 0V. See the figure at right.

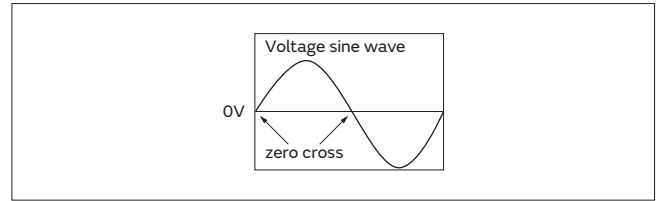

4. Fail-Safe

When the capacitor is broken, failure may result in a short circuit. Be sure to provide an appropriate fail-safe function like a fuse on your product if failure could result in an electric shock, fire or fuming.

FAILURE TO FOLLOW THE ABOVE CAUTIONS MAY RESULT, WORST CASE, IN A SHORT CIRCUIT AND CAUSE FUMING OR PARTIAL DISPERSION WHEN THE PRODUCT IS USED.

Safety Certified Ceramic Capacitors ⚠️Caution

⚠️Caution (Storage and Operating Condition)

Operating and Storage Environment

The insulating coating of capacitors does not form a perfect seal; therefore, do not use or store capacitors in a corrosive atmosphere, especially where chloride gas, sulfide gas, acid, alkali, salt or the like are present. Also, avoid exposure to moisture. Before cleaning, bonding, or molding this product, verify that these processes do not affect product quality by testing the performance of a cleaned, bonded or molded product in the intended equipment. Store the capacitors where the temperature and relative humidity do not exceed -10 to 40 degrees centigrade and 15 to 85%.

Use capacitors within 6 months after delivery.
Check the solderability after 6 months or more.

FAILURE TO FOLLOW THE ABOVE CAUTIONS MAY RESULT, WORST CASE, IN A SHORT CIRCUIT AND CAUSE FUMING OR PARTIAL DISPERSION WHEN THE PRODUCT IS USED.

⚠️Caution (Soldering and Mounting)

1. Vibration and Impact

Do not expose a capacitor or its lead wires to excessive shock or vibration during use. Excessive shock or vibration may cause fatigue destruction of lead wires mounted on the circuit board.
Please take measures to hold a capacitor on the circuit boards by adhesive, molding resin or another coating.
Please confirm there is no influence of holding measures on the product with the intended equipment.

2. Soldering

When soldering this product to a PCB/PWB, do not exceed the solder heat resistance specifications of the capacitor. Subjecting this product to excessive heating could melt the internal junction solder and may result in thermal shocks that can crack the ceramic element.
Soldering the capacitor with a soldering iron should be performed in the following conditions.
Temperature of iron-tip: 400 degrees C. max.
Soldering iron wattage: 50W max.
Soldering time: 3.5 sec. max.

3. Bonding, Resin Molding and Coating

For bonding, molding or coating this product, verify that these processes do not affect the quality of the capacitor by testing the performance of the bonded, molded or coated product in the intended equipment. When the amount of applications, dryness/hardening conditions of adhesives and molding resins containing organic solvents (ethyl acetate, methyl ethyl ketone, toluene, etc). are unsuitable, the outer coating resin of a capacitor is damaged by the organic solvents and it may result, worst case, in a short circuit.
The variation in thickness of adhesive, molding resin or coating may cause outer coating resin cracking and/or ceramic element cracking of a capacitor in a temperature cycling.

4. Treatment after Bonding, Resin Molding and Coating

When the outer coating is hot (over 100 degrees C.) after soldering, it becomes soft and fragile. Therefore, please be careful not to give it mechanical stress.

FAILURE TO FOLLOW THE ABOVE CAUTIONS MAY RESULT, WORST CASE, IN A SHORT CIRCUIT AND CAUSE FUMING OR PARTIAL DISPERSION WHEN THE PRODUCT IS USED.

⚠️Caution (Handling)

Vibration and Impact

Do not expose a capacitor or its lead wires to excessive shock or vibration during use. Excessive shock or vibration may cause fatigue destruction of lead wires mounted on the circuit board.
Please take measures to hold a capacitor on the circuit boards by adhesive, molding resin or another coating.

Please confirm there is no influence of holding measures on the product with the intended equipment.

FAILURE TO FOLLOW THE ABOVE CAUTIONS MAY RESULT, WORST CASE, IN A SHORT CIRCUIT AND CAUSE FUMING OR PARTIAL DISPERSION WHEN THE PRODUCT IS USED.

Safety Certified Ceramic Capacitors Notice

Notice (Soldering and Mounting)

Cleaning (ultrasonic cleaning)

To perform ultrasonic cleaning, observe the following conditions.

Rinse bath capacity: Output of 20 watts per liter or less.

Rinsing time: 5 min. maximum.

Do not vibrate the PCB/PWB directly.

Excessive ultrasonic cleaning may lead to fatigue destruction of the lead wires.

Notice (Rating)

1. Capacitance Change of Capacitors

(1) For SL char.

Capacitance might change a little depending on a surrounding temperature or an applied voltage.

Please contact us if you use a strict constant time circuit.

(2) For B/E/F char.

Capacitors have an aging characteristic, whereby the capacitor continually decreases its capacitance slightly if the capacitor is left on for a long time. Moreover, capacitance might change greatly depending on the surrounding temperature or an applied voltage. Therefore, it is not likely to be suitable for use in a constant time circuit.

Please contact us if you need detailed information.

2. Performance Check by Equipment

Before using a capacitor, check that there is no problem in the equipment's performance and the specifications.

Generally speaking, CLASS 2 (B/E/F char.) ceramic capacitors have voltage dependence characteristics and temperature dependence characteristics in capacitance, so the capacitance value may change depending on the operating condition in the equipment. Therefore, be sure to confirm the apparatus performance of receiving influence in the capacitance value change of a capacitor, such as leakage current and noise suppression characteristic.

Moreover, check the surge-proof ability of a capacitor in the equipment, if needed, because the surge voltage may exceed specific value by the inductance of the circuit.

High Voltage Ceramic Capacitors

DEH Series (125°C Guaranteed/Low-dissipation Factor/DC2kV, 3.15kV)

Features

1. Reduced heat dissipation permitted due to small dielectric loss of the ceramic material.
2. Operating temperature range is guaranteed up to 125 degrees C.
3. Coated with flame-retardant epoxy resin (equivalent to UL94V-0 standard).
 Please contact us when a halogen-free product* is necessary.
 * Cl=900ppm max., Br=900ppm max. and Cl+Br=1500ppm max.
4. Taping available for automatic insertion.

Applications

Ideal for use on high-frequency pulse circuits such as a horizontal resonance circuit for CTV and snubber circuits for switching power supplies.

Do not use these products in any automotive power train or safety equipment including battery chargers for electric vehicles and plug-in hybrids. Only Murata products clearly stipulated as "for Automotive use" on its catalog can be used for automobile applications such as power train and safety equipment.

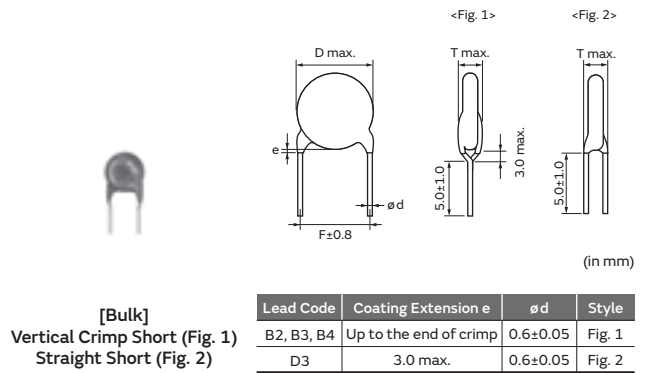
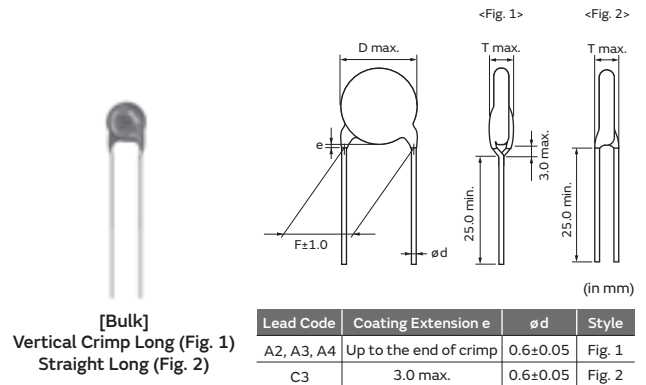

Marking

Rated Voltage	DC2kV, 3.15kV	
Nominal Body Diameter	Temp. Char.	R
ø7-9mm		HR R 102K 2KV 66
ø10-21mm		HR R 272K 3KV M66
High Temperature Guaranteed Code	HR	
Temperature Characteristics	Marked with code (omitted for nominal body diameter ø6mm)	
Nominal Capacitance	Marked with 3 figures	
Capacitance Tolerance	Marked with code (omitted for nominal body diameter ø6mm)	
Rated Voltage	Marked with code (for DC3.15kV, marked with 3KV)	
Manufacturer's Identification	Marked with (omitted for nominal body diameter ø9mm and under)	
Manufactured Date Code	Abbreviation	

DC2-3.15kV, R Characteristics

Part Number	DC Rated Voltage	Capacitance	Body Dia. D	Lead Spacing F (mm)	Body Thickness T	Lead Package Long Bulk	Lead Package Short Bulk	Lead Package Taping
DEHR33D221K□□□	2000Vdc	220pF±10%	7.0mm max.	7.5	5.0mm max.	C3B	D3B	P3A
DEHR33D271K□□□	2000Vdc	270pF±10%	7.0mm max.	7.5	5.0mm max.	C3B	D3B	P3A
DEHR33D331K□□□	2000Vdc	330pF±10%	8.0mm max.	7.5	5.0mm max.	A3B	B3B	N3A
DEHR33D391K□□□	2000Vdc	390pF±10%	8.0mm max.	7.5	5.0mm max.	A3B	B3B	N3A
DEHR33D471K□□□	2000Vdc	470pF±10%	9.0mm max.	7.5	5.0mm max.	A3B	B3B	N3A
DEHR33D561K□□□	2000Vdc	560pF±10%	9.0mm max.	7.5	5.0mm max.	A3B	B3B	N3A
DEHR33D681K□□□	2000Vdc	680pF±10%	10.0mm max.	7.5	5.0mm max.	A3B	B3B	N3A
DEHR33D821K□□□	2000Vdc	820pF±10%	11.0mm max.	7.5	5.0mm max.	A3B	B3B	N3A
DEHR33D102K□□□	2000Vdc	1000pF±10%	12.0mm max.	7.5	5.0mm max.	A3B	B3B	N3A
DEHR33D122K□□□	2000Vdc	1200pF±10%	12.0mm max.	7.5	5.0mm max.	A3B	B3B	N3A
DEHR33D152K□□□	2000Vdc	1500pF±10%	12.0mm max.	7.5	5.0mm max.	A3B	B3B	N3A
DEHR33D182K□□□	2000Vdc	1800pF±10%	14.0mm max.	7.5	5.0mm max.	A3B	B3B	N7A
DEHR33D222K□□□	2000Vdc	2200pF±10%	15.0mm max.	7.5	5.0mm max.	A3B	B3B	N7A
DEHR33D272K□□□	2000Vdc	2700pF±10%	17.0mm max.	7.5	5.0mm max.	A3B	B3B	N7A
DEHR33D332K□□□	2000Vdc	3300pF±10%	19.0mm max.	10.0	5.0mm max.	A4B	B4B	-
DEHR33D392K□□□	2000Vdc	3900pF±10%	20.0mm max.	10.0	5.0mm max.	A4B	B4B	-
DEHR33D472K□□□	2000Vdc	4700pF±10%	21.0mm max.	10.0	5.0mm max.	A4B	B4B	-
DEHR33F151K□□□	3150Vdc	150pF±10%	7.0mm max.	7.5	6.0mm max.	C3B	D3B	P3A
DEHR33F181K□□□	3150Vdc	180pF±10%	7.0mm max.	7.5	6.0mm max.	C3B	D3B	P3A
DEHR33F221K□□□	3150Vdc	220pF±10%	7.0mm max.	7.5	6.0mm max.	C3B	D3B	P3A
DEHR33F271K□□□	3150Vdc	270pF±10%	7.0mm max.	7.5	6.0mm max.	C3B	D3B	P3A
DEHR33F331K□□□	3150Vdc	330pF±10%	8.0mm max.	7.5	6.0mm max.	A3B	B3B	N3A
DEHR33F391K□□□	3150Vdc	390pF±10%	9.0mm max.	7.5	6.0mm max.	A3B	B3B	N3A
DEHR33F471K□□□	3150Vdc	470pF±10%	10.0mm max.	7.5	6.0mm max.	A3B	B3B	N3A
DEHR33F561K□□□	3150Vdc	560pF±10%	10.0mm max.	7.5	6.0mm max.	A3B	B3B	N3A
DEHR33F681K□□□	3150Vdc	680pF±10%	11.0mm max.	7.5	6.0mm max.	A3B	B3B	N3A
DEHR33F821K□□□	3150Vdc	820pF±10%	12.0mm max.	7.5	6.0mm max.	A3B	B3B	N3A
DEHR33F102K□□□	3150Vdc	1000pF±10%	13.0mm max.	7.5	6.0mm max.	A3B	B3B	N3A
DEHR33F122K□□□	3150Vdc	1200pF±10%	14.0mm max.	7.5	6.0mm max.	A3B	B3B	N7A
DEHR33F152K□□□	3150Vdc	1500pF±10%	15.0mm max.	7.5	6.0mm max.	A3B	B3B	N7A
DEHR33F182K□□□	3150Vdc	1800pF±10%	16.0mm max.	7.5	6.0mm max.	A3B	B3B	N7A
DEHR33F222K□□□	3150Vdc	2200pF±10%	17.0mm max.	7.5	6.0mm max.	A3B	B3B	N7A
DEHR33F272K□□□	3150Vdc	2700pF±10%	19.0mm max.	10.0	6.0mm max.	A4B	B4B	-

Three blank columns are filled with the lead and packaging codes. Please refer to the three columns on the right for the appropriate code.

DEH Series Specifications and Test Methods

No.	Item	Specifications	Test Method									
1	Operating Temperature Range	-25 to +125°C										
2	Appearance and Dimensions	No visible defect, and dimensions are within specified range.	The capacitor should be visually inspected for evidence of defect. Dimensions should be measured with slide calipers.									
3	Marking	To be easily legible	The capacitor should be visually inspected.									
4	Between Lead Wires	No failure	The capacitor should not be damaged when DC voltage of 200% of the rated voltage is applied between the lead wires for 1 to 5 sec. (Charge/Discharge current ≤ 50mA)									
	Body Insulation	No failure	The capacitor is placed in the container with metal balls of diameter 1mm so that each lead wire, short circuited, is kept about 2mm off the metal balls as shown in the figure at right, and AC1250V(r.m.s.) <50/60Hz> is applied for 1 to 5 sec. between capacitor lead wires and metal balls. (Charge/Discharge current ≤ 50mA)									
5	Insulation Resistance (I.R.)	Between Lead Wires 10000MΩ min.	The insulation resistance should be measured with DC500±50V within 60±5 sec. of charging.									
6	Capacitance	Within specified tolerance	The capacitance should be measured at 20°C with 1±0.2kHz and AC5V(r.m.s.) max.									
7	Dissipation Factor (D.F.)	Char. R: 0.2% max.	The dissipation factor should be measured at 20°C with 1±0.2kHz and AC5V(r.m.s.) max.									
8	Temperature Characteristics	<table border="1"> <thead> <tr> <th rowspan="2">T. C.</th> <th colspan="2">Temp. Char.</th> </tr> <tr> <th>-25 to +85°C</th> <th>+85 to +125°C</th> </tr> </thead> <tbody> <tr> <td>R</td> <td>Within ±15%</td> <td>Within +15/-30%</td> </tr> </tbody> </table>	T. C.	Temp. Char.		-25 to +85°C	+85 to +125°C	R	Within ±15%	Within +15/-30%	The capacitance measurement should be made at each step specified in the Table.	
		T. C.		Temp. Char.								
-25 to +85°C	+85 to +125°C											
R	Within ±15%	Within +15/-30%										
<p>Pre-treatment: Capacitor should be stored at 125±3°C for 1 hr., then placed at room condition* for 24±2 hrs. before measurements.</p> <table border="1"> <thead> <tr> <th>Step</th> <th>1</th> <th>2</th> <th>3</th> <th>4</th> <th>5</th> </tr> </thead> <tbody> <tr> <td>Temp. (°C)</td> <td>20±2</td> <td>-25±3</td> <td>20±2</td> <td>125±2</td> <td>20±2</td> </tr> </tbody> </table>	Step	1	2	3	4	5	Temp. (°C)	20±2	-25±3	20±2	125±2	20±2
Step	1	2	3	4	5							
Temp. (°C)	20±2	-25±3	20±2	125±2	20±2							
9	Strength of Lead	Lead wire should not be cut off. Capacitor should not be broken.	As shown in the figure at right, fix the body of the capacitor and apply a tensile weight gradually to each lead wire in the radial direction of the capacitor up to 10N (5N for lead diameter 0.5mm), and keep it for 10±1 sec.									
	Bending		Each lead wire should be subjected to 5N (2.5N for lead diameter 0.5mm) of weight and bent 90° at the point of egress, in one direction, then returned to its original position and bent 90° in the opposite direction at the rate of one bend in 2 to 3 sec.									
10	Vibration Resistance	Appearance	The capacitor should be firmly soldered to the supporting lead wire and vibrated at a frequency range of 10 to 55Hz, 1.5mm in total amplitude, with about a 1-minute rate of vibration change from 10Hz to 55Hz and back to 10Hz. Apply for a total of 6 hrs., 2 hrs. each in 3 mutually perpendicular directions.									
		Capacitance										
		D.F.										
11	Solderability of Leads	Lead wire should be soldered with uniform coating on the axial direction over 3/4 of the circumferential direction.	The lead wire of a capacitor should be dipped into a ethanol solution of 25wt% rosin and then into molten solder for 2±0.5 sec. In both cases the depth of dipping is up to about 1.5 to 2mm from the root of lead wires. Temp. of solder: Lead Free Solder (Sn-3Ag-0.5Cu) 245±5°C H63 Eutectic Solder 235±5°C									
12	Soldering Effect (Non-Preheat)	Appearance	The lead wire should be immersed into the melted solder of 350±10°C up to about 1.5 to 2mm from the main body for 3.5±0.5 sec. Pre-treatment: Capacitor should be stored at 125±3°C for 1 hr., then placed at room condition* for 24±2 hrs. before initial measurements. Post-treatment: Capacitor should be stored for 24±2 hrs. at room condition.*									
		Capacitance Change										
		Dielectric Strength (Between Lead Wires)										

* "Room condition" Temperature: 15 to 35°C, Relative humidity: 45 to 75%, Atmospheric pressure: 86 to 106kPa

Continued on the following page. ↗

DEH Series Specifications and Test Methods

Continued from the preceding page. ↘

No.	Item	Specifications	Test Method															
13	Soldering Effect (On-Preheat)	Appearance	First the capacitor should be stored at 120+0/-5°C for 60+0/-5 sec. Then, as in the figure, the lead wires should be immersed in solder of 260+0/-5°C up to 1.5 to 2.0mm from the root of terminal for 7.5+0/-1 sec. Pre-treatment: Capacitor should be stored at 125±3°C for 1 hr., then placed at room condition* for 24±2 hrs. before initial measurements. Post-treatment: Capacitor should be stored for 24±2 hrs. at room condition.*															
	Capacitance Change	Within ±10%																
	Dielectric Strength (Between Lead Wires)	Per item 4.																
14	Temperature Cycle	Appearance	The capacitor should be subjected to 5 temperature cycles. <Temperature Cycle> <table border="1" style="margin: 10px auto;"> <thead> <tr> <th>Step</th> <th>Temperature (°C)</th> <th>Time (min)</th> </tr> </thead> <tbody> <tr> <td>1</td> <td>-25±3</td> <td>30</td> </tr> <tr> <td>2</td> <td>Room Temp.</td> <td>3</td> </tr> <tr> <td>3</td> <td>125±3</td> <td>30</td> </tr> <tr> <td>4</td> <td>Room Temp.</td> <td>3</td> </tr> </tbody> </table> Cycle time: 5 cycles Pre-treatment: Capacitor should be stored at 125±3°C for 1 hr., then placed at room condition* for 24±2 hrs. before initial measurements. Post-treatment: Capacitor should be stored for 24±2 hrs. at room condition.*	Step	Temperature (°C)	Time (min)	1	-25±3	30	2	Room Temp.	3	3	125±3	30	4	Room Temp.	3
		Step		Temperature (°C)	Time (min)													
		1		-25±3	30													
		2		Room Temp.	3													
		3		125±3	30													
4	Room Temp.	3																
Capacitance Change	Within ±10%																	
D.F.	0.4% max.																	
I.R.	1000MΩ min.																	
Dielectric Strength (Between Lead Wires)	Per item 4.																	
15	Humidity (Under Steady State)	Appearance	Set the capacitor for 500 +24/-0 hrs. at 40±2°C in 90 to 95% relative humidity. Pre-treatment: Capacitor should be stored at 125±3°C for 1 hr., then placed at room condition* for 24±2 hrs. before initial measurements. Post-treatment: Capacitor should be stored for 1 to 2 hrs. at room condition.*															
		Capacitance Change		Within ±10%														
		D.F.		0.4% max.														
		I.R.		1000MΩ min.														
16	Humidity Loading	Appearance	Apply the rated voltage for 500+24/-0 hrs. at 40±2°C in 90 to 95% relative humidity. (Charge/Discharge current≤50mA) Pre-treatment: Capacitor should be stored at 125±3°C for 1 hr., then placed at room condition* for 24±2 hrs. before initial measurements. Post-treatment: Capacitor should be stored for 1 to 2 hrs. at room condition.*															
		Capacitance Change		Within ±10%														
		D.F.		0.6% max.														
		I.R.		1000MΩ min.														
17	Life	Appearance	Apply a DC voltage of 150% of the rated voltage for 1000 +48/-0 hrs. at 125±2°C with a relative humidity of 50% max. (Charge/Discharge current≤50mA) Pre-treatment: Capacitor should be stored at 125±3°C for 1 hr., then placed at room condition* for 24±2 hrs. before initial measurements. Post-treatment: Capacitor should be stored at 125±3°C for 1 hr., then placed at room condition* for 24±2 hrs.															
		Capacitance Change		Within ±10%														
		D.F.		0.4% max.														
		I.R.		2000MΩ min.														

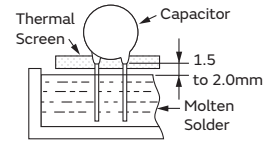

* "Room condition" Temperature: 15 to 35°C, Relative humidity: 45 to 75%, Atmospheric pressure: 86 to 106kPa

High Voltage Ceramic Capacitors

DEA Series (125°C Guaranteed/Class 1/DC2k-3.15kV)

Features

1. Temperature compensating type ceramics realize lower heat dissipation than DEH series.
2. Operating temperature range is guaranteed up to 125 degrees C.
3. Coated with flame-retardant epoxy resin (equivalent to UL94V-0 standard).
 Please contact us when a halogen-free product* is necessary.
 * Cl=900ppm max., Br=900ppm max. and Cl+Br=1500ppm max.
4. Taping available for automatic insertion.

Applications

1. Ideal for use as the ballast in backlighting inverters for liquid crystal display.
2. Ideal for use on high-frequency pulse circuits such as a horizontal resonance circuit for CTV and snubber circuits for switching power supplies.

Do not use these products in any automotive power train or safety equipment including battery chargers for electric vehicles and plug-in hybrids. Only Murata products clearly stipulated as "for Automotive use" on its catalog can be used for automobile applications such as power train and safety equipment.

Marking

Nominal Body Diameter	Temp. Char.	SL
ø4.5-5mm		68 2KV
ø6mm		39 3KV 66
ø7-9mm		181J 2KV 66
ø10-16mm		391J 3KV M66
Nominal Capacitance	Under 100pF: Actual value, 100pF and over: Marked with 3 figures	
Capacitance Tolerance	Marked with code (omitted for nominal body diameter ø6mm and under)	
Rated Voltage	Marked with code (for DC3.15kV, marked with 3KV)	
Manufacturer's Identification	Marked with  (omitted for nominal body diameter ø9mm and under)	
Manufactured Date Code	Abbreviation (omitted for nominal body diameter ø5mm and under)	



SL Characteristics

Part Number	DC Rated Voltage	Capacitance	Body Dia. D	Lead Spacing F (mm)	Body Thickness T	Lead Package Long Bulk	Lead Package Short Bulk	Lead Package Taping
DEA1X3D100J□□□	2000Vdc	10pF±5%	4.5mm max.	5.0	5.0mm max.	C1B	D1B	P2A
DEA1X3D120J□□□	2000Vdc	12pF±5%	4.5mm max.	5.0	5.0mm max.	C1B	D1B	P2A
DEA1X3D150J□□□	2000Vdc	15pF±5%	4.5mm max.	5.0	5.0mm max.	C1B	D1B	P2A
DEA1X3D180J□□□	2000Vdc	18pF±5%	4.5mm max.	5.0	5.0mm max.	C1B	D1B	P2A
DEA1X3D220J□□□	2000Vdc	22pF±5%	4.5mm max.	5.0	5.0mm max.	C1B	D1B	P2A
DEA1X3D270J□□□	2000Vdc	27pF±5%	4.5mm max.	5.0	5.0mm max.	C1B	D1B	P2A
DEA1X3D330J□□□	2000Vdc	33pF±5%	4.5mm max.	5.0	5.0mm max.	C1B	D1B	P2A
DEA1X3D390J□□□	2000Vdc	39pF±5%	5.0mm max.	5.0	5.0mm max.	C1B	D1B	P2A
DEA1X3D470J□□□	2000Vdc	47pF±5%	6.0mm max.	5.0	5.0mm max.	A2B	B2B	N2A
DEA1X3D560J□□□	2000Vdc	56pF±5%	6.0mm max.	5.0	5.0mm max.	A2B	B2B	N2A
DEA1X3D680J□□□	2000Vdc	68pF±5%	6.0mm max.	5.0	5.0mm max.	A2B	B2B	N2A
DEA1X3D820J□□□	2000Vdc	82pF±5%	7.0mm max.	5.0	5.0mm max.	A2B	B2B	N2A
DEA1X3D101J□□□	2000Vdc	100pF±5%	7.0mm max.	5.0	5.0mm max.	A2B	B2B	N2A
DEA1X3D121J□□□	2000Vdc	120pF±5%	8.0mm max.	5.0	5.0mm max.	A2B	B2B	N2A
DEA1X3D151J□□□	2000Vdc	150pF±5%	8.0mm max.	5.0	5.0mm max.	A2B	B2B	N2A
DEA1X3D181J□□□	2000Vdc	180pF±5%	9.0mm max.	5.0	5.0mm max.	A2B	B2B	N2A
DEA1X3D221J□□□	2000Vdc	220pF±5%	10.0mm max.	5.0	5.0mm max.	A2B	B2B	N2A
DEA1X3D271J□□□	2000Vdc	270pF±5%	11.0mm max.	5.0	5.0mm max.	A2B	B2B	N2A
DEA1X3D331J□□□	2000Vdc	330pF±5%	12.0mm max.	7.5	5.0mm max.	A3B	B3B	N3A
DEA1X3D391J□□□	2000Vdc	390pF±5%	13.0mm max.	7.5	5.0mm max.	A3B	B3B	N3A
DEA1X3D471J□□□	2000Vdc	470pF±5%	14.0mm max.	7.5	5.0mm max.	A3B	B3B	N7A
DEA1X3D561J□□□	2000Vdc	560pF±5%	15.0mm max.	7.5	5.0mm max.	A3B	B3B	N7A
DEA1X3F100J□□□	3150Vdc	10pF±5%	5.0mm max.	7.5	6.0mm max.	CDB	DDB	P3A
DEA1X3F120J□□□	3150Vdc	12pF±5%	5.0mm max.	7.5	6.0mm max.	CDB	DDB	P3A
DEA1X3F150J□□□	3150Vdc	15pF±5%	5.0mm max.	7.5	6.0mm max.	CDB	DDB	P3A
DEA1X3F180J□□□	3150Vdc	18pF±5%	5.0mm max.	7.5	6.0mm max.	CDB	DDB	P3A
DEA1X3F220J□□□	3150Vdc	22pF±5%	5.0mm max.	7.5	6.0mm max.	CDB	DDB	P3A
DEA1X3F270J□□□	3150Vdc	27pF±5%	6.0mm max.	7.5	6.0mm max.	C3B	D3B	P3A
DEA1X3F330J□□□	3150Vdc	33pF±5%	6.0mm max.	7.5	6.0mm max.	C3B	D3B	P3A
DEA1X3F390J□□□	3150Vdc	39pF±5%	6.0mm max.	7.5	6.0mm max.	C3B	D3B	P3A
DEA1X3F470J□□□	3150Vdc	47pF±5%	7.0mm max.	7.5	6.0mm max.	C3B	D3B	P3A
DEA1X3F560J□□□	3150Vdc	56pF±5%	7.0mm max.	7.5	6.0mm max.	C3B	D3B	P3A
DEA1X3F680J□□□	3150Vdc	68pF±5%	8.0mm max.	7.5	6.0mm max.	A3B	B3B	N3A
DEA1X3F820J□□□	3150Vdc	82pF±5%	8.0mm max.	7.5	6.0mm max.	A3B	B3B	N3A
DEA1X3F101J□□□	3150Vdc	100pF±5%	9.0mm max.	7.5	6.0mm max.	A3B	B3B	N3A
DEA1X3F121J□□□	3150Vdc	120pF±5%	10.0mm max.	7.5	6.0mm max.	A3B	B3B	N3A
DEA1X3F151J□□□	3150Vdc	150pF±5%	11.0mm max.	7.5	6.0mm max.	A3B	B3B	N3A
DEA1X3F181J□□□	3150Vdc	180pF±5%	11.0mm max.	7.5	6.0mm max.	A3B	B3B	N3A
DEA1X3F221J□□□	3150Vdc	220pF±5%	12.0mm max.	7.5	6.0mm max.	A3B	B3B	N3A
DEA1X3F271J□□□	3150Vdc	270pF±5%	14.0mm max.	7.5	6.0mm max.	A3B	B3B	N7A
DEA1X3F331J□□□	3150Vdc	330pF±5%	15.0mm max.	7.5	6.0mm max.	A3B	B3B	N7A
DEA1X3F391J□□□	3150Vdc	390pF±5%	16.0mm max.	7.5	6.0mm max.	A3B	B3B	N7A

Three blank columns are filled with the lead and packaging codes. Please refer to the three columns on the right for the appropriate code.

DEA Series Specifications and Test Methods

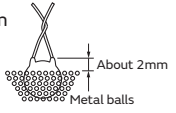
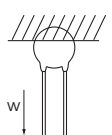
No.	Item	Specifications	Test Method										
1	Operating Temperature Range	-25 to +125°C											
2	Appearance and Dimensions	No visible defect, and dimensions are within specified range.	The capacitor should be visually inspected for evidence of defect. Dimensions should be measured with slide calipers.										
3	Marking	To be easily legible	The capacitor should be visually inspected.										
4	Between Lead Wires	No failure	The capacitor should not be damaged when DC voltage of 200% of the rated voltage is applied between the lead wires for 1 to 5 sec. (Charge/Discharge current ≤50mA)										
	Body Insulation	No failure	The capacitor is placed in the container with metal balls of diameter 1mm so that each lead wire, short circuited, is kept about 2mm off the metal balls as shown in the figure at right, and AC1250V(r.m.s.) <50/60Hz> is applied for 1 to 5 sec. between capacitor lead wires and metal balls. (Charge/Discharge current ≤50mA) 										
5	Insulation Resistance (I.R.)	Between Lead Wires 10000MΩ min.	The insulation resistance should be measured with DC500±50V within 60±5 sec. of charging.										
6	Capacitance	Within specified tolerance	The capacitance should be measured at 20°C with 1±0.2MHz and AC5V(r.m.s.) max.										
7	Q	400+20C*2min. (30pF under) 1000 min. (30pF min.)	The Q should be measured at 20°C with 1±0.2MHz and AC5V(r.m.s.) max.										
8	Temperature Characteristics	+350 to -1000ppm/°C (Temp. range: +20 to +85°C)	The capacitance measurement should be made at each step specified in the Table.										
		<table border="1" style="margin-left: auto; margin-right: auto;"> <thead> <tr> <th>Step</th> <th>1</th> <th>2</th> <th>3</th> <th>4</th> <th>5</th> </tr> </thead> <tbody> <tr> <td>Temp. (°C)</td> <td>20±2</td> <td>-25±3</td> <td>20±2</td> <td>85±2</td> <td>20±2</td> </tr> </tbody> </table>	Step	1	2	3	4	5	Temp. (°C)	20±2	-25±3	20±2	85±2
Step	1	2	3	4	5								
Temp. (°C)	20±2	-25±3	20±2	85±2	20±2								
9	Strength of Lead	Pull	As shown in the figure at right, fix the body of the capacitor and apply a tensile weight gradually to each lead wire in the radial direction of the capacitor up to 10N (5N for lead diameter 0.5mm), and keep it for 10±1 sec. 										
		Bending	Each lead wire should be subjected to 5N (2.5N for lead diameter 0.5mm) of weight and bent 90° at the point of egress, in one direction, then returned to its original position and bent 90° in the opposite direction at the rate of one bend in 2 to 3 sec.										
10	Vibration Resistance	Appearance	No marked defect										
		Capacitance	Within specified tolerance										
		Q	400+20C*2min. (30pF under) 1000 min. (30pF min.)										
11	Solderability of Leads	Lead wire should be soldered with uniform coating on the axial direction over 3/4 of the circumferential direction.	The lead wire of a capacitor should be dipped into a ethanol solution of 25wt% rosin and then into molten solder for 2±0.5 sec. In both cases the depth of dipping is up to about 1.5 to 2mm from the root of lead wires. Temp. of solder: Lead Free Solder (Sn-3Ag-0.5Cu) 245±5°C H63 Eutectic Solder 235±5°C										
12	Soldering Effect (Non-Preheat)	Appearance	No marked defect										
		Capacitance Change	Within ±2.5%										
		Dielectric Strength (Between Lead Wires)	Per item 4. The lead wire should be immersed into the melted solder of 350±10°C (Body of ø5mm and under: 270±5°C) up to about 1.5 to 2mm from the main body for 3.5±0.5 sec. (Body of ø5mm and under: 5±0.5 sec.) Post-treatment: Capacitor should be stored for 1 to 2 hrs. at room condition.*1										

*1 "Room condition" Temperature: 15 to 35°C, Relative humidity: 45 to 75%, Atmospheric pressure: 86 to 106kPa

*2 "C" expresses nominal capacitance value (pF).

Continued on the following page. ↗

DEA Series Specifications and Test Methods

Continued from the preceding page. ↘

No.	Item	Specifications	Test Method															
13	Appearance	No marked defect	First the capacitor should be stored at 120+0/-5°C for 60+0/-5 sec. Then, as in the figure, the lead wires should be immersed in solder of 260+0/-5°C up to 1.5 to 2.0mm from the root of terminal for 7.5+0/-1 sec. Post-treatment: Capacitor should be stored for 1 to 2 hrs. at room condition.*1															
	Capacitance Change	Within ±2.5%																
	Dielectric Strength (Between Lead Wires)	Per item 4.																
14	Appearance	No marked defect	The capacitor should be subjected to 5 temperature cycles. <Temperature Cycle> <table border="1" style="margin: 10px auto;"> <thead> <tr> <th>Step</th> <th>Temperature (°C)</th> <th>Time (min)</th> </tr> </thead> <tbody> <tr> <td>1</td> <td>-25±3</td> <td>30</td> </tr> <tr> <td>2</td> <td>Room Temp.</td> <td>3</td> </tr> <tr> <td>3</td> <td>125±3</td> <td>30</td> </tr> <tr> <td>4</td> <td>Room Temp.</td> <td>3</td> </tr> </tbody> </table> Cycle time: 5 cycles Post-treatment: Capacitor should be stored for 1 to 2 hrs. at room condition.*1	Step	Temperature (°C)	Time (min)	1	-25±3	30	2	Room Temp.	3	3	125±3	30	4	Room Temp.	3
	Step	Temperature (°C)		Time (min)														
	1	-25±3		30														
	2	Room Temp.		3														
	3	125±3		30														
4	Room Temp.	3																
Capacitance Change	Within ±5%																	
Q	275+5/2C*2min. (30pF under) 350 min. (30pF min.)																	
I.R.	1000MΩ min.																	
Dielectric Strength (Between Lead Wires)	Per item 4.																	
15	Appearance	No marked defect	Set the capacitor for 500+24/-0 hrs. at 40±2°C in 90 to 95% relative humidity. Post-treatment: Capacitor should be stored for 1 to 2 hrs. at room condition.*1															
	Capacitance Change	Within ±5%																
	Q	275+5/2C*2min. (30pF under) 350 min. (30pF min.)																
	I.R.	1000MΩ min.																
16	Appearance	No marked defect	Apply the rated voltage for 500+24/-0 hrs. at 40±2°C in 90 to 95% relative humidity. (Charge/Discharge current≤50mA) Post-treatment: Capacitor should be stored for 1 to 2 hrs. at room condition.*1															
	Capacitance Change	Within ±5%																
	Q	275+5/2C*2min. (30pF under) 350 min. (30pF min.)																
	I.R.	1000MΩ min.																
17	Appearance	No marked defect	Apply a DC voltage of 150% of the rated voltage for 1000+48/-0 hrs. at 125±2°C with a relative humidity of 50% max. (Charge/Discharge current≤50mA) Post-treatment: Capacitor should be stored for 1 to 2 hrs. at room condition.*1															
	Capacitance Change	Within ±3%																
	Q	275+5/2C*2min. (30pF under) 350 min. (30pF min.)																
	I.R.	2000MΩ min.																



*1 "Room condition" Temperature: 15 to 35°C, Relative humidity: 45 to 75%, Atmospheric pressure: 86 to 106kPa

*2 "C" expresses nominal capacitance value (pF).

High Voltage Ceramic Capacitors

DEB Series (Class 2/DC2k-3.15kV)

Features

1. Small size and high capacitance
2. Coated with flame-retardant epoxy resin (equivalent to UL94V-0 standard).
 Please contact us when a halogen-free product* is necessary.
 * Cl=900ppm max., Br=900ppm max. and Cl+Br=1500ppm max.
3. Taping available for automatic insertion.

Applications

Ideal for use on decoupling circuits for power supplies.

Do not use these products in any automotive power train or safety equipment including battery chargers for electric vehicles and plug-in hybrids. Only Murata products clearly stipulated as "for Automotive use" on its catalog can be used for automobile applications such as power train and safety equipment.

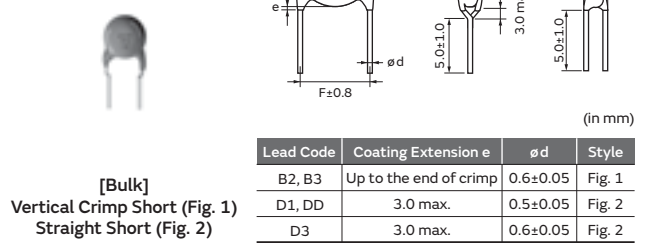

Marking

Nominal Body Diameter	Temp. Char.	B	E	F
		ø4.5-5mm	221 3KV	—
ø6mm		331 3KV 66	102 2KV 66	—
ø7-9mm		102K 3KV 66	102Z 3KV 66	472Z 2KV 66
ø10-16mm		B 332K 3KV M66	E 472Z 3KV M66	103Z 2KV M66
Temperature Characteristics		Marked with code for char. B and E (omitted for nominal body diameter ø9mm and under)		
Nominal Capacitance		Marked with 3 figures		
Capacitance Tolerance		Marked with code (omitted for nominal body diameter ø6mm and under)		
Rated Voltage		Marked with code (for DC3.15kV, marked with 3KV)		
Manufacturer's Identification		Marked with M (omitted for nominal body diameter ø9mm and under)		
Manufactured Date Code		Abbreviation (omitted for nominal body diameter ø5mm and under)		

B Characteristics

Part Number	DC Rated Voltage	Capacitance	Body Dia. D	Lead Spacing F (mm)	Body Thickness T	Lead Package Long Bulk	Lead Package Short Bulk	Lead Package Taping
DEBB33D101K□□□	2000Vdc	100pF±10%	4.5mm max.	5.0	5.0mm max.	C1B	D1B	P2A
DEBB33D151K□□□	2000Vdc	150pF±10%	4.5mm max.	5.0	5.0mm max.	C1B	D1B	P2A
DEBB33D221K□□□	2000Vdc	220pF±10%	4.5mm max.	5.0	5.0mm max.	C1B	D1B	P2A
DEBB33D331K□□□	2000Vdc	330pF±10%	5.0mm max.	5.0	5.0mm max.	C1B	D1B	P2A
DEBB33D471K□□□	2000Vdc	470pF±10%	6.0mm max.	5.0	5.0mm max.	A2B	B2B	N2A
DEBB33D681K□□□	2000Vdc	680pF±10%	7.0mm max.	5.0	5.0mm max.	A2B	B2B	N2A
DEBB33D102K□□□	2000Vdc	1000pF±10%	8.0mm max.	5.0	5.0mm max.	A2B	B2B	N2A
DEBB33D152K□□□	2000Vdc	1500pF±10%	9.0mm max.	5.0	5.0mm max.	A2B	B2B	N2A
DEBB33D222K□□□	2000Vdc	2200pF±10%	10.0mm max.	5.0	5.0mm max.	A2B	B2B	N2A
DEBB33D332K□□□	2000Vdc	3300pF±10%	12.0mm max.	7.5	5.0mm max.	A3B	B3B	N3A
DEBB33D472K□□□	2000Vdc	4700pF±10%	15.0mm max.	7.5	5.0mm max.	A3B	B3B	N7A
DEBB33F101K□□□	3150Vdc	100pF±10%	5.0mm max.	7.5	6.0mm max.	CDB	DDB	P3A
DEBB33F151K□□□	3150Vdc	150pF±10%	5.0mm max.	7.5	6.0mm max.	CDB	DDB	P3A
DEBB33F221K□□□	3150Vdc	220pF±10%	5.0mm max.	7.5	6.0mm max.	CDB	DDB	P3A
DEBB33F331K□□□	3150Vdc	330pF±10%	6.0mm max.	7.5	6.0mm max.	C3B	D3B	P3A
DEBB33F471K□□□	3150Vdc	470pF±10%	7.0mm max.	7.5	6.0mm max.	C3B	D3B	P3A
DEBB33F681K□□□	3150Vdc	680pF±10%	8.0mm max.	7.5	6.0mm max.	A3B	B3B	N3A
DEBB33F102K□□□	3150Vdc	1000pF±10%	9.0mm max.	7.5	6.0mm max.	A3B	B3B	N3A
DEBB33F152K□□□	3150Vdc	1500pF±10%	11.0mm max.	7.5	6.0mm max.	A3B	B3B	N3A
DEBB33F222K□□□	3150Vdc	2200pF±10%	13.0mm max.	7.5	6.0mm max.	A3B	B3B	N3A
DEBB33F332K□□□	3150Vdc	3300pF±10%	15.0mm max.	7.5	6.0mm max.	A3B	B3B	N7A

Three blank columns are filled with the lead and packaging codes. Please refer to the three columns on the right for the appropriate code.

6

E Characteristics

Part Number	DC Rated Voltage	Capacitance	Body Dia. D	Lead Spacing F (mm)	Body Thickness T	Lead Package Long Bulk	Lead Package Short Bulk	Lead Package Taping
DEBE33D102Z□□□	2000Vdc	1000pF+80/-20%	6.0mm max.	5.0	5.0mm max.	A2B	B2B	N2A
DEBE33D222Z□□□	2000Vdc	2200pF+80/-20%	8.0mm max.	5.0	5.0mm max.	A2B	B2B	N2A
DEBE33D472Z□□□	2000Vdc	4700pF+80/-20%	11.0mm max.	5.0	5.0mm max.	A2B	B2B	N2A
DEBE33D103Z□□□	2000Vdc	10000pF+80/-20%	16.0mm max.	7.5	5.0mm max.	A3B	B3B	N7A
DEBE33F102Z□□□	3150Vdc	1000pF+80/-20%	7.0mm max.	7.5	6.0mm max.	C3B	D3B	P3A
DEBE33F222Z□□□	3150Vdc	2200pF+80/-20%	10.0mm max.	7.5	6.0mm max.	A3B	B3B	N3A
DEBE33F472Z□□□	3150Vdc	4700pF+80/-20%	13.0mm max.	7.5	6.0mm max.	A3B	B3B	N3A

Three blank columns are filled with the lead and packaging codes. Please refer to the three columns on the right for the appropriate code.

F Characteristics

Part Number	DC Rated Voltage	Capacitance	Body Dia. D	Lead Spacing F (mm)	Body Thickness T	Lead Package Long Bulk	Lead Package Short Bulk	Lead Package Taping
DEBF33D102Z□□□	2000Vdc	1000pF+80/-20%	5.0mm max.	5.0	5.0mm max.	C1B	D1B	P2A
DEBF33D222Z□□□	2000Vdc	2200pF+80/-20%	7.0mm max.	5.0	5.0mm max.	A2B	B2B	N2A
DEBF33D472Z□□□	2000Vdc	4700pF+80/-20%	9.0mm max.	5.0	5.0mm max.	A2B	B2B	N2A
DEBF33D103Z□□□	2000Vdc	10000pF+80/-20%	12.0mm max.	7.5	5.0mm max.	A3B	B3B	N3A

Three blank columns are filled with the lead and packaging codes. Please refer to the three columns on the right for the appropriate code.

DEB Series Specifications and Test Methods

No.	Item	Specifications	Test Method												
1	Operating Temperature Range	-25 to +85°C													
2	Appearance and Dimensions	No visible defect, and dimensions are within specified range.	The capacitor should be visually inspected for evidence of defect. Dimensions should be measured with slide calipers.												
3	Marking	To be easily legible	The capacitor should be visually inspected.												
4	Between Lead Wires	No failure	The capacitor should not be damaged when DC voltage of 200% of the rated voltage is applied between the lead wires for 1 to 5 sec. (Charge/Discharge current ≤ 50mA) The capacitor is placed in the container with metal balls of diameter 1mm so that each lead wire, short circuited, is kept about 2mm off the metal balls as shown in the figure at right, and DC voltage of 1.3kV is applied for 1 to 5 sec. between capacitor lead wires and metal balls. (Charge/Discharge current ≤ 50mA) 												
	Body Insulation	No failure													
5	Insulation Resistance (I.R.)	Between Lead Wires 10000MΩ min.	The insulation resistance should be measured with DC500±50V within 60±5 sec. of charging.												
6	Capacitance	Within specified tolerance	The capacitance should be measured at 20°C with 1±0.2kHz and AC5V(r.m.s.) max.												
7	Dissipation Factor (D.F.)	Char. B, E: 2.5% max. Char. F: 5.0% max.	The dissipation factor should be measured at 20°C with 1±0.2kHz and AC5V(r.m.s.) max.												
8	Temperature Characteristics	Char. B: Within ±10% Char. E: Within +20/-55% Char. F: Within +30/-80%	The capacitance measurement should be made at each step specified in the Table. Pre-treatment: Capacitor should be stored at 85±2°C for 1 hr., then placed at room condition* for 24±2 hrs. before measurements. <table border="1" style="margin-left: auto; margin-right: auto;"> <thead> <tr> <th>Step</th> <th>1</th> <th>2</th> <th>3</th> <th>4</th> <th>5</th> </tr> </thead> <tbody> <tr> <td>Temp. (°C)</td> <td>20±2</td> <td>-25±3</td> <td>20±2</td> <td>85±2</td> <td>20±2</td> </tr> </tbody> </table>	Step	1	2	3	4	5	Temp. (°C)	20±2	-25±3	20±2	85±2	20±2
		Step		1	2	3	4	5							
Temp. (°C)	20±2	-25±3	20±2	85±2	20±2										
9	Pull	Lead wire should not be cut off. Capacitor should not be broken.	As shown in the figure at right, fix the body of the capacitor and apply a tensile weight gradually to each lead wire in the radial direction of the capacitor up to 10N (5N for lead diameter 0.5mm), and keep it for 10±1 sec. 												
	Bending		Each lead wire should be subjected to 5N (2.5N for lead diameter 0.5mm) of weight and bent 90° at the point of egress, in one direction, then returned to its original position and bent 90° in the opposite direction at the rate of one bend in 2 to 3 sec.												
10	Appearance	No marked defect	The capacitor should be firmly soldered to the supporting lead wire and vibrated at a frequency range of 10 to 55Hz, 1.5mm in total amplitude, with about a 1-minute rate of vibration change from 10Hz to 55Hz and back to 10Hz. Apply for a total of 6 hrs., 2 hrs. each in 3 mutually perpendicular directions.												
	Capacitance	Within specified tolerance													
	D.F.	Char. B, E: 2.5% max. Char. F: 5.0% max.													
11	Solderability of Leads	Lead wire should be soldered with uniform coating on the axial direction over 3/4 of the circumferential direction.	The lead wire of a capacitor should be dipped into a ethanol solution of 25wt% rosin and then into molten solder for 2±0.5 sec. In both cases the depth of dipping is up to about 1.5 to 2mm from the root of lead wires. Temp. of solder: Lead Free Solder (Sn-3Ag-0.5Cu) 245±5°C H63 Eutectic Solder 235±5°C												
12	Appearance	No marked defect	The lead wire should be immersed into the melted solder of 350±10°C (Body of ø5mm and under: 270±5°C) up to about 1.5 to 2mm from the main body for 3.5±0.5 sec. (Body of ø5mm and under: 5±0.5 sec.) Pre-treatment: Capacitor should be stored at 85±2°C for 1 hr., then placed at room condition* for 24±2 hrs. before initial measurements. Post-treatment: Capacitor should be stored for 4 to 24 hrs. at room condition.*												
	Capacitance Change	Char. B: Within ±5% Char. E: Within ±15% Char. F: Within ±20%													
	Dielectric Strength (Between Lead Wires)	Per item 4.													

* "Room condition" Temperature: 15 to 35°C, Relative humidity: 45 to 75%, Atmospheric pressure: 86 to 106kPa

Continued on the following page. ↗

DEB Series Specifications and Test Methods

Continued from the preceding page. ↘

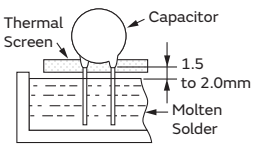
No.	Item	Specifications	Test Method																											
13	Soldering Effect (On-Preheat)	Appearance	No marked defect																											
		Capacitance Change	Char. B: Within $\pm 5\%$ Char. E: Within $\pm 15\%$ Char. F: Within $\pm 20\%$																											
		Dielectric Strength (Between Lead Wires)	Per item 4.																											
			<p>First the capacitor should be stored at $120 \pm 0/-5^\circ\text{C}$ for $60 \pm 0/-5$ sec. Then, as in the figure, the lead wires should be immersed in solder of $260 \pm 0/-5^\circ\text{C}$ up to 1.5 to 2.0mm from the root of terminal for $7.5 \pm 0/-1$ sec. Pre-treatment: Capacitor should be stored at $85 \pm 2^\circ\text{C}$ for 1 hr., then placed at room condition* for 24 ± 2 hrs. before initial measurements. Post-treatment: Capacitor should be stored for 4 to 24 hrs. at room condition.*</p> <div style="text-align: right;">  </div>																											
14	Temperature and Immersion Cycle	Appearance	No marked defect																											
		Capacitance Change	Char. B: Within $\pm 10\%$ Char. E: Within $\pm 20\%$ Char. F: Within $\pm 30\%$																											
		D.F.	Char. B, E: 4.0% max. Char. F: 7.5% max.																											
		I.R.	2000M Ω min.																											
		Dielectric Strength (Between Lead Wires)	Per item 4.																											
			<p>The capacitor should be subjected to 5 temperature cycles, then consecutively to 2 immersion cycles.</p> <p><Temperature Cycle></p> <table border="1" style="margin-left: auto; margin-right: auto;"> <thead> <tr style="background-color: #ccc;"> <th>Step</th> <th>Temperature ($^\circ\text{C}$)</th> <th>Time (min)</th> </tr> </thead> <tbody> <tr> <td>1</td> <td>-25 ± 3</td> <td>30</td> </tr> <tr> <td>2</td> <td>Room Temp.</td> <td>3</td> </tr> <tr> <td>3</td> <td>85 ± 3</td> <td>30</td> </tr> <tr> <td>4</td> <td>Room Temp.</td> <td>3</td> </tr> </tbody> </table> <p style="text-align: center;">Cycle time: 5 cycles</p> <p><Immersion Cycle></p> <table border="1" style="margin-left: auto; margin-right: auto;"> <thead> <tr style="background-color: #ccc;"> <th>Step</th> <th>Temperature ($^\circ\text{C}$)</th> <th>Time (min)</th> <th>Immersion Water</th> </tr> </thead> <tbody> <tr> <td>1</td> <td>$65 \pm 5/-0$</td> <td>15</td> <td>Clean water</td> </tr> <tr> <td>2</td> <td>0 ± 3</td> <td>15</td> <td>Salt water</td> </tr> </tbody> </table> <p style="text-align: center;">Cycle time : 2 cycles</p> <p>Pre-treatment: Capacitor should be stored at $85 \pm 2^\circ\text{C}$ for 1 hr., then placed at room condition* for 24 ± 2 hrs. before initial measurements. Post-treatment: Capacitor should be stored for 4 to 24 hrs. at room condition.*</p>	Step	Temperature ($^\circ\text{C}$)	Time (min)	1	-25 ± 3	30	2	Room Temp.	3	3	85 ± 3	30	4	Room Temp.	3	Step	Temperature ($^\circ\text{C}$)	Time (min)	Immersion Water	1	$65 \pm 5/-0$	15	Clean water	2	0 ± 3	15	Salt water
Step	Temperature ($^\circ\text{C}$)	Time (min)																												
1	-25 ± 3	30																												
2	Room Temp.	3																												
3	85 ± 3	30																												
4	Room Temp.	3																												
Step	Temperature ($^\circ\text{C}$)	Time (min)	Immersion Water																											
1	$65 \pm 5/-0$	15	Clean water																											
2	0 ± 3	15	Salt water																											
15	Humidity (Under Steady State)	Appearance	No marked defect																											
		Capacitance Change	Char. B: Within $\pm 10\%$ Char. E: Within $\pm 20\%$ Char. F: Within $\pm 30\%$																											
		D.F.	Char. B, E: 5.0% max. Char. F: 7.5% max.																											
		I.R.	1000M Ω min.																											
			<p>Set the capacitor for $500 \pm 24/-0$ hrs. at $40 \pm 2^\circ\text{C}$ in 90 to 95% relative humidity. Pre-treatment: Capacitor should be stored at $85 \pm 2^\circ\text{C}$ for 1 hr., then placed at room condition* for 24 ± 2 hrs. before initial measurements. Post-treatment: Capacitor should be stored for 1 to 2 hrs. at room condition.*</p>																											
16	Humidity Loading	Appearance	No marked defect																											
		Capacitance Change	Char. B: Within $\pm 10\%$ Char. E: Within $\pm 20\%$ Char. F: Within $\pm 30\%$																											
		D.F.	Char. B, E: 5.0% max. Char. F: 7.5% max.																											
		I.R.	500M Ω min.																											
			<p>Apply the rated voltage for $500 \pm 24/-0$ hrs. at $40 \pm 2^\circ\text{C}$ in 90 to 95% relative humidity. (Charge/Discharge current $\leq 50\text{mA}$) Pre-treatment: Capacitor should be stored at $85 \pm 2^\circ\text{C}$ for 1 hr., then placed at room condition* for 24 ± 2 hrs. before initial measurements. Post-treatment: Capacitor should be stored at $85 \pm 2^\circ\text{C}$ for 1 hr., then placed at room condition* for 24 ± 2 hrs.</p>																											
17	Life	Appearance	No marked defect																											
		Capacitance Change	Char. B: Within $\pm 10\%$ Char. E: Within $\pm 20\%$ Char. F: Within $\pm 30\%$																											
		D.F.	Char. B, E: 4.0% max. Char. F: 7.5% max.																											
		I.R.	2000M Ω min.																											
			<p>Apply a DC voltage of 150% of the rated voltage for $1000 \pm 48/-0$ hrs. at $85 \pm 2^\circ\text{C}$ with a relative humidity of 50% max. (Charge/Discharge current $\leq 50\text{mA}$) Pre-treatment: Capacitor should be stored at $85 \pm 2^\circ\text{C}$ for 1 hr., then placed at room condition* for 24 ± 2 hrs. before initial measurements. Post-treatment: Capacitor should be stored at $85 \pm 2^\circ\text{C}$ for 1 hr., then placed at room condition* for 24 ± 2 hrs.</p>																											

* "Room condition" Temperature: 15 to 35°C , Relative humidity: 45 to 75%, Atmospheric pressure: 86 to 106kPa

High Voltage Ceramic Capacitors

DEC Series (Class 1, 2/DC6.3kV)

Features

Coated with flame-retardant epoxy resin (equivalent to UL94V-0 standard).

Please contact us when a halogen-free product* is necessary.

* Cl=900ppm max., Br=900ppm max. and Cl+Br=1500ppm max.

Applications

1. Ideal for use as the ballast in backlighting inverters for liquid crystal displays (SL Char.).
2. Ideal for use on high voltage circuits such as Cockcroft circuits (B Char.).

Do not use these products in any automotive power train or safety equipment including battery chargers for electric vehicles and plug-in hybrids. Only Murata products clearly stipulated as "for Automotive use" on its catalog can be used for automobile applications such as power train and safety equipment.

Marking

Nominal Body Diameter	Temp. Char.	SL	B	E
	ø7mm		10J 6KV	—
ø8-9mm		47J 6KV 66	331K 6KV 66	—
ø10-15mm		151J 6KV M66	B 102K 6KV M66	222Z 6KV M66
Temperature Characteristics		Marked with code for char. B (omitted for nominal body diameter ø9mm and under)		
Nominal Capacitance		Under 100pF: Actual value, 100pF and over: Marked with 3 figures		
Capacitance Tolerance		Marked with code		
Rated Voltage		Marked with code (for DC6.3kV, marked with 6KV)		
Manufacturer's Identification		Marked with  (omitted for nominal body diameter ø9mm and under)		
Manufactured Date Code		Abbreviation (omitted for nominal body diameter ø7mm)		



SL Characteristics

Part Number	DC Rated Voltage	Capacitance	Body Dia. D	Lead Spacing F (mm)	Body Thickness T
DEC1X3J100JA3BMS1	6300Vdc	10pF±5%	7.0mm max.	7.5	7.0mm max.
DEC1X3J100JC4BMS1	6300Vdc	10pF±5%	7.0mm max.	10.0	7.0mm max.
DEC1X3J120JA3B	6300Vdc	12pF±5%	8.0mm max.	7.5	7.0mm max.
DEC1X3J120JC4B	6300Vdc	12pF±5%	8.0mm max.	10.0	7.0mm max.
DEC1X3J150JA3B	6300Vdc	15pF±5%	8.0mm max.	7.5	7.0mm max.
DEC1X3J150JC4B	6300Vdc	15pF±5%	8.0mm max.	10.0	7.0mm max.
DEC1X3J180JA3B	6300Vdc	18pF±5%	9.0mm max.	7.5	7.0mm max.
DEC1X3J180JC4B	6300Vdc	18pF±5%	9.0mm max.	10.0	7.0mm max.
DEC1X3J220JA3B	6300Vdc	22pF±5%	9.0mm max.	7.5	7.0mm max.
DEC1X3J220JC4B	6300Vdc	22pF±5%	9.0mm max.	10.0	7.0mm max.
DEC1X3J270JA3B	6300Vdc	27pF±5%	9.0mm max.	7.5	7.0mm max.
DEC1X3J270JC4B	6300Vdc	27pF±5%	9.0mm max.	10.0	7.0mm max.
DEC1X3J330JA3B	6300Vdc	33pF±5%	9.0mm max.	7.5	7.0mm max.
DEC1X3J330JC4B	6300Vdc	33pF±5%	9.0mm max.	10.0	7.0mm max.
DEC1X3J390JA3B	6300Vdc	39pF±5%	9.0mm max.	7.5	7.0mm max.
DEC1X3J390JC4B	6300Vdc	39pF±5%	9.0mm max.	10.0	7.0mm max.
DEC1X3J470JA3B	6300Vdc	47pF±5%	9.0mm max.	7.5	7.0mm max.
DEC1X3J470JC4B	6300Vdc	47pF±5%	9.0mm max.	10.0	7.0mm max.
DEC1X3J560JC4B	6300Vdc	56pF±5%	10.0mm max.	10.0	7.0mm max.
DEC1X3J680JC4B	6300Vdc	68pF±5%	12.0mm max.	10.0	7.0mm max.
DEC1X3J820JC4B	6300Vdc	82pF±5%	12.0mm max.	10.0	7.0mm max.
DEC1X3J101JC4B	6300Vdc	100pF±5%	13.0mm max.	10.0	7.0mm max.
DEC1X3J121JC4B	6300Vdc	120pF±5%	14.0mm max.	10.0	7.0mm max.
DEC1X3J151JC4B	6300Vdc	150pF±5%	15.0mm max.	10.0	7.0mm max.

B Characteristics

Part Number	DC Rated Voltage	Capacitance	Body Dia. D	Lead Spacing F (mm)	Body Thickness T
DECB33J101KC4B	6300Vdc	100pF±10%	9.0mm max.	10.0	7.0mm max.
DECB33J151KC4B	6300Vdc	150pF±10%	9.0mm max.	10.0	7.0mm max.
DECB33J221KC4B	6300Vdc	220pF±10%	9.0mm max.	10.0	7.0mm max.
DECB33J331KC4B	6300Vdc	330pF±10%	9.0mm max.	10.0	7.0mm max.
DECB33J471KC4B	6300Vdc	470pF±10%	10.0mm max.	10.0	7.0mm max.
DECB33J681KC4B	6300Vdc	680pF±10%	11.0mm max.	10.0	7.0mm max.
DECB33J102KC4B	6300Vdc	1000pF±10%	13.0mm max.	10.0	7.0mm max.

E Characteristics

Part Number	DC Rated Voltage	Capacitance	Body Dia. D	Lead Spacing F (mm)	Body Thickness T
DECE33J102ZC4B	6300Vdc	1000pF+80/-20%	11.0mm max.	10.0	7.0mm max.
DECE33J222ZC4B	6300Vdc	2200pF+80/-20%	15.0mm max.	10.0	7.0mm max.

DEC Series Specifications and Test Methods

No.	Item	Specifications	Test Method												
1	Operating Temperature Range	-25 to +85°C													
2	Appearance and Dimensions	No visible defect, and dimensions are within specified range.	The capacitor should be visually inspected for evidence of defect. Dimensions should be measured with slide calipers.												
3	Marking	To be easily legible	The capacitor should be visually inspected.												
4	Dielectric Strength	Between Lead Wires No failure	The capacitor should not be damaged when DC voltage of 200% of the rated voltage is applied between the lead wires for 1 to 5 sec. (Charge/Discharge current ≤ 50mA)												
		Body Insulation No failure	The capacitor is placed in the container with metal balls of diameter 1mm so that each lead wire, short circuited, is kept about 2mm off the metal balls as shown in the figure at right, and DC voltage of 1.3kV is applied for 1 to 5 sec. between capacitor lead wires and metal balls. (Charge/Discharge current ≤ 50mA)												
5	Insulation Resistance (I.R.)	Between Lead Wires 10000MΩ min.	The insulation resistance should be measured with DC500±50V within 60±5 sec. of charging.												
6	Capacitance	Within specified tolerance	The capacitance should be measured at 20°C with 1±0.2kHz (Char. SL: 1±0.2MHz) and AC5V(r.m.s.) max.												
7	Q	Char. SL: 400+20C*2min. (30pF under) 1000 min. (30pF min.)	The dissipation factor and Q should be measured at 20°C with 1±0.2kHz (Char. SL: 1±0.2MHz) and AC5V(r.m.s.) max.												
	Dissipation Factor (D.F.)	Char. B, E: 2.5% max.													
8	Temperature Characteristics	Char. SL: +350 to -1000ppm/°C (Temp. range: +20 to +85°C) Char. B: Within ±10% Char. E: Within +20/-55%	The capacitance measurement should be made at each step specified in the Table.												
		Pre-treatment: Capacitor should be stored at 85±2°C for 1 hr., then placed at room condition*1 for 24±2 hrs. before measurements. (Char. B, E)													
		<table border="1" style="margin-left: auto; margin-right: auto;"> <thead> <tr> <th>Step</th> <th>1</th> <th>2</th> <th>3</th> <th>4</th> <th>5</th> </tr> </thead> <tbody> <tr> <td>Temp. (°C)</td> <td>20±2</td> <td>-25±3</td> <td>20±2</td> <td>85±2</td> <td>20±2</td> </tr> </tbody> </table>	Step	1	2	3	4	5	Temp. (°C)	20±2	-25±3	20±2	85±2	20±2	
Step	1	2	3	4	5										
Temp. (°C)	20±2	-25±3	20±2	85±2	20±2										
9	Strength of Lead	Pull	Lead wire should not be cut off. Capacitor should not be broken.	As shown in the figure at right, fix the body of the capacitor and apply a tensile weight gradually to each lead wire in the radial direction of the capacitor up to 10N and keep it for 10±1 sec.											
		Bending		Each lead wire should be subjected to 5N of weight and bent 90° at the point of egress, in one direction, then returned to its original position and bent 90° in the opposite direction at the rate of one bend in 2 to 3 sec.											
10	Vibration Resistance	Appearance	No marked defect	The capacitor should be firmly soldered to the supporting lead wire and vibrated at a frequency range of 10 to 55Hz, 1.5mm in total amplitude, with about a 1-minute rate of vibration change from 10Hz to 55Hz and back to 10Hz. Apply for a total of 6 hrs., 2 hrs. each in 3 mutually perpendicular directions.											
		Capacitance	Within specified tolerance												
		Q	Char. SL: 400+20C*2min. (30pF under) 1000 min. (30pF min.)												
		D.F.	Char. B, E: 2.5% max.												
11	Solderability of Leads	Lead wire should be soldered with uniform coating on the axial direction over 3/4 of the circumferential direction.	The lead wire of a capacitor should be dipped into a ethanol solution of 25wt% rosin and then into molten solder for 2±0.5 sec. In both cases the depth of dipping is up to about 1.5 to 2mm from the root of lead wires. Temp. of solder: Lead Free Solder (Sn-3Ag-0.5Cu) 245±5°C H63 Eutectic Solder 235±5°C												
12	Soldering Effect (Non-Preheat)	Appearance	No marked defect	The lead wire should be immersed into the melted solder of 350±10°C up to about 1.5 to 2mm from the main body for 3.5±0.5 sec. Pre-treatment: Capacitor should be stored at 85±2°C for 1 hr., then placed at room condition*1 for 24±2 hrs. before initial measurements. (Char. B, E) Post-treatment: Capacitor should be stored for 1 to 2 hrs. at room condition.*1 (Char. SL) Post-treatment: Capacitor should be stored for 4 to 24 hrs. at room condition.*1 (Char. B, E)											
		Capacitance Change	Char. SL: Within ±2.5% Char. B: Within ±5% Char. E: Within ±15%												
		Dielectric Strength (Between Lead Wires)	Per item 4.												

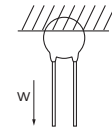
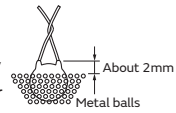

*1 "Room condition" Temperature: 15 to 35°C, Relative humidity: 45 to 75%, Atmospheric pressure: 86 to 106kPa

*2 "C" expresses nominal capacitance value (pF).

Continued on the following page. ↗

DEC Series Specifications and Test Methods

Continued from the preceding page. ↘

No.	Item	Specifications	Test Method																													
13	Soldering Effect (On-Preheat)	Appearance Capacitance Change Dielectric Strength (Between Lead Wires)	 <p>First the capacitor should be stored at 120+0/-5°C for 60+0/-5 sec. Then, as in the figure, the lead wires should be immersed in solder of 260+0/-5°C up to 1.5 to 2.0mm from the root of terminal for 7.5+0/-1 sec. Pre-treatment: Capacitor should be stored at 85±2°C for 1 hr., then placed at room condition*1 for 24±2 hrs. before initial measurements. (Char. B, E) Post-treatment: Capacitor should be stored for 1 to 2 hrs. at room condition.*1 (Char. SL) Post-treatment: Capacitor should be stored for 4 to 24 hrs. at room condition.*1 (Char. B, E)</p>																													
	14	Temperature and Immersion Cycle		Appearance Capacitance Change Q D.F. I.R. Dielectric Strength (Between Lead Wires)	<p>The capacitor should be subjected to 5 temperature cycles, then consecutively to 2 immersion cycles.</p> <p><Temperature Cycle></p> <table border="1"> <thead> <tr> <th>Step</th> <th>Temperature (°C)</th> <th>Time (min)</th> </tr> </thead> <tbody> <tr> <td>1</td> <td>-25±3</td> <td>30</td> </tr> <tr> <td>2</td> <td>Room Temp.</td> <td>3</td> </tr> <tr> <td>3</td> <td>85±3</td> <td>30</td> </tr> <tr> <td>4</td> <td>Room Temp.</td> <td>3</td> </tr> </tbody> </table> <p>Cycle time: 5 cycles</p> <p><Immersion Cycle></p> <table border="1"> <thead> <tr> <th>Step</th> <th>Temperature (°C)</th> <th>Time (min)</th> <th>Immersion Water</th> </tr> </thead> <tbody> <tr> <td>1</td> <td>65+5/-0</td> <td>15</td> <td>Clean water</td> </tr> <tr> <td>2</td> <td>0±3</td> <td>15</td> <td>Salt water</td> </tr> </tbody> </table> <p>Cycle time: 2 cycles</p> <p>Pre-treatment: Capacitor should be stored at 85±2°C for 1 hr., then placed at room condition*1 for 24±2 hrs. before initial measurements. (Char. B, E) Post-treatment: Capacitor should be stored for 4 to 24 hrs. at room condition.*1</p>	Step	Temperature (°C)	Time (min)	1	-25±3	30	2	Room Temp.	3	3	85±3	30	4	Room Temp.	3	Step	Temperature (°C)	Time (min)	Immersion Water	1	65+5/-0	15	Clean water	2	0±3	15	Salt water
		Step		Temperature (°C)		Time (min)																										
1		-25±3	30																													
2		Room Temp.	3																													
3		85±3	30																													
4	Room Temp.	3																														
Step	Temperature (°C)	Time (min)	Immersion Water																													
1	65+5/-0	15	Clean water																													
2	0±3	15	Salt water																													
15	Humidity (Under Steady State)	Appearance Capacitance Change Q D.F. I.R.	<p>Set the capacitor for 500+24/-0 hrs. at 40±2°C in 90 to 95% relative humidity. Pre-treatment: Capacitor should be stored at 85±2°C for 1 hr., then placed at room condition*1 for 24±2 hrs. before initial measurements. (Char. B, E) Post-treatment: Capacitor should be stored for 1 to 2 hrs. at room condition.*1</p>																													
	16	Humidity Loading		Appearance Capacitance Change Q D.F. I.R.	<p>Apply the rated voltage for 500+24/-0 hrs. at 40±2°C in 90 to 95% relative humidity. (Charge/Discharge current ≤50mA) Pre-treatment: Capacitor should be stored at 85±2°C for 1 hr., then placed at room condition*1 for 24±2 hrs. before initial measurements. (Char. B, E) Post-treatment: Capacitor should be stored for 1 to 2 hrs. at room condition.*1 (Char. SL) Post-treatment: Capacitor should be stored at 85±2°C for 1 hr., then placed at room condition*1 for 24±2 hrs. (Char. B, E)</p>																											
		17		Life		Appearance Capacitance Change Q D.F. I.R.	<p>Apply a DC voltage of 150% of the rated voltage for 1000+48/-0 hrs. at 85±2°C with a relative humidity of 50% max. (Charge/Discharge current ≤50mA) Pre-treatment: Capacitor should be stored at 85±2°C for 1 hr., then placed at room condition*1 for 24±2 hrs. before initial measurements. (Char. B, E) Post-treatment: Capacitor should be stored for 1 to 2 hrs. at room condition.*1 (Char. SL) Post-treatment: Capacitor should be stored at 85±2°C for 1 hr., then placed at room condition*1 for 24±2 hrs. (Char. B, E)</p>																									

*1 "Room condition" Temperature: 15 to 35°C, Relative humidity: 45 to 75%, Atmospheric pressure: 86 to 106kPa

*2 "C" expresses nominal capacitance value (pF).

High Voltage Ceramic Capacitors

DEF Series (Only for LCD Backlight Inverter Circuit/6.3kVp-p)

Features

1. Compact size: Diameter is 20% less than DEC series.
2. Low self-heating at high frequency and high voltage due to low dielectric loss of the ceramic material.
3. Operating temperature range is guaranteed up to 105 degrees C.
4. Coated with flame-retardant epoxy resin (equivalent to UL94V-0 standard).
 Please contact us when a halogen-free product* is necessary.
 * Cl=900ppm max., Br=900ppm max. and Cl+Br=1500ppm max.
5. Taping available for automatic insertion.

Applications

Ideal for use in LCD backlight inverters.

Do not use these products in any automotive power train or safety equipment including battery chargers for electric vehicles and plug-in hybrids. Only Murata products clearly stipulated as "for Automotive use" on its catalog can be used for automobile applications such as power train and safety equipment.

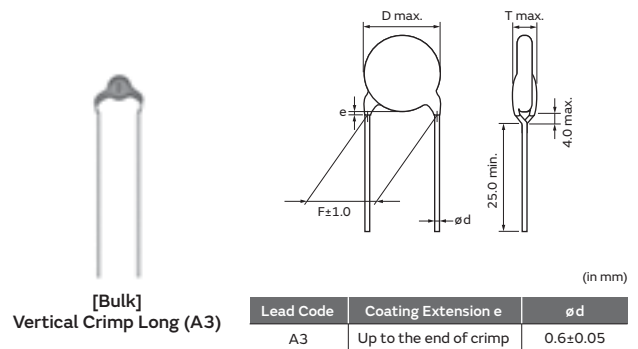

Marking

Nominal Body Diameter	Temp. Char.	
	CH	SL
φ7-9mm	10J 6K- 66	33J 6K- 66
Temperature Characteristics	Upper horizontal line	-
Nominal Capacitance	Actual value	
Capacitance Tolerance	Marked with code	
Rated Voltage	Marked with code (Marked with 6K-)	
Manufactured Date Code	Abbreviation	

SL Characteristics

Part Number	Rated Voltage	Capacitance	Body Dia. D	Lead Spacing F (mm)	Body Thickness T	Lead Package Long Bulk	Lead Package Short Bulk	Lead Package Taping
DEF1XLH100J□□□	6300Vdc(p-p)	10pF±5%	7.0mm max.	7.5	6.0mm max.	A3B	J3B	N3A
DEF1XLH120J□□□	6300Vdc(p-p)	12pF±5%	7.0mm max.	7.5	6.0mm max.	A3B	J3B	N3A
DEF1XLH150J□□□	6300Vdc(p-p)	15pF±5%	7.0mm max.	7.5	6.0mm max.	A3B	J3B	N3A
DEF1XLH180J□□□	6300Vdc(p-p)	18pF±5%	7.0mm max.	7.5	6.0mm max.	A3B	J3B	N3A
DEF1XLH220J□□□	6300Vdc(p-p)	22pF±5%	7.0mm max.	7.5	6.0mm max.	A3B	J3B	N3A
DEF1XLH270J□□□	6300Vdc(p-p)	27pF±5%	8.0mm max.	7.5	6.0mm max.	A3B	J3B	N3A
DEF1XLH330J□□□	6300Vdc(p-p)	33pF±5%	9.0mm max.	7.5	6.0mm max.	A3B	J3B	N3A
DEF1XLH390J□□□	6300Vdc(p-p)	39pF±5%	9.0mm max.	7.5	6.0mm max.	A3B	J3B	N3A
DEF1XLH470J□□□	6300Vdc(p-p)	47pF±5%	9.0mm max.	7.5	6.0mm max.	A3B	J3B	N3A

Three blank columns are filled with the lead and packaging codes. Please refer to the three columns on the right for the appropriate code.

CH Characteristics

Part Number	Rated Voltage	Capacitance	Body Dia. D	Lead Spacing F (mm)	Body Thickness T	Lead Package Long Bulk	Lead Package Short Bulk	Lead Package Taping
DEF2CLH020C□□□	6300Vdc(p-p)	2.0pF±0.25pF	7.0mm max.	7.5	6.0mm max.	A3B	J3B	N3A
DEF2CLH030C□□□	6300Vdc(p-p)	3.0pF±0.25pF	7.0mm max.	7.5	6.0mm max.	A3B	J3B	N3A
DEF2CLH040C□□□	6300Vdc(p-p)	4.0pF±0.25pF	7.0mm max.	7.5	6.0mm max.	A3B	J3B	N3A
DEF2CLH050D□□□	6300Vdc(p-p)	5.0pF±0.5pF	7.0mm max.	7.5	6.0mm max.	A3B	J3B	N3A
DEF2CLH060D□□□	6300Vdc(p-p)	6.0pF±0.5pF	7.0mm max.	7.5	6.0mm max.	A3B	J3B	N3A
DEF2CLH070D□□□	6300Vdc(p-p)	7.0pF±0.5pF	8.0mm max.	7.5	6.0mm max.	A3B	J3B	N3A
DEF2CLH080D□□□	6300Vdc(p-p)	8.0pF±0.5pF	8.0mm max.	7.5	6.0mm max.	A3B	J3B	N3A
DEF2CLH090D□□□	6300Vdc(p-p)	9.0pF±0.5pF	8.0mm max.	7.5	6.0mm max.	A3B	J3B	N3A
DEF2CLH100J□□□	6300Vdc(p-p)	10pF±5%	8.0mm max.	7.5	6.0mm max.	A3B	J3B	N3A

Three blank columns are filled with the lead and packaging codes. Please refer to the three columns on the right for the appropriate code.

DEF Series Specifications and Test Methods

No.	Item	Specifications	Test Method										
1	Operating Temperature Range	-25 to +105°C											
2	Appearance and Dimensions	No visible defect, and dimensions are within specified range.	The capacitor should be visually inspected for evidence of defect. Dimensions should be measured with slide calipers.										
3	Marking	To be easily legible	The capacitor should be visually inspected.										
4	Between Lead Wires	No failure	The capacitor should not be damaged when DC12.6kV is applied between the lead wires for 1 to 5 sec. (Charge/Discharge current ≤ 50mA)										
	Dielectric Strength Body Insulation	No failure	The capacitor is placed in the container with metal balls of diameter 1mm so that each lead wire, short circuited, is kept about 2.0mm off the metal balls as shown in the figure at right, and DC voltage of 1.3kV is applied for 1 to 5 sec. between capacitor lead wires and metal balls. (Charge/Discharge current ≤ 50mA)										
5	Insulation Resistance (I.R.)	Between Lead Wires 10000MΩ min.	The insulation resistance should be measured with DC500±50V within 60±5 sec. of charging.										
6	Capacitance	Within specified tolerance	The capacitance should be measured at 20°C with 1±0.2MHz and AC5V(r.m.s.) max.										
7	Q	400+20C* ² min. (30pF under) 1000 min. (30pF min.)	The Q should be measured at 20°C with 1±0.2MHz and AC5V(r.m.s.) max.										
8	Temperature Characteristics	Char. CH: 0±60ppm/°C Char. SL: +350 to -1000ppm/°C (Temp. range: +20 to +85°C)	The capacitance measurement should be made at each step specified in the Table.										
		<table border="1" style="margin-left: auto; margin-right: auto;"> <thead> <tr> <th>Step</th> <th>1</th> <th>2</th> <th>3</th> <th>4</th> <th>5</th> </tr> </thead> <tbody> <tr> <td>Temp. (°C)</td> <td>20±2</td> <td>-25±3</td> <td>20±2</td> <td>85±2</td> <td>20±2</td> </tr> </tbody> </table>	Step	1	2	3	4	5	Temp. (°C)	20±2	-25±3	20±2	85±2
Step	1	2	3	4	5								
Temp. (°C)	20±2	-25±3	20±2	85±2	20±2								
9	Strength of Lead	Lead wire should not be cut off. Capacitor should not be broken.	As shown in the figure at right, fix the body of the capacitor and apply a tensile weight gradually to each lead wire in the radial direction of the capacitor up to 10N and keep it for 10±1 sec.										
	Bending		Each lead wire should be subjected to 5N of weight and bent 90° at the point of egress, in one direction, then returned to its original position and bent 90° in the opposite direction at the rate of one bend in 2 to 3 sec.										
10	Vibration Resistance	Appearance	The capacitor should be firmly soldered to the supporting lead wire and vibrated at a frequency range of 10 to 55Hz, 1.5mm in total amplitude, with about a 1-minute rate of vibration change from 10Hz to 55Hz and back to 10Hz. Apply for a total of 6 hrs., 2 hrs. each in 3 mutually perpendicular directions.										
		Capacitance											
		Q											
11	Solderability of Leads	Lead wire should be soldered with uniform coating on the axial direction over 3/4 of the circumferential direction.	The lead wire of a capacitor should be dipped into a ethanol solution of 25wt% rosin and then into molten solder for 2±0.5 sec. In both cases the depth of dipping is up to about 1.5 to 2.0mm from the root of lead wires. Temp. of solder: Lead Free Solder (Sn-3Ag-0.5Cu) 245±5°C H63 Eutectic Solder 235±5°C										
12	Soldering Effect (Non-Preheat)	Appearance	The lead wire should be immersed into the melted solder of 350±10°C up to about 1.5 to 2.0mm from the main body for 3.5±0.5 sec. Post-treatment: Capacitor should be stored for 1 to 2 hrs. at room condition.* ¹										
		Capacitance Change											
		Dielectric Strength (Between Lead Wires)											

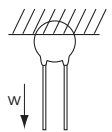
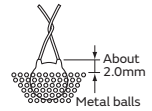

*¹ "Room condition" Temperature: 15 to 35°C, Relative humidity: 45 to 75%, Atmospheric pressure: 86 to 106kPa

*² "C" expresses nominal capacitance value (pF).

Continued on the following page. ↗

DEF Series Specifications and Test Methods

Continued from the preceding page. ↘

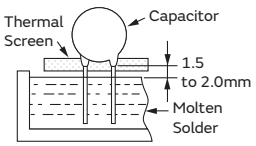
No.	Item	Specifications	Test Method																											
13	Soldering Effect (On-Preheat)	Appearance	No marked defect																											
		Capacitance Change	Within $\pm 2.5\%$																											
		Dielectric Strength (Between Lead Wires)	Per item 4.																											
<p>First the capacitor should be stored at $120 \pm 0/-5^\circ\text{C}$ for $60 \pm 0/-5$ sec. Then, as in the figure, the lead wires should be immersed in solder of $260 \pm 0/-5^\circ\text{C}$ up to 1.5 to 2.0mm from the root of terminal for $7.5 \pm 0/-1$ sec. Post-treatment: Capacitor should be stored for 1 to 2 hrs. at room condition.*¹</p> <div style="text-align: right;">  </div>																														
14	Temperature and Immersion Cycle	Appearance	No marked defect																											
		Capacitance Change	Within $\pm 3\%$																											
		Q	$200 + 10C^{*2}$ min. (10pF under) $275 + 5/2C^{*2}$ min. (10pF min. and 30pF under) 350 min. (30pF min.)																											
		I.R.	2000M Ω min.																											
		Dielectric Strength (Between Lead Wires)	Per item 4.																											
<p>The capacitor should be subjected to 5 temperature cycles, then consecutively to 2 immersion cycles.</p> <p><Temperature Cycle></p> <table border="1" style="margin-left: auto; margin-right: auto;"> <thead> <tr style="background-color: #444; color: white;"> <th>Step</th> <th>Temperature ($^\circ\text{C}$)</th> <th>Time (min)</th> </tr> </thead> <tbody> <tr> <td>1</td> <td>-25 ± 3</td> <td>30</td> </tr> <tr> <td>2</td> <td>Room Temp.</td> <td>3</td> </tr> <tr> <td>3</td> <td>105 ± 3</td> <td>30</td> </tr> <tr> <td>4</td> <td>Room Temp.</td> <td>3</td> </tr> </tbody> </table> <p style="text-align: right;">Cycle time: 5 cycles</p> <p><Immersion Cycle></p> <table border="1" style="margin-left: auto; margin-right: auto;"> <thead> <tr style="background-color: #444; color: white;"> <th>Step</th> <th>Temperature ($^\circ\text{C}$)</th> <th>Time (min)</th> <th>Immersion Water</th> </tr> </thead> <tbody> <tr> <td>1</td> <td>$65 \pm 5/-0$</td> <td>15</td> <td>Clean water</td> </tr> <tr> <td>2</td> <td>0 ± 3</td> <td>15</td> <td>Salt water</td> </tr> </tbody> </table> <p style="text-align: right;">Cycle time: 2 cycles</p> <p>Post-treatment: Capacitor should be stored for 4 to 24 hrs. at room condition.*¹</p>				Step	Temperature ($^\circ\text{C}$)	Time (min)	1	-25 ± 3	30	2	Room Temp.	3	3	105 ± 3	30	4	Room Temp.	3	Step	Temperature ($^\circ\text{C}$)	Time (min)	Immersion Water	1	$65 \pm 5/-0$	15	Clean water	2	0 ± 3	15	Salt water
Step	Temperature ($^\circ\text{C}$)	Time (min)																												
1	-25 ± 3	30																												
2	Room Temp.	3																												
3	105 ± 3	30																												
4	Room Temp.	3																												
Step	Temperature ($^\circ\text{C}$)	Time (min)	Immersion Water																											
1	$65 \pm 5/-0$	15	Clean water																											
2	0 ± 3	15	Salt water																											
15	Humidity (Under Steady State)	Appearance	No marked defect																											
		Capacitance Change	Within $\pm 5\%$																											
		Q	$200 + 10C^{*2}$ min. (10pF under) $275 + 5/2C^{*2}$ min. (10pF min. and 30pF under) 350 min. (30pF min.)																											
		I.R.	1000M Ω min.																											
<p>Set the capacitor for $500 \pm 24/-0$ hrs. at $40 \pm 2^\circ\text{C}$ in 90 to 95% relative humidity. Post-treatment: Capacitor should be stored for 1 to 2 hrs. at room condition.*¹</p>																														
16	Life	Appearance	No marked defect																											
		Capacitance Change	Within $\pm 3\%$																											
		Q	$200 + 10C^{*2}$ min. (10pF under) $275 + 5/2C^{*2}$ min. (10pF min. and 30pF under) 350 min. (30pF min.)																											
		I.R.	2000M Ω min.																											
<p>Apply 6.3kVp-p at the frequency in the Table for $1000 \pm 48/-0$ hrs. at $105 \pm 2^\circ\text{C}$ with a relative humidity of 50% max. (Charge/Discharge current $\leq 50\text{mA}$)</p> <p><Frequency></p> <table border="1" style="margin-left: auto; margin-right: auto;"> <thead> <tr style="background-color: #444; color: white;"> <th>Capacitance (pF)</th> <th>Frequency (kHz)</th> </tr> </thead> <tbody> <tr> <td>to 10</td> <td>100</td> </tr> <tr> <td>12 to 22</td> <td>45</td> </tr> <tr> <td>27 to 47</td> <td>33</td> </tr> </tbody> </table> <p>Post-treatment: Capacitor should be stored for 1 to 2 hrs. at room condition.*¹</p>				Capacitance (pF)	Frequency (kHz)	to 10	100	12 to 22	45	27 to 47	33																			
Capacitance (pF)	Frequency (kHz)																													
to 10	100																													
12 to 22	45																													
27 to 47	33																													

*¹ "Room condition" Temperature: 15 to 35°C, Relative humidity: 45 to 75%, Atmospheric pressure: 86 to 106kPa

*² "C" expresses nominal capacitance value (pF).

High Voltage Ceramic Capacitors Characteristics Data (Typical Example)

Capacitance - Temperature Characteristics



Capacitance - DC Bias Characteristics



High Voltage Ceramic Capacitors Packaging

Taping Specifications

- 15.0mm pitch / lead spacing 7.5mm taping
 Straight type
 (Lead Code: P3)



- 15.0mm pitch / lead spacing 7.5mm taping
 Vertical crimp type
 (Lead Code: N3)



- 30.0mm pitch / lead spacing 7.5mm taping
 Vertical crimp type
 (Lead Code: N7)



- 12.7mm pitch / lead spacing 5.0mm taping
 Straight type
 (Lead Code: P2)



- 12.7mm pitch / lead spacing 5.0mm taping
 Vertical crimp type
 (Lead Code: N2)

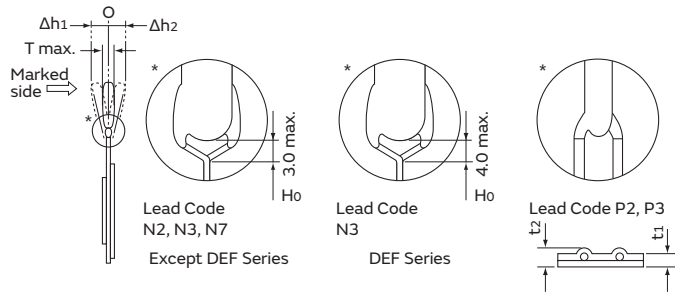
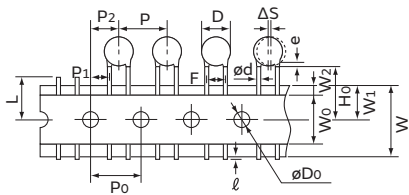

Item	Code	P3	N3	N7	P2	N2
Pitch of component	P	15.0±2.0		30.0±2.0	12.7±1.0	
Pitch of sprocket hole	P0	15.0±0.3		12.7±0.3		
Lead spacing	F	7.5±1.0		5.0 ^{+0.8} _{-0.2}		
Length from hole center to component center	P2	7.5±1.5		6.35±1.3		
Length from hole center to lead	P1	3.75±1.0		3.85±0.7		
Body diameter	D	See the individual product specifications.				
Deviation along tape, left or right	ΔS	0±2.0		0±1.0		
Carrier tape width	W	18.0±0.5				
Position of sprocket hole	W1	9.0±0.5				
Lead distance between reference and bottom planes	H	20.0 ^{+1.5} _{-1.0}	—		20.0 ^{+1.5} _{-1.0}	—
	H0	—	18.0 ^{+2.0} ₋₀		—	18.0 ^{+2.0} ₋₀
Protrusion length	l	+0.5 to -1.0				
Diameter of sprocket hole	øD0	4.0±0.1				
Lead diameter	ød	0.6±0.05				
Total tape thickness	t1	0.6±0.3				
Total thickness, tape and lead wire	t2	1.5 max.				
Body thickness	T	See the individual product specifications.				
Portion to cut in case of defect	L	11.0 ⁺⁰ _{-1.0}				
Hold down tape width	W0	11.5 min.				
Hold down tape position	W2	1.5±1.5				
Coating extension on lead	e	3.0 max. (Vertical crimp type: Up to the end of crimp)				
Deviation across tape, front	Δh1	2.0 max.			1.0 max.	
Deviation across tape, rear	Δh2					

(in : mm)

Continued on the following page. ↗

High Voltage Ceramic Capacitors Packaging

Continued from the preceding page. ↘

Packaging Styles



Minimum Quantity (Order in Sets Only)

[Bulk] (pcs./Bag)

	Body Dia. D (mm)	Lead Code A□, C□	Lead Code B□, D□, J□
		Long	Short
DEH Series DEA Series DEB Series	4.5 to 6	500	500
	7	250 *1	500
	8 to 11	250	500
	12	200	250
	13, 14	200	250
	15 to 18	100	200
DEC Series DEF Series	19 to 21	50	100
	7 to 9	250	500
	10, 11	100	–
	12 to 15	100	–

*1 Lead Spacing F=5.0mm (Code: A2): 500pcs.

[Taping] (pcs./Ammo Pack)

Lead Code	N2, P2	N3, P3	N7
DEH Series	1,500	900	500
DEA Series	1,500	900	500
DEB Series	1,500	900	500
DEF Series	–	900	–

High Voltage Ceramic Capacitors ⚠ Caution

⚠ Caution (Rating)

<DEH/DEA/DEB/DEC Series>

1. Operating Voltage

When DC-rated capacitors are to be used in AC or ripple current circuits, be sure to maintain the V_{p-p} value of the applied voltage or the V_{o-p} that contains DC bias within the rated voltage range.

When the voltage is applied to the circuit, starting or stopping may generate irregular voltage for a transit period because of resonance or switching. Be sure to use a capacitor with a rated voltage range that includes these irregular voltages.

When using the low-dissipation DEA (SL Char.) /DEC (SL Char.) /DEH (R Char.) series in a high- frequency and high-voltage circuit, be sure to read the instructions in item 4.

When DC-rated capacitors are to be used in input circuits from commercial power source (AC filter), be sure to use Safety Certified Capacitors because various regulations on withstand voltage or impulse withstand established for each type of equipment should be taken into consideration.

Voltage	DC Voltage	DC+AC Voltage	AC Voltage	Pulse Voltage (1)	Pulse Voltage (2)
Positional Measurement					

2. Operating Temperature and Self-generated Heat

Keep the surface temperature of a capacitor below the upper limit of its rated operating temperature range. Be sure to take into account the heat generated by the capacitor itself. When the capacitor is used in a high-frequency current, pulse current or similar current, it may self-generate heat due to dielectric loss. The frequency of the applied sine wave voltage should be less than 300kHz. The applied voltage load (*) should be such that the capacitor's self-generated heat is within 20°C in an atmospheric temperature of 25°C. When measuring, use a thermocouple of small thermal capacity-K of $\phi 0.1\text{mm}$ in conditions where the capacitor is not affected by radiant heat from other components or surrounding ambient fluctuations.

Excessive heat may lead to deterioration of the capacitor's characteristics and reliability.

(Never attempt to perform measurement with the cooling fan running. Otherwise, accurate measurement cannot be ensured.)

*Before using the low-dissipation DEA/DEC (SL Char.) /DEH series, be sure to read the instructions in item 4.

3. Fail-Safe

When the capacitor is broken, failure may result in a short circuit. Be sure to provide an appropriate fail-safe function like a fuse on your product if failure could follow an electric shock, fire or fume.

Continued on the following page. ↗

High Voltage Ceramic Capacitors ⚠Caution

Continued from the preceding page. ↘

4. Load Reduction and Self-generated Heat During Application of High-frequency and High-voltage

Due to the low self-heating characteristics of low-dissipation capacitors, the allowable electric power of these capacitors is generally much higher than that of B characteristic capacitors. However, if the self-heating temperature is 20°C under a high-frequency voltage whose peak-to-peak value equals the capacitor's rated voltage, the capacitor's power consumption may exceed its allowable electric power.

Therefore, when using the DEA/DEC (SL Char.) /DEH series in a high-frequency and high-voltage circuit with a frequency of 1kHz or higher, make sure that the Vp-p values including the DC bias, do not exceed the applied voltage value specified in Table 1. Also make sure that the self-heating temperature (the difference between the capacitor's surface temperature and the capacitor's ambient temperature) at an ambient temperature of 25°C does not exceed the value specified in Table 1.

As shown in Fig. 2, the self-heating temperature depends on the ambient temperature. Therefore, if you are not able to set the ambient temperature to approximately 25°C, please

contact our sales representatives or product engineers. We are offering free software, The Capacitor Selection Tool: by Voltage Form, which will assist you in selecting a suitable capacitor.

The software can be downloaded from Murata's Web site (http://www.murata.com/products/design_support/mmcsv/index.html).

By inputting capacitance values and applied voltage waveform of the specific capacitor series, this software will calculate the capacitor's power consumption and list suitable capacitors.

When the result of this software is different from the measurement result of the self-heating temperature on your side, please contact our sales representatives or product engineers.

FAILURE TO FOLLOW THE ABOVE CAUTIONS (ITEMS 1 TO 4) MAY RESULT, WORST CASE, IN A SHORT CIRCUIT AND CAUSE FUMING OR PARTIAL DISPERSION WHEN THE PRODUCT IS USED.

<Fig. 1> Relationship Between Applied Voltage and Self-heating Temperature (Allowable Self-heating Temp. at 25°C Ambient Temp.)

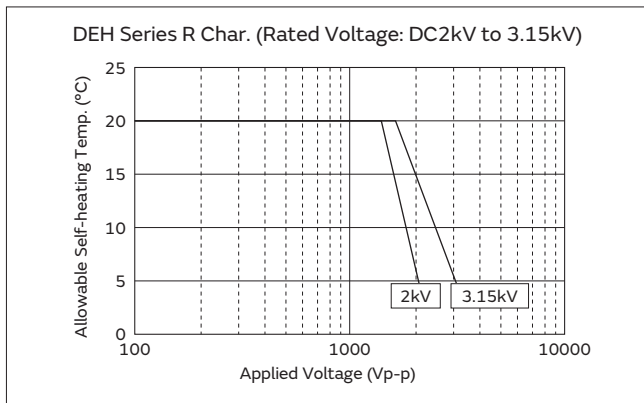

<Table 1> Allowable Conditions at High frequency

Series	Temp. Char.	DC Rated Voltage	Allowable Conditions at High-frequency *3		Capacitor's Ambient Temp. *2
			Applied Voltage (Max.)	Self-heating Temp. (25°C Ambient Temp.) *1	
DEH	R	2kV	1400Vp-p	20°C Max.	-25 to +85°C
			2000Vp-p	5°C Max.	
		3.15kV	1600Vp-p	20°C Max.	
			3150Vp-p	5°C Max.	
DEA	SL	2kV	2000Vp-p	5°C Max.	
		3.15kV	3150Vp-p	5°C Max.	
DEC	SL	6.3kV	6300Vp-p	5°C Max.	

*1 Fig. 1 shows the relationship between the applied voltage and the allowable self-heating temperature regarding 2 to 3.15kV rated voltage of the DEH series R characteristic.

*2 When the ambient temperature is 85 to 125°C, the applied voltage needs to be further reduced. If the DEA/DEH series needs to be used at an ambient temperature of 85 to 125°C, please contact our sales representatives or product engineers.

*3 Fig. 3 shows reference data on the allowable voltage - frequency characteristics for a sine wave voltage.

<Fig. 2> Dependence of Self-heating Temperature on Ambient Temperature

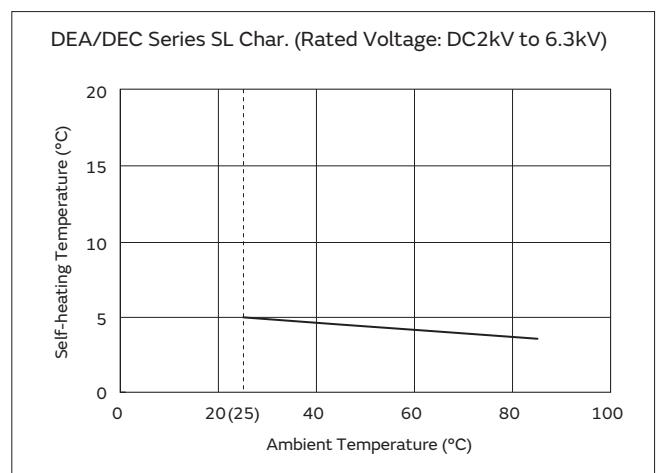
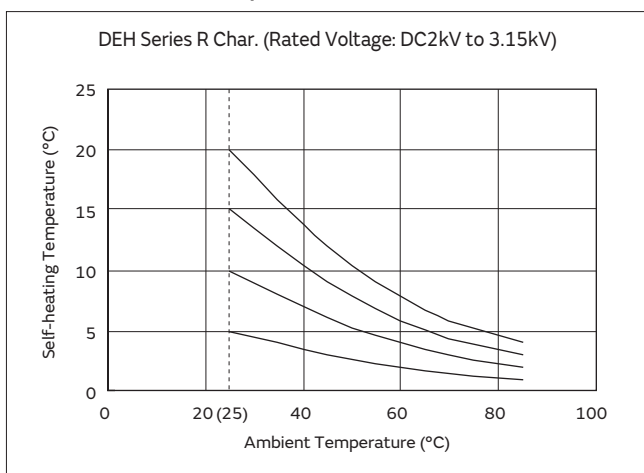

Continued on the following page. ↗

High Voltage Ceramic Capacitors ⚠Caution

Continued from the preceding page. ↘

<Fig. 3> Allowable Voltage (Sine Wave Voltage) - Frequency Characteristics (At Ambient Temperature of 85°C or less)

Because of the influence of harmonics, when the applied voltage is a rectangular wave or pulse wave voltage (instead of a sine wave voltage), the heat generated by the capacitor is higher than the value obtained by application of the sine wave with the same fundamental frequency.

Roughly calculated for reference, the allowable voltage for a rectangular wave or pulse wave corresponds approximately

to the allowable voltage for a sine wave whose fundamental frequency is twice as large as that of the rectangular wave or pulse wave. This allowable voltage, however, varies depending on the voltage and current waveforms.

Therefore, you are requested to make sure that the self-heating temperature is not higher than the value specified in Table 1.



High Voltage Ceramic Capacitors ⚠Caution

Continued from the preceding page. ↘

<DEF Series>

1. Operating Voltage

The frequency of the applied sine wave voltage should be less than 100kHz. The applied voltage should be less than the value shown in the figure below. For non-sine wave that includes a harmonic frequency, please contact our sales representatives or product engineers.



The temperature of the surface of the capacitor: below the upper limit of its rated operating temperature range (including self-heating).

The capacitor can be applied at a maximum of 6.3kVp-p at 100kHz when the lamp is turned on.

Voltage	AC Voltage
Positional Measurement	

2. Operating Temperature and Self-generated Heat

Keep the surface temperature of a capacitor below the upper limit of its rated operating temperature range. Be sure to take into account the heat generated by the capacitor itself. When the capacitor is used in a high-frequency current, pulse current or similar current, it may self-generate heat due to dielectric loss. Excessive heat may lead to deterioration of the capacitor's characteristics and reliability. (Never attempt to perform measurement with the cooling fan running. Otherwise, accurate measurement cannot be ensured.)

3. Fail-Safe

When the capacitor is broken, failure may result in a short circuit. Be sure to provide an appropriate fail-safe function like a fuse on your product if failure could result in an electric shock, fire or fume.

High Voltage Ceramic Capacitors ⚠Caution

⚠Caution (Storage and Operating Condition)

Operating and Storage Environment

The insulating coating of capacitors does not form a perfect seal; therefore, do not use or store capacitors in a corrosive atmosphere, especially where chloride gas, sulfide gas, acid, alkali, salt or the like are present. Also, avoid exposure to moisture. Before cleaning, bonding or molding this product, verify that these processes do not affect product quality by testing the performance of a cleaned, bonded or molded product in the intended equipment. Store the capacitors where the temperature and relative humidity do not exceed -10 to 40 degrees centigrade and 15 to 85%.

Use capacitors within 6 months after delivery.
Check the solderability after 6 months or more.

FAILURE TO FOLLOW THE ABOVE CAUTIONS MAY RESULT, WORST CASE, IN A SHORT CIRCUIT AND CAUSE FUMING OR PARTIAL DISPERSION WHEN THE PRODUCT IS USED.

⚠Caution (Soldering and Mounting)

1. Vibration and Impact

Do not expose a capacitor or its lead wires to excessive shock or vibration during use.

Excessive shock or vibration may cause fatigue destruction of lead wires mounted on the circuit board.

Please take measures to hold a capacitor on the circuit boards by adhesive, molding resin or another coating.

Please confirm there is no influence of holding measures on the product with the intended equipment.

2. Soldering

When soldering this product to a PCB/PWB, do not exceed the solder heat resistance specification of the capacitor. Subjecting this product to excessive heating could melt the internal junction solder and may result in thermal shocks that can crack the ceramic element.

Soldering the capacitor with a soldering iron should be performed in following conditions.

Temperature of iron-tip: 400 degrees C. max.

Soldering iron wattage: 50W max.

Soldering time: 3.5 sec. max.

3. Bonding, Resin Molding and Coating

For bonding, molding or coating this product, verify that these processes do not affect the quality of the capacitor by testing the performance of the bonded, molded or coated product in the intended equipment. When the amount of applications, dryness/hardening conditions of adhesives and molding resins containing organic solvents (ethyl acetate, methyl ethyl ketone, toluene, etc). are unsuitable, the outer coating resin of a capacitor is damaged by the organic solvents and it may result, worst case, in a short circuit.

The variation in thickness of adhesive, molding resin or coating may cause outer coating resin cracking and/or ceramic element cracking of a capacitor in a temperature cycling.

4. Treatment after Bonding, Resin Molding and Coating

When the outer coating is hot (over 100 degrees C.) after soldering, it becomes soft and fragile.

Therefore, please be careful not to give it mechanical stress.

FAILURE TO FOLLOW THE ABOVE CAUTIONS MAY RESULT, WORST CASE, IN A SHORT CIRCUIT AND CAUSE FUMING OR PARTIAL DISPERSION WHEN THE PRODUCT IS USED.

⚠Caution (Handling)

Vibration and Impact

Do not expose a capacitor or its lead wires to excessive shock or vibration during use.

Excessive shock or vibration may cause fatigue destruction of lead wires mounted on the circuit board.

Please take measures to hold a capacitor on the circuit boards by adhesive, molding resin or another coating.

Please confirm there is no influence of holding measures on the product with the intended equipment.

FAILURE TO FOLLOW THE ABOVE CAUTIONS MAY RESULT, WORST CASE, IN A SHORT CIRCUIT AND CAUSE FUMING OR PARTIAL DISPERSION WHEN THE PRODUCT IS USED.

High Voltage Ceramic Capacitors Notice

Notice (Soldering and Mounting)

Cleaning (ultrasonic cleaning)

To perform ultrasonic cleaning, observe the following conditions.

Rinse bath capacity: Output of 20 watts per liter or less.

Rinsing time: 5 min. maximum.

Do not vibrate the PCB/PWB directly.

Excessive ultrasonic cleaning may lead to fatigue destruction of the lead wires.

Notice (Rating)

Capacitance Change of Capacitors

1. DEA/DEC/DEF Series (Temp. Char. CH, SL)

Capacitance might change a little depending on the surrounding temperature or an applied voltage.

Please contact us if you intend to use this product in a strict time constant circuit.

2. DEB/DEC Series (Temp. Char. B, E, F)

Capacitors have an aging characteristic, whereby the capacitor continually decreases its capacitance slightly if the capacitor is left on for a long time. Moreover, capacitance might change greatly depending on the surrounding temperature or an applied voltage. Therefore, it is not likely to be suitable for use in a time constant circuit.

Please contact us if you need detailed information.

3. DEH Series

Capacitance might change greatly depending on the surrounding temperature or an applied voltage.

Therefore, it is not likely to be suitable for use in a time constant circuit. Please contact us if you need detailed information.

Safety Standard Certified Ceramic Capacitors for Automotive

Type KJ -Class X1, Y2- (For Automotive Use/AC Line Filter of PHEV/EV Charger)

Features

1. Capacitors designed for AC line filters for PHEV/EV.
2. Meet AEC-Q200
3. Heat cycle: 1000cycle (-55/+125 deg.)
4. Class X1/Y2 capacitors certified by UL/ENEC(VDE).
5. Rated Voltage: AC300V
6. Coated with flame-retardant epoxy resin (conforming to UL94V-0 standard).
7. Available product for RoHS Restriction (EU Directive 2002/95/EC).
8. Taping available for automatic insertion.

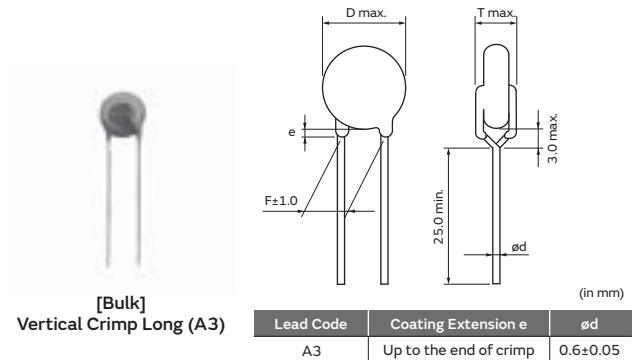

Applications

1. Ideal for use as Y capacitors for AC line filters and primary-secondary coupling on battery chargers for PHEV/EV.
2. Ideal for use as a filter capacitor for DC-DC converters for PHEV/EV and HEV.

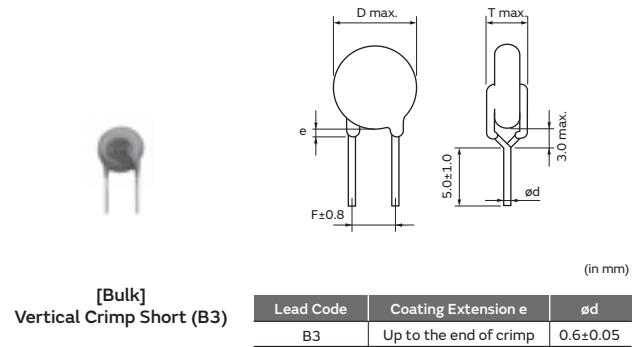

Standard Certification

	Standard No.	Certified No.	Rated Voltage
UL	UL 60384-14	E37921	AC300V(r.m.s.)
ENEC (VDE)	EN 60384-14	40031217	

Marking

Example	Item
	① Type Designation KJ
	② Nominal Capacitance (Marked with 3 figures)
	③ Capacitance Tolerance
	④ Company Name Code ©15 : Made in Thailand
	⑤ Manufactured Date Code Class Code X1Y2 Rated Voltage Mark 300~

Part Number	AC Rated Voltage	Temp. Char.	Capacitance	Body Dia. D	Lead Spacing F (mm)	Body Thickness T	Lead Package Long Bulk	Lead Package Short Bulk	Lead Package Taping
DE6B3KJ101K□□□	300Vac(r.m.s.)	B	100pF±10%	8.0mm max.	7.5	7.0mm max.	A3B	B3B	N3A
DE6B3KJ151K□□□	300Vac(r.m.s.)	B	150pF±10%	8.0mm max.	7.5	7.0mm max.	A3B	B3B	N3A
DE6B3KJ221K□□□	300Vac(r.m.s.)	B	220pF±10%	8.0mm max.	7.5	7.0mm max.	A3B	B3B	N3A
DE6B3KJ331K□□□	300Vac(r.m.s.)	B	330pF±10%	8.0mm max.	7.5	7.0mm max.	A3B	B3B	N3A
DE6B3KJ471K□□□	300Vac(r.m.s.)	B	470pF±10%	8.0mm max.	7.5	7.0mm max.	A3B	B3B	N3A
DE6B3KJ681K□□□	300Vac(r.m.s.)	B	680pF±10%	9.0mm max.	7.5	7.0mm max.	A3B	B3B	N3A
DE6E3KJ102M□□□	300Vac(r.m.s.)	E	1000pF±20%	7.0mm max.	7.5	7.0mm max.	A3B	B3B	N3A
DE6E3KJ152M□□□	300Vac(r.m.s.)	E	1500pF±20%	8.0mm max.	7.5	7.0mm max.	A3B	B3B	N3A
DE6E3KJ222M□□□	300Vac(r.m.s.)	E	2200pF±20%	9.0mm max.	7.5	7.0mm max.	A3B	B3B	N3A
DE6E3KJ332M□□□	300Vac(r.m.s.)	E	3300pF±20%	10.0mm max.	7.5	7.0mm max.	A3B	B3B	N3A
DE6E3KJ472M□□□	300Vac(r.m.s.)	E	4700pF±20%	12.0mm max.	7.5	7.0mm max.	A3B	B3B	N3A

Three blank columns are filled with the lead and packaging codes. Please refer to the 3 columns on the right for the appropriate code. Murata part numbers might be changed depending on lead code or any other changes. Therefore, please specify only the type name (KJ) and capacitance of products in the parts list when it is required for applying safety standard of electric equipment.

Type KJ Specifications and Test Methods

Operating Temperature Range: -40 to +125°C

No.	Item	Specifications	Test Method																		
1	Appearance and Dimensions	No visible defect, and dimensions are within specified range.	The capacitor should be visually inspected for evidence of defect. Dimensions should be measured with slide calipers.																		
2	Marking	To be easily legible	The capacitor should be visually inspected.																		
3	Capacitance	Within specified tolerance																			
4	Dissipation Factor (D.F.)	<table border="1"> <thead> <tr> <th>Char.</th> <th>Specifications</th> </tr> </thead> <tbody> <tr> <td>B, E</td> <td>D.F. ≤ 2.5%</td> </tr> </tbody> </table>	Char.	Specifications	B, E	D.F. ≤ 2.5%	The dissipation factor should be measured at 20°C with 1±0.1kHz and AC5V(r.m.s.) max.														
Char.	Specifications																				
B, E	D.F. ≤ 2.5%																				
5	Insulation Resistance (I.R.)	10000MΩ min.	The insulation resistance should be measured with DC500±50V within 60±5 sec. of charging. The voltage should be applied to the capacitor through a resistor of 1MΩ.																		
6	Between Lead Wires	No failure	The capacitor should not be damaged when the test voltages from Table 1 are applied between the lead wires for 60 sec. <Table 1> <table border="1"> <thead> <tr> <th>Type</th> <th>Test Voltage</th> </tr> </thead> <tbody> <tr> <td>KJ</td> <td>AC2600V(r.m.s.)</td> </tr> </tbody> </table>	Type	Test Voltage	KJ	AC2600V(r.m.s.)														
	Type	Test Voltage																			
KJ	AC2600V(r.m.s.)																				
Body Insulation	No failure	First, the terminals of the capacitor should be connected together. Then, as shown in the figure at right, a metal foil should be closely wrapped around the body of the capacitor to the distance of about 3 to 4mm from each terminal. Then, the capacitor should be inserted into a container filled with metal balls of about 1mm diameter. Finally, AC voltage from Table 2 is applied for 60 sec. between the capacitor lead wires and metal balls. <Table 2> <table border="1"> <thead> <tr> <th>Type</th> <th>Test Voltage</th> </tr> </thead> <tbody> <tr> <td>KJ</td> <td>AC2600V(r.m.s.)</td> </tr> </tbody> </table> 	Type	Test Voltage	KJ	AC2600V(r.m.s.)															
Type	Test Voltage																				
KJ	AC2600V(r.m.s.)																				
7	Temperature Characteristics	<table border="1"> <thead> <tr> <th>Char.</th> <th>Capacitance Change</th> </tr> </thead> <tbody> <tr> <td>B</td> <td>Within ±10%</td> </tr> <tr> <td>E</td> <td>Within $\pm\frac{20}{55}\%$</td> </tr> </tbody> </table> (Temp. range: -25 to +85°C)	Char.	Capacitance Change	B	Within ±10%	E	Within $\pm\frac{20}{55}\%$	The capacitance measurement should be made at each step specified in Table 3. <Table 3> <table border="1"> <thead> <tr> <th>Step</th> <th>Temperature (°C)</th> </tr> </thead> <tbody> <tr> <td>1</td> <td>20±2</td> </tr> <tr> <td>2</td> <td>-25±2</td> </tr> <tr> <td>3</td> <td>20±2</td> </tr> <tr> <td>4</td> <td>85±2</td> </tr> <tr> <td>5</td> <td>20±2</td> </tr> </tbody> </table> Pre-treatment: Capacitor should be stored at 125±3°C for 1 hr., then placed at room condition* for 24±2 hrs. before initial measurements.	Step	Temperature (°C)	1	20±2	2	-25±2	3	20±2	4	85±2	5	20±2
Char.	Capacitance Change																				
B	Within ±10%																				
E	Within $\pm\frac{20}{55}\%$																				
Step	Temperature (°C)																				
1	20±2																				
2	-25±2																				
3	20±2																				
4	85±2																				
5	20±2																				
8	Solderability	Lead wire should be soldered with uniform coating on the axial direction over 3/4 of the circumferential direction.	Should be placed into steam aging for 8 hrs.±15 min. After the steam aging, the lead wire of a capacitor should be dipped into an ethanol solution of 25% rosin and then into molten solder for 5+0/-0.5 sec. The depth of immersion is up to about 1.5 to 2.0mm from the root of lead wires. Temp. of solder: Lead Free Solder (Sn-3Ag-0.5Cu) 245±5°C H63 Eutectic Solder 235±5°C																		
9	Appearance	No marked defect	As shown in the figure, the lead wires should be immersed in solder of 260±5°C up to 1.5 to 2.0mm from the root of terminal for 10±1 sec. Pre-treatment: Capacitor should be stored at 125±3°C for 1 hr., then placed at room condition* for 24±2 hrs. before initial measurements. Post-treatment: Capacitor should be stored for 1 to 2 hrs. at room condition.* 																		
	Capacitance Change	Within ±10%																			
	I.R.	1000MΩ min.																			
	Dielectric Strength	Per Item 6																			

* "Room condition" Temperature: 15 to 35°C, Relative humidity: 45 to 75%, Atmospheric pressure: 86 to 106kPa

Continued on the following page. ↗

Type KJ Specifications and Test Methods

Continued from the preceding page. ↘

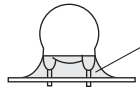
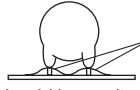
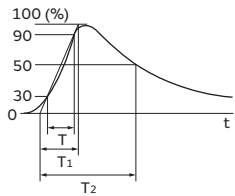
No.	Item	Specifications	Test Method							
10	Vibration	Appearance	Solder the capacitor and gum up the body to the test jig (glass epoxy board) by resin (adhesive).  Resin (Adhesive) The capacitor should be firmly soldered to the supporting lead wire, 1.5mm in total amplitude, with about a 20 minutes rate of vibration change from 10Hz to 2000Hz and back to 10Hz. This motion should be applied 12 times in each of 3 mutually perpendicular directions (total of 36 times). The acceleration is 5g max.							
		Capacitance		Within the specified tolerance						
		D.F.		<table border="1"> <thead> <tr> <th>Char.</th> <th>Specifications</th> </tr> </thead> <tbody> <tr> <td>B, E</td> <td>D.F. ≤ 2.5%</td> </tr> </tbody> </table>	Char.	Specifications	B, E	D.F. ≤ 2.5%		
Char.	Specifications									
B, E	D.F. ≤ 2.5%									
11	Mechanical Shock	Appearance	Solder the capacitor and gum up the body to the test jig (glass epoxy board) by resin (adhesive).  Resin (Adhesive) Three shocks in each direction should be applied along 3 mutually perpendicular axes to and from of the test specimen (18 shocks). The specified test pulse should be half-sine and should have a duration: 0.5ms, peak value: 100g and velocity change: 4.7m/s.							
		Capacitance		Within the specified tolerance						
		D.F.		<table border="1"> <thead> <tr> <th>Char.</th> <th>Specifications</th> </tr> </thead> <tbody> <tr> <td>B, E</td> <td>D.F. ≤ 5.0%</td> </tr> </tbody> </table>	Char.	Specifications	B, E	D.F. ≤ 5.0%		
		Char.		Specifications						
B, E	D.F. ≤ 5.0%									
I.R.	10000MΩ min.									
12	Humidity (Under Steady State)	Appearance	Set the capacitor for 1000±12 hrs. at 85±3°C in 80 to 85% relative humidity. Pre-treatment: Capacitor should be stored at 125±3°C for 1hr., then placed at room condition* for 24±2 hrs. before initial measurements. Post-treatment: Capacitor should be stored for 1 to 2 hrs. at room condition.*							
		Capacitance Change		<table border="1"> <thead> <tr> <th>Char.</th> <th>Capacitance Change</th> </tr> </thead> <tbody> <tr> <td>B</td> <td>Within ±10%</td> </tr> <tr> <td>E</td> <td>Within ±15%</td> </tr> </tbody> </table>	Char.	Capacitance Change	B	Within ±10%	E	Within ±15%
		Char.		Capacitance Change						
		B		Within ±10%						
		E		Within ±15%						
D.F.	<table border="1"> <thead> <tr> <th>Char.</th> <th>Specifications</th> </tr> </thead> <tbody> <tr> <td>B, E</td> <td>D.F. ≤ 5.0%</td> </tr> </tbody> </table>	Char.	Specifications	B, E	D.F. ≤ 5.0%					
Char.	Specifications									
B, E	D.F. ≤ 5.0%									
I.R.	3000MΩ min.									
Dielectric Strength	Per Item 6									
13	Humidity Loading	Appearance	Apply the rated voltage for 1000±12 hrs. at 85±3°C in 80 to 85% relative humidity. Pre-treatment: Capacitor should be stored at 125±3°C for 1hr., then placed at room condition* for 24±2 hrs. before initial measurements. Post-treatment: Capacitor should be stored for 1 to 2 hrs. at room condition.*							
		Capacitance Change		<table border="1"> <thead> <tr> <th>Char.</th> <th>Capacitance Change</th> </tr> </thead> <tbody> <tr> <td>B</td> <td>Within ±10%</td> </tr> <tr> <td>E</td> <td>Within ±15%</td> </tr> </tbody> </table>	Char.	Capacitance Change	B	Within ±10%	E	Within ±15%
		Char.		Capacitance Change						
		B		Within ±10%						
E	Within ±15%									
D.F.	<table border="1"> <thead> <tr> <th>Char.</th> <th>Specifications</th> </tr> </thead> <tbody> <tr> <td>B, E</td> <td>D.F. ≤ 5.0%</td> </tr> </tbody> </table>	Char.	Specifications	B, E	D.F. ≤ 5.0%					
Char.	Specifications									
B, E	D.F. ≤ 5.0%									
I.R.	3000MΩ min.									
14	Life	Appearance	Impulse Voltage Each individual capacitor should be subjected to a 5kV impulses for three times. Then the capacitors are applied to life test.  Front time (T ₁) = 1.2μs = 1.67T Time to half-value (T ₂) = 50μs							
		Capacitance Change		Within ±20%						
		I.R.		3000MΩ min.						
	Dielectric Strength	Per Item 6	Apply a voltage from Table 4 for 1000 hrs. at 125+2/-0°C, and relative humidity of 50% max. <Table 4> <table border="1"> <thead> <tr> <th>Applied Voltage</th> </tr> </thead> <tbody> <tr> <td>AC510V(r.m.s.), except that once each hour the voltage is increased to AC1000V(r.m.s.) for 0.1 sec.</td> </tr> </tbody> </table> Pre-treatment: Capacitor should be stored at 125±3°C for 1hr., then placed at room condition* for 24±2 hrs. before initial measurements. Post-treatment: Capacitor should be stored for 1 to 2 hrs. at room condition.*	Applied Voltage	AC510V(r.m.s.), except that once each hour the voltage is increased to AC1000V(r.m.s.) for 0.1 sec.					
Applied Voltage										
AC510V(r.m.s.), except that once each hour the voltage is increased to AC1000V(r.m.s.) for 0.1 sec.										

* "Room condition" Temperature: 15 to 35°C, Relative humidity: 45 to 75%, Atmospheric pressure: 86 to 106kPa

Continued on the following page. ↗

Type KJ Specifications and Test Methods

Continued from the preceding page. ↘

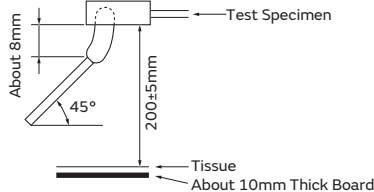
No.	Item	Specifications	Test Method															
15	Robustness of Terminations	Tensile	As shown in the figure at right, fix the body of the capacitor and apply a tensile weight gradually to each lead wire in the radial direction of the capacitor up to 10N and keep it for 10±1 sec. 															
	Bending	Lead wire should not be cut off. Capacitor should not be broken.		Each lead wire should be subjected to 5N of weight and bent 90° at the point of egress, in one direction, then returned to its original position and bent 90° in the opposite direction at the rate of one bend in 2 to 3 sec.														
16	Active Flammability	The cheesecloth should not catch on fire.	The capacitor should be individually wrapped in at least one, but not more than two, complete layers of cheesecloth. The capacitor should be subjected to 20 discharges. The interval between successive discharges should be 5 sec. The UAC should be maintained for 2 min. after the last discharge. <div style="text-align: center;">  </div> <p> C1,2 : 1μF±10% C3 : 0.033μF±5% 10kV L1 to 4 : 1.5mH±20% 16A Rod core choke Ct : 3μF±5% 10kV R : 100Ω±2% Cx : Capacitor under test UAC : UR±5% F : Fuse, Rated 10A UR : Rated Voltage Ut : Voltage applied to Ct </p> <div style="text-align: center;">  </div>															
17	Passive Flammability	The burning time should not exceed 30 sec. The tissue paper should not ignite.	The capacitor under test should be held in the flame in the position that best promotes burning. Each specimen should only be exposed once to the flame. Time of exposure to flame: 30 sec. <p style="margin-left: 40px;"> Length of flame: 12±1mm Gas burner : Length 35mm min. Inside Dia. 0.5±0.1mm Outside Dia. 0.9mm max. Gas : Butane gas Purity 95% min. </p> <div style="text-align: center;">  </div>															
18	Temperature Cycle	Appearance	No marked defect															
		Capacitance Change	<table border="1" style="margin-left: auto; margin-right: auto; border-collapse: collapse;"> <thead> <tr style="background-color: #cccccc;"> <th style="width: 10%;">Char.</th> <th style="width: 90%;">Capacitance Change</th> </tr> </thead> <tbody> <tr> <td style="text-align: center;">B</td> <td style="text-align: center;">Within ±10%</td> </tr> <tr> <td style="text-align: center;">E</td> <td style="text-align: center;">Within ±20%</td> </tr> </tbody> </table>	Char.	Capacitance Change	B	Within ±10%	E	Within ±20%									
		Char.	Capacitance Change															
		B	Within ±10%															
		E	Within ±20%															
D.F.	<table border="1" style="margin-left: auto; margin-right: auto; border-collapse: collapse;"> <thead> <tr style="background-color: #cccccc;"> <th style="width: 10%;">Char.</th> <th style="width: 90%;">Specifications</th> </tr> </thead> <tbody> <tr> <td style="text-align: center;">B, E</td> <td style="text-align: center;">D.F. ≤5.0%</td> </tr> </tbody> </table>	Char.	Specifications	B, E	D.F. ≤5.0%													
Char.	Specifications																	
B, E	D.F. ≤5.0%																	
I.R.	3000MΩ min.																	
Dielectric Strength	Per Item 6																	
			The capacitor should be subjected to 1000 temperature cycles. <table border="1" style="margin-left: auto; margin-right: auto; border-collapse: collapse;"> <thead> <tr style="background-color: #cccccc;"> <th style="width: 10%;">Step</th> <th style="width: 60%;">Temperature (°C)</th> <th style="width: 30%;">Time (min)</th> </tr> </thead> <tbody> <tr> <td style="text-align: center;">1</td> <td style="text-align: center;">-55+0/-3</td> <td style="text-align: center;">30</td> </tr> <tr> <td style="text-align: center;">2</td> <td style="text-align: center;">Room temp.</td> <td style="text-align: center;">3</td> </tr> <tr> <td style="text-align: center;">3</td> <td style="text-align: center;">125+3/-0</td> <td style="text-align: center;">30</td> </tr> <tr> <td style="text-align: center;">4</td> <td style="text-align: center;">Room temp.</td> <td style="text-align: center;">3</td> </tr> </tbody> </table> <p style="text-align: right;">Cycle time: 1000 cycles</p> <p>Pre-treatment: Capacitor should be stored at 125±3°C for 1 hr., then placed at room condition* for 24±2 hrs.</p> <p>Post-treatment: Capacitor should be stored for 24±2 hrs. at room condition.*</p>	Step	Temperature (°C)	Time (min)	1	-55+0/-3	30	2	Room temp.	3	3	125+3/-0	30	4	Room temp.	3
Step	Temperature (°C)	Time (min)																
1	-55+0/-3	30																
2	Room temp.	3																
3	125+3/-0	30																
4	Room temp.	3																

* "Room condition" Temperature: 15 to 35°C, Relative humidity: 45 to 75%, Atmospheric pressure: 86 to 106kPa

Continued on the following page. ↗

Type KJ Specifications and Test Methods

Continued from the preceding page. ↘

No.	Item	Specifications	Test Method									
19	High Temperature Exposure (Storage)	Capacitance Change Within ±20%	Set the capacitor for 1000±12 hrs. at 150±3°C. Pre-treatment: Capacitor should be stored at 125±3°C for 1 hr., then placed at room condition* for 24±2 hrs. Post-treatment: Capacitor should be stored for 24±2 hrs. at room condition.*									
	D.F.	<table border="1"> <thead> <tr> <th>Char.</th> <th>Specifications</th> </tr> </thead> <tbody> <tr> <td>B, E</td> <td>D.F. ≤5.0%</td> </tr> </tbody> </table>		Char.	Specifications	B, E	D.F. ≤5.0%					
	Char.	Specifications										
B, E	D.F. ≤5.0%											
I.R.	1000MΩ min.											
20	Thermal Shock	Appearance No marked defect except color change of outer coating.	The capacitor should be subjected to 300 cycles. <table border="1"> <thead> <tr> <th>Step</th> <th>Temperature (°C)</th> <th>Time (min)</th> </tr> </thead> <tbody> <tr> <td>1</td> <td>-55+0/-3</td> <td>30</td> </tr> <tr> <td>2</td> <td>125+3/-0</td> <td>30</td> </tr> </tbody> </table> Pre-treatment: Capacitor should be stored at 125±3°C for 1 hr., then placed at room condition* for 24±2 hrs. Post-treatment: Capacitor should be stored for 24±2 hrs. at room condition.*	Step	Temperature (°C)	Time (min)	1	-55+0/-3	30	2	125+3/-0	30
	Step	Temperature (°C)		Time (min)								
	1	-55+0/-3		30								
	2	125+3/-0		30								
Capacitance Change	<table border="1"> <thead> <tr> <th>Char.</th> <th>Capacitance Change</th> </tr> </thead> <tbody> <tr> <td>B</td> <td>Within ±10%</td> </tr> <tr> <td>E</td> <td>Within ±20%</td> </tr> </tbody> </table>	Char.	Capacitance Change	B	Within ±10%	E	Within ±20%					
Char.	Capacitance Change											
B	Within ±10%											
E	Within ±20%											
D.F.	<table border="1"> <thead> <tr> <th>Char.</th> <th>Specifications</th> </tr> </thead> <tbody> <tr> <td>B, E</td> <td>D.F. ≤5.0%</td> </tr> </tbody> </table>	Char.	Specifications	B, E	D.F. ≤5.0%							
Char.	Specifications											
B, E	D.F. ≤5.0%											
I.R.	3000MΩ min.											
21	Resistance to Solvents	Appearance No marked defect	Per MIL-STD-202 Method 215 Solvent 1: 1 part (by volume) of isopropyl alcohol 3 parts (by volume) of mineral spirits Solvent 2: Terpene defluxer Solvent 3: 42 parts (by volume) of water 1 part (by volume) of propylene glycol monomethyl ether 1 part (by volume) of monoethanolamine									
	Capacitance Change	<table border="1"> <thead> <tr> <th>Char.</th> <th>Capacitance Change</th> </tr> </thead> <tbody> <tr> <td>B</td> <td>Within ±10%</td> </tr> <tr> <td>E</td> <td>Within ±20%</td> </tr> </tbody> </table>		Char.	Capacitance Change	B	Within ±10%	E	Within ±20%			
	Char.	Capacitance Change										
	B	Within ±10%										
E	Within ±20%											
D.F.	<table border="1"> <thead> <tr> <th>Char.</th> <th>Specifications</th> </tr> </thead> <tbody> <tr> <td>B, E</td> <td>D.F. ≤5.0%</td> </tr> </tbody> </table>	Char.	Specifications	B, E	D.F. ≤5.0%							
Char.	Specifications											
B, E	D.F. ≤5.0%											
I.R.	3000MΩ min.											
22	Biased Humidity	Appearance No marked defect	Apply the rated voltage and DC1.3+0.2/-0V (add 6.8kΩ resistor) at 85±3°C and 80 to 85% humidity for 1000±12 hrs. Pre-treatment: Capacitor should be stored at 125±3°C for 1hr., then placed at room condition* for 24±2 hrs. Post-treatment: Capacitor should be stored for 24±2 hrs. at room condition.*									
	Capacitance Change	<table border="1"> <thead> <tr> <th>Char.</th> <th>Capacitance Change</th> </tr> </thead> <tbody> <tr> <td>B</td> <td>Within ±10%</td> </tr> <tr> <td>E</td> <td>Within ±15%</td> </tr> </tbody> </table>		Char.	Capacitance Change	B	Within ±10%	E	Within ±15%			
	Char.	Capacitance Change										
	B	Within ±10%										
E	Within ±15%											
D.F.	<table border="1"> <thead> <tr> <th>Char.</th> <th>Specifications</th> </tr> </thead> <tbody> <tr> <td>B, E</td> <td>D.F. ≤5.0%</td> </tr> </tbody> </table>	Char.	Specifications	B, E	D.F. ≤5.0%							
Char.	Specifications											
B, E	D.F. ≤5.0%											
I.R.	3000MΩ min.											
23	Moisture Resistance	Appearance No marked defect	Apply 24 hrs. of heat (25 to 65°C) and humidity (80 to 98%) treatment shown below, 10 consecutive times. Pre-treatment: Capacitor should be stored at 125±3°C for 1 hr., then placed at room condition* for 24±2 hrs. Post-treatment: Capacitor should be stored for 24±2 hrs. at room condition.*									
	Capacitance Change	<table border="1"> <thead> <tr> <th>Char.</th> <th>Capacitance Change</th> </tr> </thead> <tbody> <tr> <td>B</td> <td>Within ±10%</td> </tr> <tr> <td>E</td> <td>Within ±20%</td> </tr> </tbody> </table>		Char.	Capacitance Change	B	Within ±10%	E	Within ±20%			
	Char.	Capacitance Change										
	B	Within ±10%										
E	Within ±20%											
D.F.	<table border="1"> <thead> <tr> <th>Char.</th> <th>Specifications</th> </tr> </thead> <tbody> <tr> <td>B, E</td> <td>D.F. ≤5.0%</td> </tr> </tbody> </table>	Char.	Specifications	B, E	D.F. ≤5.0%							
Char.	Specifications											
B, E	D.F. ≤5.0%											
I.R.	3000MΩ min.											



* "Room condition" Temperature: 15 to 35°C, Relative humidity: 45 to 75%, Atmospheric pressure: 86 to 106kPa

Safety Certified Ceramic Capacitors for Automotive Characteristics Data (Typical Example)

Capacitance - Temperature Characteristics

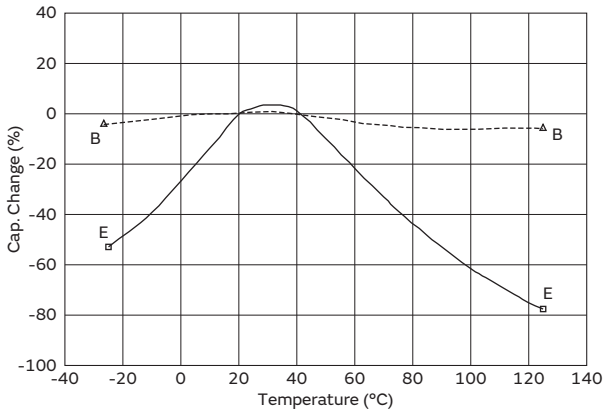

Insertion Loss - Frequency Characteristics

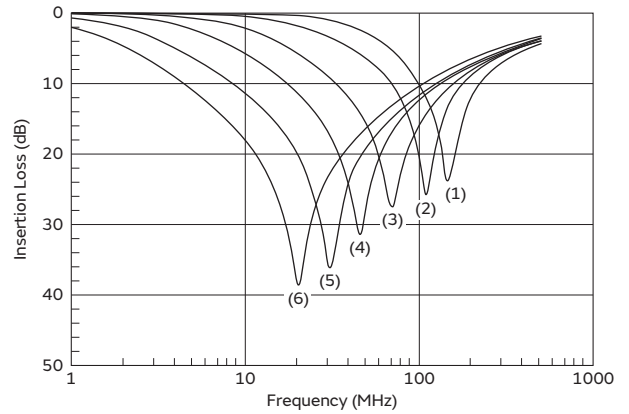

Type KJ
 Signal power: 1mW
 AC240V(r.m.s.) / 60Hz is applied on the capacitor.

(1) 100pF
 (2) 220pF
 (3) 470pF
 (4) 1000pF
 (5) 2200pF
 (6) 4700pF

Leakage Current Characteristics

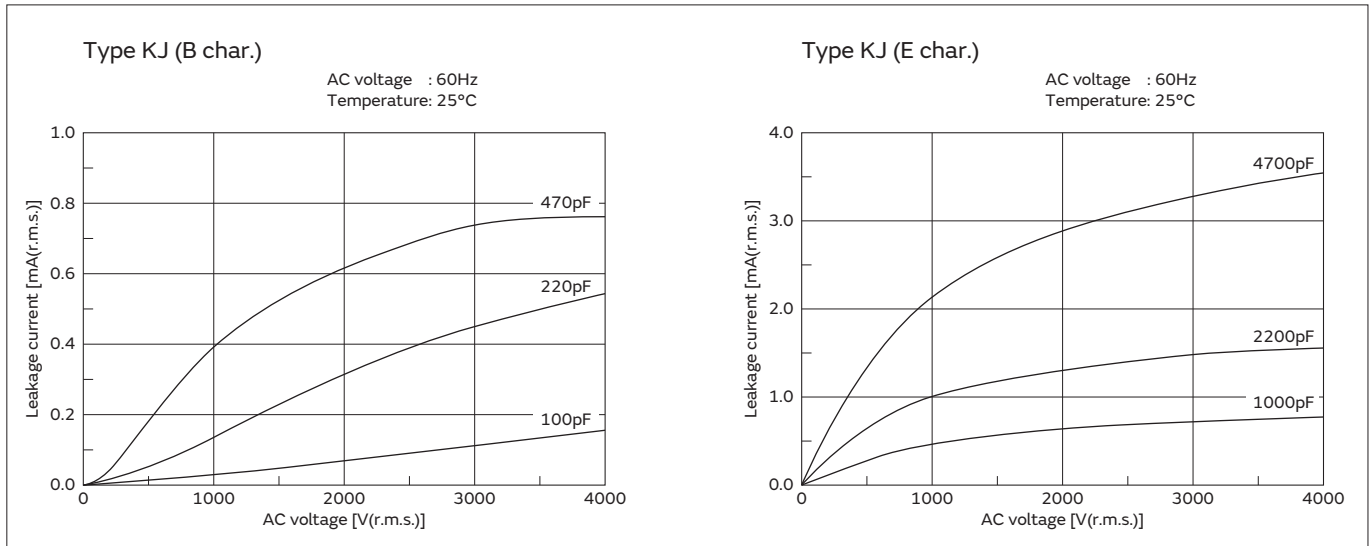

Safety Certified Ceramic Capacitors for Automotive Packaging

Taping Specifications

- 15mm pitch / lead spacing 7.5mm taping
 Vertical crimp type
 (Lead Code: N3)



Item	Code	N3
Pitch of component	P	15.0±2.0
Pitch of sprocket hole	P ₀	15.0±0.3
Lead spacing	F	7.5±1.0
Length from hole center to component center	P ₂	7.5±1.5
Length from hole center to lead	P ₁	3.75±1.0
Body diameter	D	See the individual product specifications.
Deviation along tape, left or right	ΔS	0±2.0
Carrier tape width	W	18.0±0.5
Position of sprocket hole	W ₁	9.0±0.5
Lead distance between reference and bottom planes	H ₀	18.0 ^{+2.0} ₀
Protrusion length	ℓ	+0.5 to -1.0
Diameter of sprocket hole	øD ₀	4.0±0.1
Lead diameter	ød	0.6±0.05
Total tape thickness	t ₁	0.6±0.3
Total thickness, tape and lead wire	t ₂	1.5 max.
Body thickness	T	7.0 max.
Portion to cut in case of defect	L	11.0 ⁰ _{-1.0}
Hold down tape width	W ₀	11.5 min.
Hold down tape position	W ₂	1.5±1.5
Coating extension on lead	e	Up to the end of crimp
Deviation across tape, front	Δh ₁	2.0 max.
Deviation across tape, rear	Δh ₂	

(in mm)

Packaging Styles

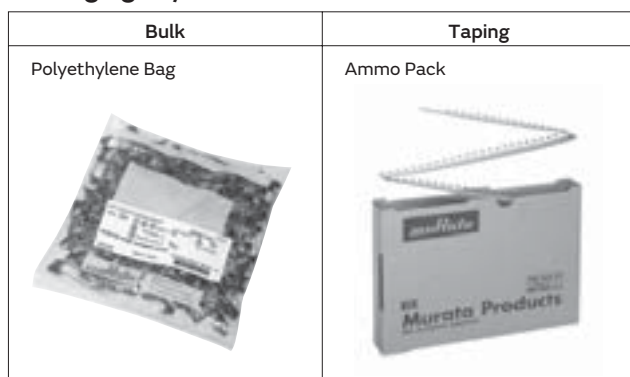

Minimum Quantity (Order in Sets Only)

Body Dia. D (mm)	[Bulk] (pcs./Bag)	
	Lead Code A3 Long	Lead Code B3 Short
7 to 10	250	500
12	200	250

[Taping]

Lead Code: N3
 700pcs./Ammo Pack

Safety Certified Ceramic Capacitors for Automotive ⚠Caution

⚠Caution (Rating)

1. Operating Voltage

When DC-rated capacitors are to be used in AC or ripple current circuits, be sure to maintain the V_{p-p} value of the applied voltage or the V_{o-p} that contains DC bias within the rated voltage range.

When the voltage is applied to the circuit, starting or stopping may generate irregular voltage for a transit period because of resonance or switching. Be sure to use a capacitor with a rated voltage range that includes these irregular voltages.

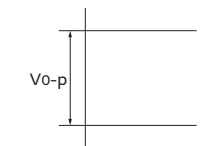
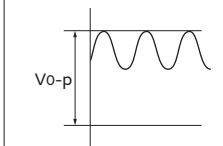
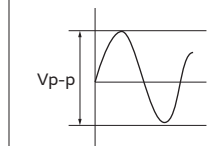
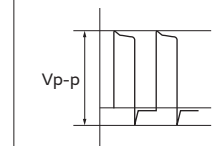
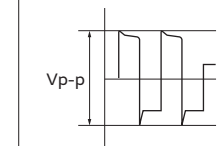
Voltage	DC Voltage	DC+AC Voltage	AC Voltage	Pulse Voltage (1)	Pulse Voltage (2)
Positional Measurement					

2. Operating Temperature and Self-generated Heat

Keep the surface temperature of a capacitor below the upper limit of its rated operating temperature range. Be sure to take into account the heat generated by the capacitor itself. When the capacitor is used in a high-frequency current, pulse current or similar current, it may have self-generated heat due to dielectric loss. Applied voltage load should be such that self-generated heat is within 20°C under the condition where the capacitor is subjected to an atmospheric temperature of 25°C. When measuring, use a thermocouple of small thermal capacity-K of $\phi 0.1\text{mm}$ under conditions where the capacitor is not affected by radiant heat from other components or wind from surroundings. Excessive heat may lead to deterioration of the capacitor's characteristics and reliability. (Never attempt to perform measurement with the cooling fan running. Otherwise, accurate measurement cannot be ensured.)

3. Test Condition for Withstanding Voltage

(1) Test Equipment

Test equipment for AC withstanding voltage should be used with the performance of the wave similar to 50/60Hz sine wave.

If the distorted sine wave or overload exceeding the specified voltage value is applied, a defect may be caused.

Continued on the following page. ↗

Safety Certified Ceramic Capacitors for Automotive ⚠Caution

Continued from the preceding page. ↘

(2) Voltage Applied Method

When the withstanding voltage is applied, the capacitor's lead or terminal should be firmly connected to the output of the withstanding voltage test equipment, and then the voltage should be raised from near zero to the test voltage.

If the test voltage without the raise from near zero voltage would be applied directly to capacitor, test voltage should be applied with the zero cross.* At the end of the test time, the test voltage should be reduced to near zero, and then capacitor's lead or terminal should be taken off the output of the withstanding voltage test equipment.

If the test voltage without the raise from near zero voltage would be applied directly to capacitor, the surge voltage may rise, and therefore, a defect may be caused.

*ZERO CROSS is the point where voltage sine wave passes 0V. See the figure at right.

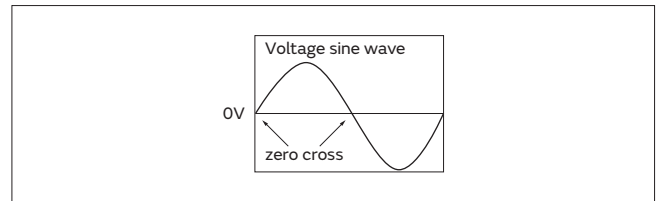

4. Fail-Safe

When the capacitor is broken, failure may result in a short circuit. Be sure to provide an appropriate fail-safe function like a fuse on your product if failure could result in an electric shock, fire or fuming.

FAILURE TO FOLLOW THE ABOVE CAUTIONS MAY RESULT, WORST CASE, IN A SHORT CIRCUIT AND CAUSE FUMING OR PARTIAL DISPERSION WHEN THE PRODUCT IS USED.

Safety Certified Ceramic Capacitors for Automotive ⚠️Caution

⚠️Caution (Storage and Operating Condition)

Operating and Storage Environment

The insulating coating of capacitors does not form a perfect seal; therefore, do not use or store capacitors in a corrosive atmosphere, especially where chloride gas, sulfide gas, acid, alkali, salt or the like are present. Also, avoid exposure to moisture. Before cleaning, bonding, or molding this product, verify that these processes do not affect product quality by testing the performance of a cleaned, bonded or molded product in the intended equipment. Store the capacitors where the temperature and relative humidity do not exceed -10 to 40 degrees centigrade and 15 to 85%.

Use capacitors within 6 months after delivery.
Check the solderability after 6 months or more.

FAILURE TO FOLLOW THE ABOVE CAUTIONS MAY RESULT, WORST CASE, IN A SHORT CIRCUIT AND CAUSE FUMING OR PARTIAL DISPERSION WHEN THE PRODUCT IS USED.

⚠️Caution (Soldering and Mounting)

1. Vibration and Impact

Do not expose a capacitor or its lead wires to excessive shock or vibration during use. Excessive shock or vibration may cause fatigue destruction of lead wires mounted on the circuit board. Please take measures to hold a capacitor on the circuit boards by adhesive, molding resin or another coating. Please confirm there is no influence of holding measures on the product with the intended equipment.

2. Soldering

When soldering this product to a PCB/PWB, do not exceed the solder heat resistance specifications of the capacitor. Subjecting this product to excessive heating could melt the internal junction solder and may result in thermal shocks that can crack the ceramic element. Soldering the capacitor with a soldering iron should be performed in the following conditions.
Temperature of iron-tip: 400 degrees C. max.
Soldering iron wattage: 50W max.
Soldering time: 3.5 sec. max.

3. Bonding, Resin Molding and Coating

For bonding, molding or coating this product, verify that these processes do not affect the quality of the capacitor by testing the performance of the bonded, molded or coated product in the intended equipment. When the amount of applications, dryness/hardening conditions of adhesives and molding resins containing organic solvents (ethyl acetate, methyl ethyl ketone, toluene, etc). are unsuitable, the outer coating resin of a capacitor is damaged by the organic solvents and it may result, worst case, in a short circuit. The variation in thickness of adhesive, molding resin or coating may cause outer coating resin cracking and/or ceramic element cracking of a capacitor in a temperature cycling.

4. Treatment after Bonding, Resin Molding and Coating

When the outer coating is hot (over 100 degrees C.) after soldering, it becomes soft and fragile. Therefore, please be careful not to give it mechanical stress.

FAILURE TO FOLLOW THE ABOVE CAUTIONS MAY RESULT, WORST CASE, IN A SHORT CIRCUIT AND CAUSE FUMING OR PARTIAL DISPERSION WHEN THE PRODUCT IS USED.

⚠️Caution (Handling)

Vibration and Impact

Do not expose a capacitor or its lead wires to excessive shock or vibration during use. Excessive shock or vibration may cause fatigue destruction of lead wires mounted on the circuit board. Please take measures to hold a capacitor on the circuit boards by adhesive, molding resin or another coating.

Please confirm there is no influence of holding measures on the product with the intended equipment.

FAILURE TO FOLLOW THE ABOVE CAUTIONS MAY RESULT, WORST CASE, IN A SHORT CIRCUIT AND CAUSE FUMING OR PARTIAL DISPERSION WHEN THE PRODUCT IS USED.

Safety Certified Ceramic Capacitors for Automotive Notice

Notice (Soldering and Mounting)

Cleaning (ultrasonic cleaning)

To perform ultrasonic cleaning, observe the following conditions.

Rinse bath capacity: Output of 20 watts per liter or less.

Rinsing time: 5 min. maximum.

Do not vibrate the PCB/PWB directly.

Excessive ultrasonic cleaning may lead to fatigue destruction of the lead wires.

Notice (Rating)

1. Capacitance Change of Capacitors

Capacitors have an aging characteristic, whereby the capacitor continually decreases its capacitance slightly if the capacitor is left on for a long time. Moreover, capacitance might change greatly depending on the surrounding temperature or an applied voltage. Therefore, it is not likely to be suitable for use in a constant time circuit.

Please contact us if you need detailed information.

2. Performance Check by Equipment

Before using a capacitor, check that there is no problem in the equipment's performance and the specifications.

Generally speaking, CLASS 2 ceramic capacitors have voltage dependence characteristics and temperature dependence characteristics in capacitance. Therefore, the capacitance value may change depending on the operating condition in the equipment. Therefore, be sure to confirm the apparatus performance of receiving influence in the capacitance value change of a capacitor, such as leakage current and noise suppression characteristic.

Moreover, check the surge-proof ability of a capacitor in the equipment, if needed, because the surge voltage may exceed specific value by the inductance of the circuit.

Safety Certified Ceramic Capacitors/High Voltage Ceramic Capacitors ISO9000 Certifications

Manufacturing plants that produce the products in this catalog have obtained the ISO9000 quality system certificate.

Plant	Applied Standard
Izumo Murata Manufacturing Co., Ltd.	ISO9001
Murata Electronics (Thailand), Ltd.	ISO9001
Taiwan Murata Electronics Co., Ltd.	ISO9001

Global Locations

For details please visit www.murata.com



⚠ Note

1 Export Control

For customers outside Japan:

No Murata products should be used or sold, through any channels, for use in the design, development, production, utilization, maintenance or operation of, or otherwise contribution to (1) any weapons (Weapons of Mass Destruction [nuclear, chemical or biological weapons or missiles] or conventional weapons) or (2) goods or systems specially designed or intended for military end-use or utilization by military end-users.

For customers in Japan:

For products which are controlled items subject to the "Foreign Exchange and Foreign Trade Law" of Japan, the export license specified by the law is required for export.

2 Please contact our sales representatives or product engineers before using the products in this catalog for the applications listed below, which require especially high reliability for the prevention of defects which might directly damage a third party's life, body or property, or when one of our products is intended for use in applications other than those specified in this catalog.

- ① Aircraft equipment
- ② Aerospace equipment
- ③ Undersea equipment
- ④ Power plant equipment
- ⑤ Medical equipment
- ⑥ Transportation equipment (vehicles, trains, ships, etc.)
- ⑦ Traffic signal equipment
- ⑧ Disaster prevention / crime prevention equipment
- ⑨ Data-processing equipment
- ⑩ Application of similar complexity and/or reliability requirements to the applications listed above

3 Product specifications in this catalog are as of March 2016. They are subject to change or our products in it may be discontinued without advance notice. Please check with our sales representatives or product engineers before ordering. If there are any questions, please contact our sales representatives or product engineers.

4 Please read rating and ⚠CAUTION (for storage, operating, rating, soldering, mounting and handling) in this catalog to prevent smoking and/or burning, etc.

5 This catalog has only typical specifications. Therefore, please approve our product specifications or transact the approval sheet for product specifications before ordering.

6 Please note that unless otherwise specified, we shall assume no responsibility whatsoever for any conflict or dispute that may occur in connection with the effect of our and/or a third party's intellectual property rights and other related rights in consideration of your use of our products and/or information described or contained in our catalogs. In this connection, no representation shall be made to the effect that any third parties are authorized to use the rights mentioned above under licenses without our consent.

7 No ozone depleting substances (ODS) under the Montreal Protocol are used in our manufacturing process.

Murata Manufacturing Co., Ltd.

www.murata.com

muRata
INNOVATOR IN ELECTRONICS

Mouser Electronics

Authorized Distributor

Click to View Pricing, Inventory, Delivery & Lifecycle Information:

Murata:

[DEHC32H222KA2B](#) [DEBF33A103ZN2A](#) [DEBE33F102ZC3B](#) [DEHR33F222KN7A](#) [DE2E3KH102MNA](#)
[DEC1X3J121JC4B](#) [DEA1X3D150JA1B](#) [DEA1X3A150JA1B](#) [DECB33J151KC4B](#) [DEC1X3J151JC4B](#)
[DEBE33D222ZA2B](#) [DEBE33A222ZA2B](#) [DEA1X3F391JA3B](#) [DEA1X3D391JA3B](#) [DECB33J101KC4B](#)
[DEA1X3A391JA2B](#) [DEA1X3A100JA1B](#) [DEA1X3D100JA1B](#) [DEHR33D152KEBB](#) [DEHR33D271KC3B](#)
[DEC1X3J270JC4B](#) [DEA1X3F180JCDB](#) [DEHR33F152KA3B](#) [DEHR33D152KA3B](#) [DE2E3KH332MA4B](#)
[DEHR33A152KA2B](#) [DE2F3KH103MA4B](#) [DEBB33D471KN2A](#) [DEA1X3F270JC3B](#) [DEA1X3F150JCDB](#)
[DEBE33D102ZA2B](#) [DEHC32H331KA2B](#) [DEBE33A102ZA1B](#) [DEA1X3A390JP2A](#) [DEHC32H681KA2B](#)
[DEHC32H332KA2B](#) [DEA1X3A101JN2A](#) [DE0705F472Z1K](#) [DEBB33F221KR5A](#) [DEA1X3D120J1AB](#)
[DECB33J221KC4B](#) [DEA1X3A120JA1B](#) [DEA1X3A220JA1B](#) [DEA1X3D220JA1B](#) [DEBB33A221KN2A](#)
[DEC1X3J220JC4B](#) [DEBE33F222ZA3B](#) [DEHC32H102KA2B](#) [DEBB33D471KA2B](#) [DEHR33D561KEBB](#)
[DEBB33A471KA1B](#) [DEBB33F471KA3B](#) [DEHR33D102KR1A](#) [DEA1X3F820JA3B](#) [DEBE33D103ZECB](#)
[DEA1X3A820JA2B](#) [DEA1X3D820JA2B](#) [DEHR33D102KB3B](#) [DEBB33A332KN2A](#) [DEA1X3F330JC3B](#)
[DEC1X3J101JC4B](#) [DEA1X3A470JP2A](#) [DEBE33A103ZA3B](#) [DEBE33D103ZA3B](#) [DEHR33D102KN3A](#)
[DEHR33F561KA3B](#) [DEHR33D561KA3B](#) [DE2E3KH102MEBB](#) [DEBB33F152KA3B](#) [DE-KIT-SAFETY-KXKH](#)
[DEBB33A152KA2B](#) [DEBB33D152KA2B](#) [DEHC32H152KA2B](#) [DEHR33A472KA4B](#) [DEHR33D472KA4B](#)
[DEHR33F272KA4B](#) [DEA1X3A221JN2A](#) [DEA1X3A121JN2A](#) [DEHR33A472KA3B](#) [DEHR33D272KA3B](#)
[DECE33J102ZC4B](#) [DEBB33F681KA3B](#) [DEBB33A102KQ1A](#) [DE2E3KH332MR5A](#) [DEHR33F222KA3B](#)
[DEHR33F122KA3B](#) [DEHR33D122KA3B](#) [DEHR33D222KA3B](#) [DEHR33A222KA3B](#) [DEBB33A681KA2B](#)
[DEHR33D821KEBB](#) [DEBB33D681KA2B](#) [DEHR33A222KA4B](#) [DEA1X3F390JC3B](#) [DEA1X3D390JC1B](#)
[DEA1X3A390JC1B](#) [DEBB33F102KA3B](#) [DEBB33D102KA2B](#) [DEBB33A102KA2B](#) [DESD33A222KN3A](#)