



E104-BT5010A User Manual

nRF52810 BLE5.0 Low Power BLE to Serial Module



Contents

1. OVERVIEW	4
1.1 INTRODUCTION	4
1.2 FEATURES	4
1.3 APPLICATION	4
2. PARAMETER	5
2.1 LIMIT PARAMETER	5
2.2 OPERATING PARAMETER	5
3. DIMENSION AND PIN DEFINITION	7
4. RECOMMENDED CONNECTION DIAGRAM	9
5. FUNCTION	9
5.1 ROLES	9
5.1.1 Master	10
5.1.2 Slave	10
5.1.3 Observer	10
5.2 POWER MODE	11
5.2.1 Low power mode	11
5.2.2 Wake up mode	11
5.3 ADVERTISING	11
5.3.1 Normal advertising info.	11
5.3.2 iBeacon advertising info.	12
5.4 CONFIGURATION	12
5.5 DATA INDICATION	12
5.6 UUID SPECIFICATION	13
5.7 STATUS AND EVENT PRINTING	13
6. AT COMMAND	14
6.1 COMMAND INSTRUCTION	14
6.2 ERROR CODE	14
6.3 STATUS PRINTING	15
6.4 COMMAND LIST	15
6.4.1 AT test command	15
6.4.2 AT+RESET Reset command	15
6.4.3 AT+RESTORE restore factory setting	15
6.4.4 AT+BAUD baud rate	15
6.4.5 AT+PARI parity	16
6.4.6 AT+ROLE Bluetooth role	16
6.4.7 AT+DEVMANUF modify manufacture name	17
6.4.8 AT+DEVSERIAL modify device serial	17
6.4.9 AT+DEVMODEL modify device model	17
6.4.10 AT+DEVHWER modify hardware version	18
6.4.11 AT+DEVSWVER modify software version	18
6.4.12 AT+DEVID modify device ID	18
6.4.13 AT+ADV enable advertising	18

6.4.14 AT+ADVSTAT advertising data	19
6.4.15 AT+ADVINTV advertising gap	19
6.4.16 AT+IBCNUUID iBeacon UUID command	19
6.4.17 AT+MAJOR iBeacon Major Command	20
6.4.18 AT+MINOR iBeacon Minor command	20
6.4.19 AT+IPWR modify ibeacon tx_power	20
6.4.20 AT+NAME advertise device name	21
6.4.21 AT+CONPARAMS connection gap configuration	21
6.4.22 AT+DISCON disconnect command	21
6.4.23 AT+DATDLY Data output delay	22
6.4.24 AT+MAC local MAC address	22
6.4.25 AT+PEERMAC connect to device MAC	22
6.4.26 AT+BOND enable bonding	23
6.4.27 AT+BONDMAC add more bond MAC address	23
6.4.28 AT+BONDDEL delete bond MAC address	23
6.4.29 AT+SCAN advertising scan	24
6.4.30 AT+SCANINTV scan interval	24
6.4.31 AT+SCANWND scan window	24
6.4.32 AT+AUTOCONN connect automatically	25
6.4.33 AT+CONN specify connection	25
6.4.34 AT+UUIIDSVR128 set 128-bit UUID	25
6.4.35 AT+UUIIDSVR Bluetooth service UUID	25
6.4.36 AT+UUIIDCHARA1 SLAVE CHANNEL characteristic UUID	26
6.4.37 AT+UUIIDCHARA2 MAST CHANNEL characteristic UUID command	26
6.4.38 AT+VER query software version No.	26
6.4.39 AT+AUTH set authentication password over air	27
6.4.40 AT+UPAUTH change authentication password over air	27
6.4.41 AT+PWR transmitting power	27
6.4.42 AT+ONSLEEP sleep once power on	27
6.4.43 AT+DISCSLEEP disconnect and get into sleep	28
6.4.44 AT+SLEEP get into sleep mode immediately	28
6.4.45 AT+LOGMSG operating condition output	28
7. QUICK START	29
7.1 GUIDANCE FOR CONFIGURATION MODE	29
7.1.1 UART configuration	29
7.1.2 Configuration over air	29
7.2 DATA TRANSMISSION	31
7.2.1 Data transparent transmission	31
7. HARDWARE DESIGN	32
8. FAQ	34
8.1 COMMUNICATION RANGE IS TOO SHORT	34
8.2 MODULE IS EASY TO DAMAGE	34
8.3 BIT ERROR RATE IS TOO HIGH	34
9. PRODUCTION GUIDANCE	35

9.1 REFLOW SOLDERING TEMPERATURE	35
9.2 REFLOW SOLDERING CURVE	35
10 RELATED PRODUCT	36
11 PACKAGE FOR BULK ORDER	37
REVERSION HISTORY	38
ABOUT US	38

1. Overview

1.1 Introduction

Small in size and low in power consumption, E104-BT5010A is a serial-to-BLE module based on BLE 5.0 working at 2.4Ghz. It works as both Bluetooth master and slave.

Based on nRF52810 from Nordic, the E104-BT5010A module is developed by Chengdu Ebyte. AT commands are available for parameter setting, thus operation is simple and fast. There are Bluetooth master, slave and observer modes. It functionally supports low-power broadcast, data transparent transmission, and air configuration. It is widely used in smart wear, home automation, home security, personal health care, smart home appliances, accessories and remote control, automotive, lighting, industrial Internet, intelligent data acquisition, intelligent control, etc. The maximum continuous transmission baud rate is 921600bps.



1.2 Features

- BLE 5.0;
- Bluetooth packet length is adjustable;
- Working mode: configuration and transparent transmission mode;
- Automatic advertising and connection after power on;
- Switch between IBeacon and common broadcast available;
- Serial wake up available;
- MAC bonding connection;
- Serial transparent transmission and format transmission;
- Various serial modes and baud rates;
- Self-defined 16-bit UUID and 128-bit UUID;
- PCB antenna;
- Bluetooth parameter configuration over air is available;
- Distance : 55m (@4dBm、2Mbps) ;
- Ultra-low power sleep, synchronous broadcast;
- MAC address binding available. The maximum binding data is 8 devices;
- There are two connection modes: manual connection, automatic connection;
- Dynamic modification of transmit power is available. The maximum power is 4dBm;
- Sniffing function available;
- MTU maximum is 247 bytes;
- Air data rate 2M,1M available;

1.3 Application

- Smart home and industrial sensors;

- Security system, positioning system;
- Building automation solutions;
- Wireless remote control, UAV;
- Wireless game remote control;
- Healthcare sensor;
- Wireless voice, wireless headphones;
- RFID;
- Automotive applications.

2. Parameter

2.1 Limit parameter

Main parameter	Performance		Note
	Min	Max	
Voltage supply [V]	0	3.6	Voltage over 3.6V will cause permanent damage to module
Blocking power [dBm]	-	10	Chances of burn is slim when modules are used in short distance
Operating temperature [°C]	-40	+85	-

2.2 Operating parameter

Main parameter		Performance			Remarks
		Min	Typ	Max	
Voltage supply [V]		1.7	3.3	3.6	≥ 3.3 V ensures output power
Communication level [V]			3.3		For 5V TTL, it may be at risk of burning down
Operating temperature [°C]		-40	-	+85	
Frequency [MHz]		2402	-	2480	ISM band
Stand-by current (μ A)		-	8	-	-
Transmitting power [dBm]		-	3.8	4	-
Receiving sensitivity [dBm]		-	-96	-	Bluetooth@lowenergymode
Random I/O	VIL/VIH	GND/0.7* VCC	-	0.3* VCC/VCC	-
	VOL/VOH	GND/VC C-0.4	-	GND+0.4/V CC	-
Sleep advertising current(default)		-	173	-	unit: μ A, default advertising gap is 1s, default 0dBm
Wake-up advertising current(default)		-	8.70	-	unit: mA, default advertising gap is 1s, default

				0dBm
Wake-up no advertising current(default)	-	8.68	-	unit: mA, default connection gap is 500ms, default 0dBm
wake-up connection current(default)	-	8.78	-	unit: mA, default 0dBm

Main parameter	Description	Remarks
Distance	60m	Test condition: clear and open area, antenna gain: 5dBi, @4dBm, antenna height: 2m
BLE protocol	BLE 5.0	-
Communication interface	UART	-
Package	SMD	-
Connector	1.27 mm	-
Size	11.5*16mm	-
Antenna	Ceramic antenna	50Ω Impedance
Weight	0.8±0.1g	

3. Dimension and Pin Definition

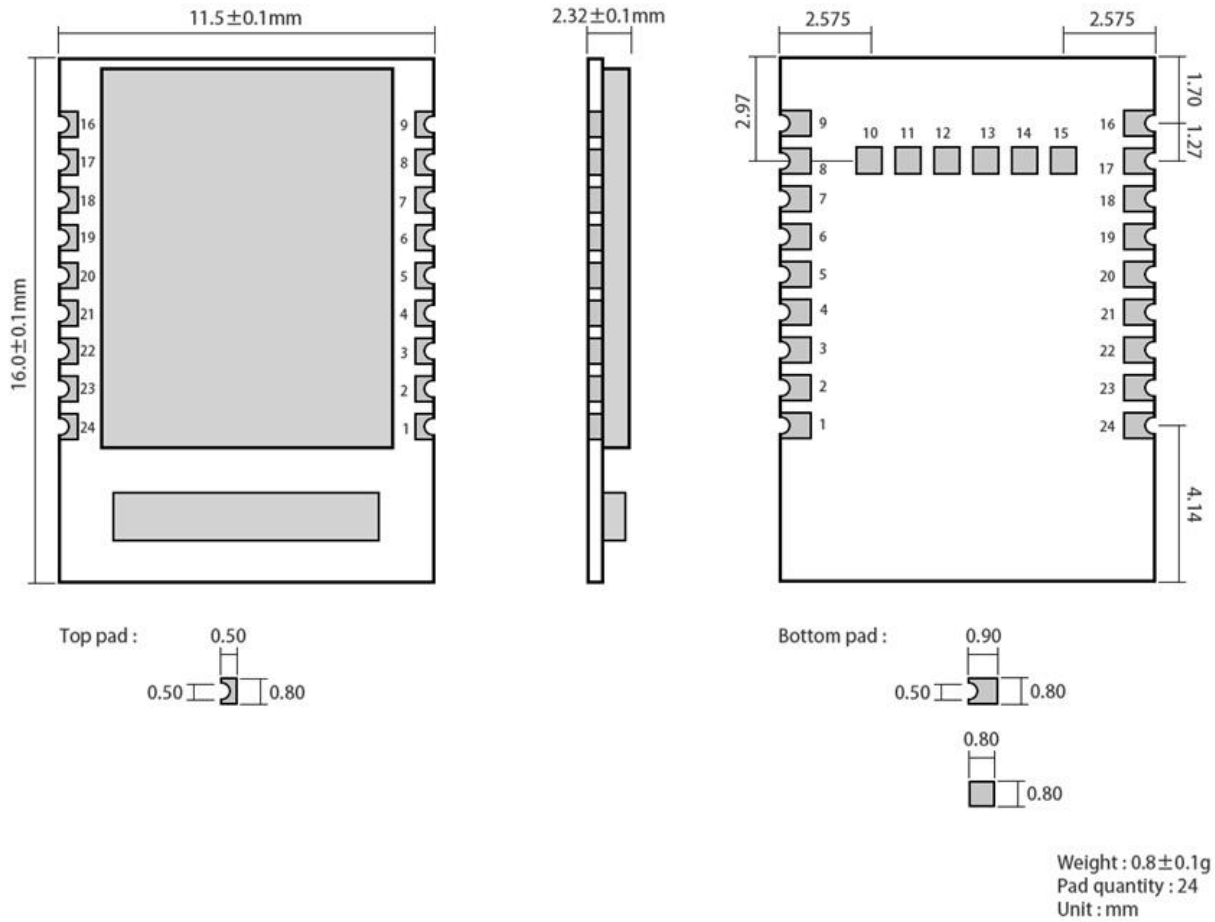

No.	Item	Direction	Application	Remarks
1	GND	Input	Ground	-
2	P0.25	-	NC	-
3	P0.26	-	NC	-
4	MOD ¹	Input	Mode selection	Low level: configuration mode; High level: transparent mode
5	WKP ²	Input	Wake up pin	Wake up: falling edge; Sleep: rising edge.
6	DISC	Input	Connection pin	Internal pull up. Valid in

¹ The internal level of the pin is self-latching. Ground directly or connect to the power supply when driving externally. When it is driven by external MCU, use the push output control.

² Same to 1.

			disconnected	falling edge
7	LINK ³	Output	Link status	Ble link: low level No ble link: high level
8	DATA ⁴	Output	Data indicator	Data indication pin, When the module outputs data through the serial port, the module sets the data pin to low level, indicating that data is being sent. The at instruction response does not change the state of the data pin.
9	GND	-	Ground	-
10	P0.02	-	NC	-
11	P0.03	-	NC	-
12	P0.04	-	NC	-
13	P0.05	-	NC	-
14	P0.06	-	NC	-
15	P0.07	-	NC	-
16	GND	-	Ground	Ground
17	VCC	-	Power	Power
18	RXD	Input	UART RX pin	-
19	TXD	Output	UART TX pin	-
20	RTS	Output	Flow control	Internal pull up
21	CTS	Input	Flow control	Internal pull up
22	P0.21/RST	-	Power reset	Valid in low level
23	SWDCLK	-	-	-
24	SWDIO	-	-	-

³ The internal level of the pin is self-latching. It internally pulls up for high level and pulls down for low level.

⁴ Same to 3.

4. Recommended connection diagram

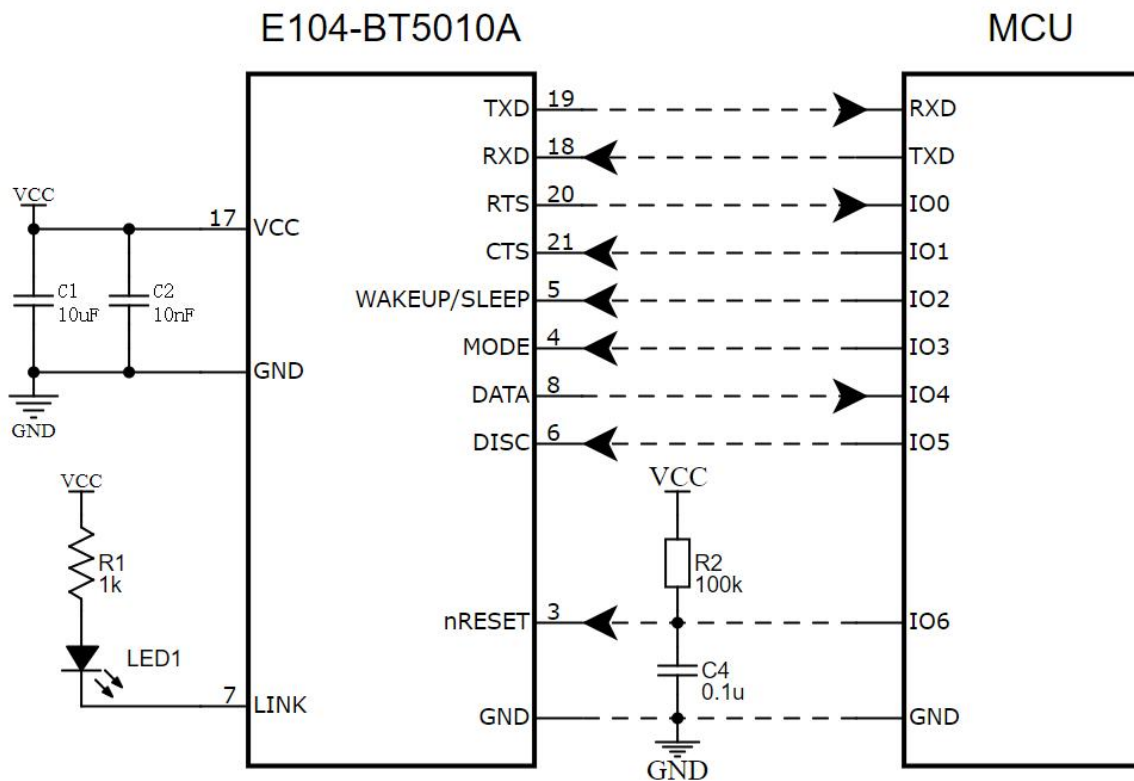

Note: The sensor refers to connecting an external device to a pin with an input function, the peripheral device refers to connecting an external device to a pin with an output function, and the MODE and WAKEUP / SLEEP pins refer to The two control pins are connected to the corresponding level state. If the module needs to be woken up, the WAKEUP / SLEEP (WKP) pin should be connected to a low level, or a falling edge signal should be given to the pin in time. If you need to switch between AT configuration mode and transparent transmission mode, you need to give the corresponding edge of the MODE (MOD) pin.

5. Function

5.1 Roles

There are three roles: master, slave, and observer.

The master module connects to other Ebyte Bluetooth models. Only one slave can be connected to it. Transparent advertising and format transmission are available. Both manual and automatic connection are allowed.

The slave module connects to other Ebyte Bluetooth models, only one connection is allowed. Only transparent transmission is available for slave.

The observer is only used to print information about the ble device around the module and cannot be connected.

5.1.1 Master

1. AT+ROLE=1 choose role as master;
2. AT+SCAN=1 master scanning started;
3. AT+AUTOCONN configure if it is automatically connected after power on;
4. Once in manual connection, AT+CONN configure to connect specific device;
5. One master and multiple slave connection is available. Maximum connected slave quantity is 4;
6. Print status information when the master connection status changes. See 6.3 for Status Print.

5.1.1.1 Master connecting method

5.1.1.1.1 Condition filtering

The device can be configured to filter by MAC address bonding and service UUID.

UUID filtering is filtered according to the content configured by AT+UUIDSVR. The filtering condition cannot be closed. If MAC address filtering is not enabled, the MAC matches, it is automatically connected to the slave once service UUID is matched.

If the user needs MAC address filtering, MAC address filtering needs to be enabled through AT+BOND=1, and the MAC address is added to the master through AT+BONDMAC. After the master scans to the slave, if it is the same as the binding list MAC address and the service UUID, it automatically connects to the slave device.

If the master is configured as a manual connection, MAC address binding filtering will be ignored, but svruuid is consistent.

5.1.1.1.2 Automatic connection

If configured to connect automatically, the slave is automatically connected after the condition filter is met.

If configured to connect manually, turn on scanning. The master will scan the device with the service UUID matched and output through the UART (the data format is as shown in Figure below, the master outputs the scan result data format). The user connects to the specified slave device using AT+CONN.

RSSI(Signal quality)	MAC
1byte	6byte

5.1.2 Slave

1. AT+ROLE=0 choose role as slave.
2. AT+ADV=1 configure normal advertising mode.
3. The broadcast switch is configured to be enabled. Once power on, it automatically enters the broadcast state. Otherwise, the broadcast device cannot be found.
4. After receiving the master connection request, establish a Bluetooth connection to stop the Bluetooth broadcast and enter the data transparent transmission mode.
5. Check 5.5 for advertising configuration.

5.1.3 Observer

1. AT+ROLE=2 choose role as observer (Reset to be valid) .
2. After receiving the broadcast, print out the entire contents of the broadcast package through the serial port.
3. It cannot connect any device.

Format:

LEN	MAC	RSSI	Advdata
1 byte	6 bytes	1 byte	Within 31 bytes

Notes: LEN is sum of MAC, RSSI and advertising data length.

4. Scanning window, gap and parameter should be the same.
5. AT command is valid during this time.

5.2 Power mode

There are two modes: low power mode and wake-up mode.

5.2.1 Low power mode

The low power mode means that the BLE function continues to run after entering this mode, and the peripherals except the wake-up pin are turned off. If you need lower power consumption, you can turn off the broadcast, scan, disconnect all connections, set a longer broadcast gap, scan the gap, and connect the gap by AT command.

Enter low power mode:

1. AT command "AT+SLEEP": enter low power mode;
2. AT command "AT+DISCSLEEP=1": disconnect and enter low power mode;
3. AT command "AT+ONSLEEP=1" : enter low power mode once power on;
4. Via pin WKP rising edge, keep high level for 200ms and enter low power mode;

To output "STA: sleep" via serial port after entering low power mode (LOGMSG output unclosed)。

Note: In low power mode, when it is not disconnected, for example, when ble receives data over air, or when the connection status changes, the module temporarily wakes up and outputs the corresponding data, and immediately goes to sleep after the data output is completed. At this point, entering low power consumption, or waking up will not output status data.

5.2.2 Wake up mode

In this mode, the peripherals of ble modules works normally. Once it waked up, it outputs "STA: wakeup".

Wake up mode:

1. Via pin WKP falling edge, keep low level for 200ms and enter wake up mode;
2. Pin RX wakes up, via falling edge of pin RX, keep low level for at least 50us and wake up immediately。

5.3 Advertising

5.3.1 Normal advertising info.

It includes advertising and scan response, advertising is actively sent report, scan response is responded report after receiving scan request from the master.

5.3.1.1 Advertising

Fixed field	Len	Manufa field	Manufa data
020106	N	0xFF	configurable, max is 26 bytes

For example: 020106< Len >FF< Manufa data >

Users can configure Manufa data only.

5.3.1.2 Scan response

Len	Fixed field	UUID	Len	Fixed field	Device name
0x03	0x03	FFF0	N	0x09	configurable, max is 22 bytes

For example: 0303FFF0<len>09< Device name >

Note: users do not need to configure this data.

5.3.2 iBeacon advertising info.

1. Commands are for UUID, Major, Minor.
2. AT+ADV=2: set to work in iBeacon mode to advertise immediately.
3. In iBeacon advertising, ble connection is unavailable.

5.3.2.1 Advertising

iBeacon Prefix	UUID	Major	Minor	Tx-Power
9B	16B	2B	2B	1B

For example: 0201061AFF4C000215FDAFDA50693A4E24FB1AFCFC6EB076478252775848F00

5.4 Configuration

There are two configuration modes: serial port configuration and air configuration. They are basically the same. Before the air configuration, the authentication password AT+AUTH=123456 must be passed. Once it is passed, the module is allowed to use the air configuration. The authentication period is the current connection. When disconnected and reconnected, it needs to be re-authenticated.

The module is in configuration mode before the connection is established. The Mod pin is invalid.

After the connection is successful, it is determined whether the module is currently in the configuration mode or the data transmission mode according to the mod pin level. When mod is high, it is the data transfer mode, and when it is low, it is the configuration mode.

The Mod pin latches the current state when a valid change is detected. Each state change hold time is valid for at least 200ms.

The Mod pin has no effect on the air configuration.

In configuration mode, the mster sends data to “MAST CHANNEL” and the slave returns “CONFIG BUSY” via “SLAVE CHANNEL”.

5.5 Data indication

When data is output through the serial port, the DATA pin is set to low level, indicating that data is being transmitted. The AT command response does not change the state of the DATA pin.

Data output delay is enabled via with AT+DATALLY=1. After it is turned on, the module first pulls the DATA pin and outputs the

data after 10ms.

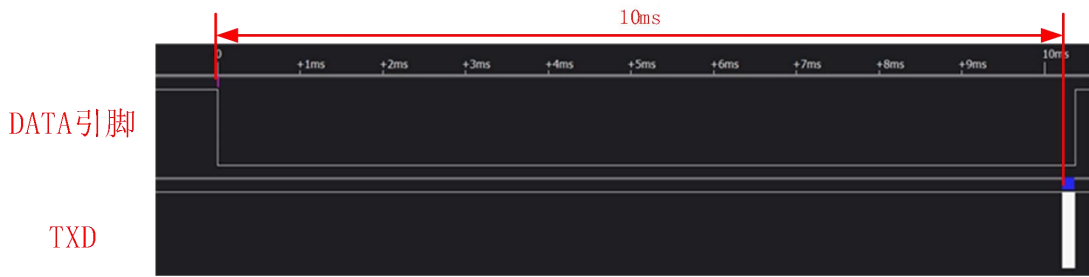

Data output delay

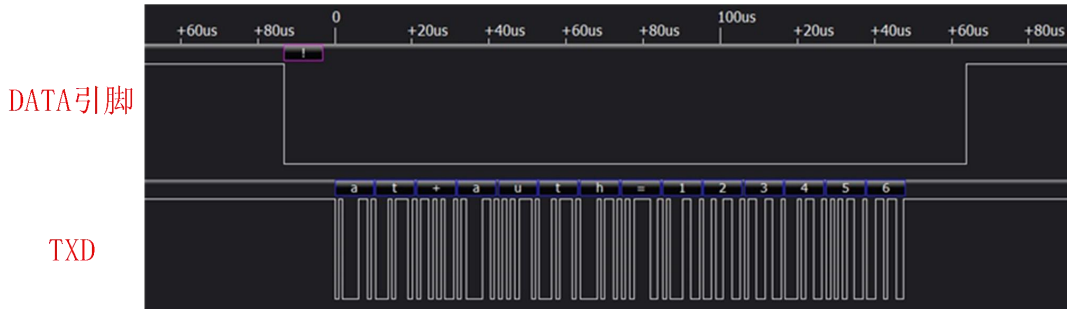

No delay of data output

5.6 UUID specification

Service UUID	FFF0 (configurable)		
Characteristic value	UUID	Property	Description
SLAVE CHANNEL	FFF1 (configurable)	read / notify	Slave sends data, master receives data
MAST CHANNEL	FFF2 (configurable)	read / write	Maser sends data, slave receives data
CONFIG CHANNEL	FFF3 (unconfigurable)	read / write / notify	Channel for configuration over air

5.7 Status and event printing

Command AT+LOGMSG is for configuring status and enable uart printing, printing info as below: connect, disconnect, wakeup and sleep, in format below

Status	Printing info
Connect	\r\n STA:connect\r\n
Disconnect	\r\n STA:disconnect\r\n
System wake up	\r\n STA:wakeup\r\n
Sleep mode	\r\n STA:sleep\r\n

6. AT command

Note: keep module in wake-up mode before sending cooperation command.

6.1 Command instruction

- There is no enter (`\r`) or LF(`\n`) required for AT command.
- AT Command return info is ended with `\r\n` (except for return HEX)
- Command error response format `+ERR=[NUM]`. (**NUM is ACSII**)

6.2 Error code

NUM	Description	Error reason	Solution
0	Currently parsing AT	Gap between two AT commands is too small	Proper delay is added between two AT commands
1	Command does not exist	AT command string is incorrect	Check AT command character string
2	Incorrect parameter length	1、 AT command length is incorrect; 2、 Length does not meet range	Check parameter
3	Invalid parameter	1 Parameter exceeds value range	Refer to command to check right parameter
4	Air wakeup authentication failed	Incorrect password	1、 Use correct configuration password; 2、 Reset password via UART
5	Current device role, this command is not supported		This command is forbidden in current role
6	Unknown mistake		
7	Save parameter error		
8	AT command exists, but operation not supported		Refer to command and operate again
9	Disconnected	Module is disconnected	
10	MAC address does not exist	Added MAC address exists already	
11	MAC list is full	MAC address bond exceeds the maximum numbers	Delete invalid MAC, add again
12	MAC address does not exist	Deleted MAC does not exist	
13	Connection failed		
14	Exceeded the maximum number of current connections	The current masters are all connected	1、 Disconnect current devices; 2、 Modify maximum connection numbers;
15	Device does not exist		

Error code list

6.3 Status printing

Status	Printing info	
Connected successfully	Slave	\r\nSTA:connect\r\n
	Master	\r\nSTA:connect,1,<MAC\r\n
Disconnect	Slave	\r\nSTA:disconnect\r\n
	Master	\r\nSTA:disconnect,1\r\n
System wake up	\r\nSTA:wakeup\r\n	
Sleep mode	\r\nSTA:sleep\r\n	

Status printing list

6.4 Command list

6.4.1 AT test command

command	respond
AT	+OK
Remark: None	

6.4.2 AT+RESET Reset command

command	respond
AT+RESET	+OK
Remark: take into effect immediately	

6.4.3 AT+RESTORE restore factory setting

command	respond
AT+RESTORE	OK
Remark: 1、 after the reset, automatically restart; 2、 During the process of restoring the factory settings, any form of reset is prohibited, must not power off before it is completed.;	

6.4.4 AT+BAUD baud rate

	command	respond
Inquire	AT+BAUD?	+OK=[para]
Set	AT+BAUD=[para]	+OK: success

		+ERR=[NUM]: error
Parameter	para (ASCII)	Baud rate(bps)
	0	1200
	1	2400
	2	4800
	3	9600
	4	14400
	5	19200
	6	28800
	7	38400
	8	57600
	9	76800
	10	115200 (default)
	11	230400
	12	250000
	13	460800
14	921600	
Remark	take into effect after reset	
For example	AT+BAUD=10, baud rate is 115200 HEX: 41,54,2B,42,41,55,44,3D,31,30	

6.4.5 AT+PARI parity

	Command	respond
Inquire	AT+PARI?	+OK=[para]
Set	AT+PARI=[para]	+OK: success +ERR=[NUM]: error
Parameter	para(ASCII)	Description
	0	None (default)
	1	Even
Remark	take into effect after reset and save when power off	
For example	AT+PARI=0	

6.4.6 AT+ROLE Bluetooth role

	Command	respond
Inquire	AT+ROLE?	+OK=[para]
Set	AT+ROLE=[para]	+OK: success +ERR=[NUM]: error

Parameter	Para(ASCII)	Description
	0	Slave (default)
	1	Master
	2	Observer
Remark	take into effect after reset and save when power off	

6.4.7 AT+DEVMANUF modify manufacture name

	command	respond
Inquire	AT+DEVMANUF?	+OK=[para]
Set	AT+DEVMANUF =[para]	+OK: success +ERR=[NUM]: error
Parameter	para(string): manufacture name Default: CDEBYTE;	
Remark	1、 take into effect after reset and save when power off 2、 string is up to 32bytes	

6.4.8 AT+DEVSERIAL modify device serial

	command	respond
Inquire	AT+DEVSERIAL?	+OK=[para]
Set	AT+ DEVSERIAL =[para]	+OK: success +ERR=[NUM]: error
Parameter	para(string): device serial default:123456;	
Remark	1、 take into effect after reset and save when power off 2、 string is up to 32bytes	

6.4.9 AT+DEVMODEL modify device model

	Command	respond
Inquire	AT+DEVMODEL?	+OK=[para]
Set	AT+ DEVMODEL =[para]	+OK: success +ERR=[NUM]: error
Parameter	para(string): device model NO. Default:E104-BT50;	
Remark	1、 take into effect after reset and save when power off 2、 string is up to 32bytes	

6.4.10 AT+DEVHWVER modify hardware version

Command		respond
Inquire	AT+DEVHWVER?	+OK=[para]
Set	AT+ DEVHWVER =[para]	+OK: success +ERR=[NUM]: error
Parameter	para(string): device hardware version Default: V1.0;	
Remark	1、 take into effect after reset and save when power off 2、 string is up to 32bytes	

6.4.11 AT+DEVSWVER modify software version

command		respond
Inquire	AT+DEVSWVER?	+OK=[para]
Set	AT+ DEVSWVER =[para]	+OK: success +ERR=[NUM]: error
Parameter	para(string): device software version Default: V1.0;	
Remark	1、 take into effect after reset and save when power off 2、 string is up to 32bytes	

6.4.12 AT+DEVID modify device ID

command		respond
Inquire	AT+DEVID?	+OK=[para]
Set	AT+ DEVID =[para]	+OK: success +ERR=[NUM]: error
Parameter	para (HEX) :device ID; Default: <MAC> 00 00	
Remark	1、 take into effect after reset and save when power off; 2、 Max length is 8bytes	

6.4.13 AT+ADV enable advertising

command		respond
Inquire	AT+ADV?	+OK=[para]
Set	AT+ADV=[para]	+OK: success +ERR=[NUM]: error

Parameter	para (ASCII)	Description
	0	Close advertising
	1	Normal advertising (default)
	2	iBeacon
Remark	1、 Take into effect immediately (if advertising is not enabled, or it is connected, then take into effect next time), save when power off; 2、 Available for slave only.	

6.4.14 AT+ADVDAT advertising data

command		respond
Inquire	AT+ADVDAT?	+OK=[para]
Set	AT+ADVDAT=[para]	+OK: success +ERR=[NUM]: error
Set (do not save)	AT+ADVDAT1=[para]	
Parameter	para(HEX): 1、 Available for ASCII、 HEX 2、 Length is within 26 bytes	
Remark	1、 Take into effect immediately (if advertising is not enabled, or it is connected, then take into effect next time), save when power off; 2、 Advertising available for slave only, other role can configurate;	
For example	command: 41 54 2b 41 44 56 44 41 54 3d 31 32 33 34 35 36 37 38 39 30; advertising data: 31 32 33 34 35 36 37 38 39 30	

6.4.15 AT+ADVINTV advertising gap

command		respond
Inquire	AT+ADVINTV?	+OK=[para]
Set	AT+ADVINTV=[para]	+OK: success +ERR=[NUM]: error
Parameter	para(ASCII):32~16384 Default: 1600 (1S)	
Remark	1、 Take into effect immediately (if advertising is not enabled, or it is connected, then take into effect next time), save when power off; 2、 Advertising available for slave only, other role can configurate;	
For example	AT+ADVINTV=1600 Set advertising gap: 1600*0.625=1S	

6.4.16 AT+IBCNUUID iBeacon UUID command

command	respond
---------	---------

Inquire	AT+HBCNUUID?	+OK=[para1]
Set	AT+HBCNUUID=[para]	+OK: success +ERR=[NUM]: error
Parameter	para(HEX): 16 位 UUID	
Remark	1、 Take into effect immediately (if advertising is not enabled, or it is connected, then take into effect next time) , save when power off; 2、 Advertising available for slave only, other role can configurate;	
For example	Set iBeacon UUID: “FDA50693A4E24FB1AFCFC6EB07647825”AT+HBCNUUID=FDA50693A4E24FB1AFCFC6EB07647825	

6.4.17 AT+MAJOR iBeacon Major Command

command		respond
Inquire	AT+MAJOR?	+OK=[para]
Set	AT+MAJOR=[para]	+OK: success +ERR=[NUM]: error
Parameter	para(ASCII): 1~65535 Default: 513	
Remark	1. Take into effect immediately (if advertising is not enabled, or it is connected, then take into effect next time) , save when power off; 2. Advertising available for slave only, other role can configurate;	

6.4.18 AT+MINOR iBeacon Minor command

command		respond
Inquire	AT+Minor?	+OK=[para]
Set	AT+Minor=[para]	+OK: success +ERR=[NUM]: error
Parameter	para(ASCII): 1~65535 Default: 1027	
Remark	1. Take into effect immediately (if advertising is not enabled, or it is connected, then take into effect next time) , save when power off; 2. Advertising available for slave only, other role can configurate;	

6.4.19 AT+IPWR modify ibeacon tx_power

command		respond
Inquire	AT+IPWR?	+OK=[para]
Set	AT+ IPWR =[para]	+OK: success +ERR=[NUM]: error
Parameter	para(ASCII): -128~127	

	Default: 0
Remark	1. Take into effect immediately (if advertising is not enabled, or it is connected, then take into effect next time) , save when power off; 2. Advertising available for slave only, other role can configurate;

6.4.20 AT+NAME advertise device name

command		respond
Inquire	AT+NAME?	+OK=[para]
Set	AT+NAME=[para]	+OK: success +ERR=[NUM]: error
Set (Do not save)	AT+NAME1=[para]	
Parameter	para(HEX): advertise device name device name is within 22 bytes Default: E104-BT5010A	
Remark	1、 Take into effect immediately, save when power off 2、 Advertising available for slave only, other role can configurate	

6.4.21 AT+CONPARAMS connection gap configuration

command		respond
Inquire	AT+CONPARAMS?	+OK=[intv],[latency],[timeout]
Set	AT+ CONPARAMS = [intv],[latency],[timeout]	+OK: success +ERR=[NUM]: error
Parameter	[intv] (ASCII) : connection gap, range, 6~3200; [latency] (ASCII) : slave delay. range, 0~499 [timeout] (ASCII) : connection timeout, range, 10~3200 Default: 16, 0, 400	
Remark	Take into effect immediately, save when power off	
Note	1、 Connection timeout must be more than connection gap 2、 Timeout *4 > (1 + latency)* intv; 3、 Error parameter device will not save 4、 We do not recommend to change the master connection gap	
For example	AT+CONPARAMS=16,0,400 Connection gap 16*1.25ms,slave will delay: 0, 16*1.25ms, connection timeout 400*1.25ms	

6.4.22 AT+DISCON disconnect command

command	respond
---------	---------

Set (only for master)	AT+DISCON=[para]	+OK: success +ERR=[NUM]: error
Disconnect all	AT+DISCON	+OK: success +ERR=[NUM]: error
Parameter	Para (ASCII)	description
	0~3	Disconnect all
Remark	1、take into effect immediately. 2、as slave, only disconnect all is available; 3、Disconnect all is available for master and slave mode; 4、if para specified connection but does not connect, the module will return +OK.	

6.4.23 AT+DATDLY Data output delay

	command	respond
Query	AT+DATDLY?	+OK=[para]
Set	AT+DATDLY=[para]	+OK: success +ERR=[NUM]: error
Parameter	para (ASCII)	description
	0	close
	1	enable(default)
Remarks	Take into effect immediately, save when power off	

6.4.24 AT+MAC local MAC address

	command	respond
Query	AT+MAC?	+OK=[para]
Parameter	para (HEX) :MAC address For example: F0E1D2C3B4A5	
Remarks	Take into effect immediately, save when power off	
For example	Command: AT+MAC? Return: 2B 4F 4B 3D FE 30 EE 50 35 DA Description: local MAC is FE 30 EE 50 35 DA	

6.4.25 AT+PEERMAC connect to device MAC

	command	respond
Set	AT+PEERMAC?	+OK=[para]: success +ERR=[NUM]: error

Parameter	para (HEX) :MAC address
Remarks	Take into effect immediately, only valid for slave
For example	Command: AT+PEERMAC? Return: 2B 4F 4B 3D FE 30 EE 50 35 DA Description: local MAC is FE 30 EE 50 35 DA

6.4.26 AT+BOND enable bonding

command		respond
Query	AT+BOND?	+OK=[para]
Set	AT+BOND=[para]	+OK: success +ERR=[NUM]: error
Parameter	para (ASCII)	description
	0	Bonding disabled (default)
	1	Enable bonding
Remarks	Take into effect immediately, save when power off	

6.4.27 AT+BONDMAC add more bond MAC address

command		respond
Query	AT+BONDMAC?	+OK=[sum][[mac] [mac]...]
Set	AT+BONDMAC=[mac]	+OK success +ERR=[NUM]: error
Parameter	sum(HEX): current bond MAC address numbers; mac(HEX): 6bytes mac address;	
Remarks	Take into effect immediately, save when power off	
For example	Query: AT+BONDMAC? Return: B 4F 4B 3D 03 CC 34 27 1A 0C D4 3D AC 82 16 0F 58 D2 D4 C3 07 0E C4	
	Set: 41 54 2B 42 4F 4E 44 4D 41 43 3D CC 34 27 1A 0C D4 Return: +OK	

6.4.28 AT+BONDDDEL delete bond MAC address

command		respond
Set	AT+BONDDDEL=[mac]	+OK +ERR=[NUM]
Parameter	mac: 6bytes mac address	
Remarks	1、 Take into effect immediately, save when power off 2、 When MAC is (0xff,0xff,0xff,0xff,0xff,0xff) delete all MAC address, or delate specified mac address;	

6.4.29 AT+SCAN advertising scan

command		respond
Query	AT+SCAN?	+OK=[para]
Set	AT+SCAN=[para]	+OK: success +ERR=[NUM]: error
Parameter	para (ASCII)	Description
	0	Scan closed
	1	Scan enabled(default)
Remarks	1、 Take into effect immediately, save when power off 2、 If current connected masters are the maximum, no scanning will be enabled 3、 Scanning is only available for master and observer	

6.4.30 AT+SCANINTV scan interval

command		Respond
Query	AT+SCANINTV?	+OK=[para]
Set	AT+SCANINTV=[para]	+OK: success +ERR=[NUM]: error
Parameter	para(ASCII):4~65535 Default: 160	
Remarks	1、 Take into effect immediately, save when power off 2、 Scanning interval is more than scanning window 3、 Unavailable for slave, but configuration is ok	
For example	AT+SCANINTV=120 Interval: $120 * 0.625 = 75\text{ms}$	

6.4.31 AT+SCANWND scan window

command		respond
Query	AT+SCANWND?	+OK=[para]
Set	AT+SCANWND=[para]	+OK: success +ERR=[NUM]: error
Parameter	para(ASCII): 4~65535 Default: 80;	
Remarks	1、 Take into effect immediately, save when power off 2、 Scanning interval is more than scanning window 3、 Unavailable for slave, but configuration is ok	
For example	AT+SCANWND=20 Interval: $20 * 0.625 = 12.5\text{ms}$	

6.4.32 AT+AUTOCONN connect automatically

command		respond						
Query	AT+AUTOCONN?	+OK=[para]						
Set	AT+ AUTOCONN =[para]	+OK: success +ERR=[NUM]: error						
Parameter	<table border="1"> <thead> <tr> <th>para (ASCII)</th> <th>Description</th> </tr> </thead> <tbody> <tr> <td>0</td> <td>Manual connection</td> </tr> <tr> <td>1</td> <td>Automatic connection (default)</td> </tr> </tbody> </table>		para (ASCII)	Description	0	Manual connection	1	Automatic connection (default)
	para (ASCII)	Description						
	0	Manual connection						
1	Automatic connection (default)							
Remarks	1、 Take into effect immediately, save when power off							

6.4.33 AT+CONN specify connection

command		respond
Set	AT+ CONN = [mac]	+OK: success +ERR=[NUM]: error
Parameter	mac(hex): specify mac connection	
Remarks	1、 Take into effect immediately, save when power off	

6.4.34 AT+UUIIDSVR128 set 128-bit UUID

command		respond
Query	AT+UUIIDSVR128?	+OK=[para]
Set	AT+ UUIIDSVR128=[para]	+OK: success +ERR=[NUM]: error
Parameter	para(HEX):16-bit uuid.	
Remarks	1、 take into effect after reset and save when power off. 2、 the 2, 3byte is 16-bit uuid, ranging from 1~65535; 3、 128-bit UUID, except for 2, 3byte, are used for the slave, the master and configuration channel.(Check details about uuid from 《BLUETOOTH SPECIFICATION Version 5.0 Vol 3, Part B 2.5.1 UUID》).	
For example	Set 128-bit UUID: "11 22 33 44 55 66 77 88 99 00 aa bb cc dd ee ff"(HEX) AT command is (HEX) : 61 74 2b 75 75 69 64 73 76 72 31 32 38 3d 11 22 33 44 55 66 77 88 99 00 aa bb cc dd ee ff	

6.4.35 AT+UUIIDSVR Bluetooth service UUID

command		respond
Query	AT+UUIIDSVR?	+OK=[para]

Set	AT+UUIDSVR=[para]	+OK: success +ERR=[NUM]: error
Parameter	para(ASCII): UUID value 1 ~ 65535	
Remarks	1、 Take into effect after reset, save when power off 2、 for the master, service UUID is necessary for connection filtering, thus master UUID shall be same as that of the slave.	

6.4.36 AT+UUIDCHARA1 SLAVE CHANNEL characteristic UUID

	command	respond
Query	AT+UUIDCHARA1?	+OK=[para]
Set	AT+UUID CHARA1= [para]	+OK: success +ERR=[NUM]: error
Parameter	para(ASCII): 1 ~ 65535 Default: 65521	
Remarks	1、 Take into effect after reset, save when power off 2、 The slave channel for data sent from the salve to the master.	

6.4.37 AT+UUIDCHARA2 MAST CHANNEL characteristic UUID command

	command	respond
Query	AT+UUIDCHARA2?	+OK=[para]
Set	AT+UUID CHARA2= [para]	+OK: success +ERR=[NUM]: error
Parameter	para(ASCII): 1 ~ 65535; Default: 65522	
Remarks	1、 Take into effect after reset, save when power off 2、 The master channel for data sent from the master to the slave.	

6.4.38 AT+VER query software version No.

	Command	respond
Query	AT+VER?	+OK=[para]
Parameter	para: version NO.	
Remarks	Take into effect immediately	
For example	command: AT+VER? return: +OK=1.0.0	

6.4.39 AT+AUTH set authentication password over air

command		respond
Set	AT+AUTH =[para]	+OK: success +ERR=[NUM]: error
Parameter	para(HEX): 6-byte password	
Remarks	1、 This command is for set over air 2、 Default password: 123456	
For example	AT+AUTH=123456	

6.4.40 AT+UPAUTH change authentication password over air

command		respond
Query	AT+UPAUTH?	+OK=[para]
Set	AT+UPAUTH =[para]	+OK: success +ERR=[NUM]: error
Parameter	para(HEX): 6-byte password	
Remarks	Take into effect immediately, save after power off	

6.4.41 AT+PWR transmitting power

command		respond
Query	AT+ PWR?	+OK=[para]
Set	AT+ PWR =[para]	+OK: success +ERR=[NUM]: error
Parameter	para(ASCII)	val
	0	4 dBm
	1	3 dBm
	2	0 dBm (default)
	3	-4 dBm
	4	-8 dBm
	5	-12 dBm
	6	-16 dBm
	7	-20 dBm
8	-40 dBm	
Remarks	Take into effect immediately, save after power off	

6.4.42 AT+ONSLEEP sleep once power on

command	respond
---------	---------

command		respond						
Query	AT+ONSLEEP?	+OK=[para]						
Set	AT+ONSLEEP =[para]	+OK: success +ERR=[NUM]: error						
Parameter	<table border="1"> <thead> <tr> <th>para (ASCII)</th> <th>Description</th> </tr> </thead> <tbody> <tr> <td>0</td> <td>Disenable(default)</td> </tr> <tr> <td>1</td> <td>Enable</td> </tr> </tbody> </table>		para (ASCII)	Description	0	Disenable(default)	1	Enable
	para (ASCII)	Description						
	0	Disenable(default)						
1	Enable							
Remarks	Take into effect immediately, save after power off							

6.4.43 AT+DISCSLEEP disconnect and get into sleep

command		respond						
Query	AT+DISCSLEEP?	+OK=[para]						
Set	AT+DISCSLEEP =[para]	+OK: success +ERR=[NUM]: error						
Parameter	<table border="1"> <thead> <tr> <th>para (ASCII)</th> <th>description</th> </tr> </thead> <tbody> <tr> <td>0</td> <td>Disconnect (default)</td> </tr> <tr> <td>1</td> <td>Disconnect and get into sleep</td> </tr> </tbody> </table>		para (ASCII)	description	0	Disconnect (default)	1	Disconnect and get into sleep
	para (ASCII)	description						
	0	Disconnect (default)						
1	Disconnect and get into sleep							
Remarks	Take into effect immediately, save after power off							

6.4.44 AT+SLEEP get into sleep mode immediately

command		respond
Set	AT+SLEEP	+OK
Parameter	None	
Remarks	Take into effect immediately	

6.4.45 AT+LOGMSG operating condition output

command		respond						
Query	AT+LOGMSG?	+OK=[para]						
Set	AT+LOGMSG =[para]	+OK: success +ERR=[NUM]: error						
Parameter	<table border="1"> <thead> <tr> <th>para (ASCII)</th> <th>description</th> </tr> </thead> <tbody> <tr> <td>0</td> <td>Disenable(default)</td> </tr> <tr> <td>1</td> <td>Enable</td> </tr> </tbody> </table>		para (ASCII)	description	0	Disenable(default)	1	Enable
	para (ASCII)	description						
	0	Disenable(default)						
1	Enable							
Remarks	Take into effect immediately, save after power off							

7. Quick start

Recommended debugging and testing software:

- Serial tool on PC - SSCOM.exe;
- Ble debugging APP on phone- nRF connect.

7.1 Guidance for configuration mode

7.1.1 UART configuration

- Check if the module is in configuration mode (When not connected, it can be configured, otherwise, set pin mod as low level)
- Set SSCOM string related parameter (default: 115200, 8, 1, none, no flow control) ;

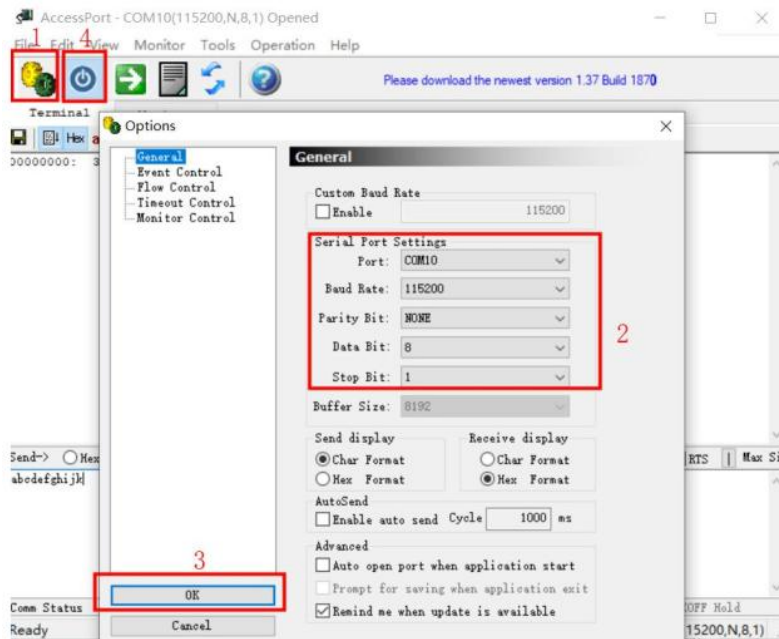

SSCOM parameter setting figure

- Refer to 6.4 command list to configure the module;

7.1.2 Configuration over air

- When module works as the slave, configuration over air is available.
- Open app “nRF connect”, start scanning device, find “E104-BT5010A” to connect;

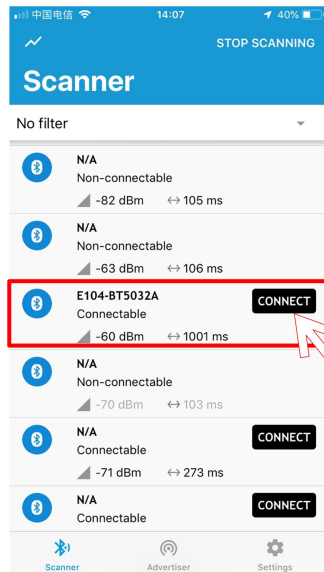

nRF connect scanning figure

- Open service fff0 of uuid, enable configuration channel notify;

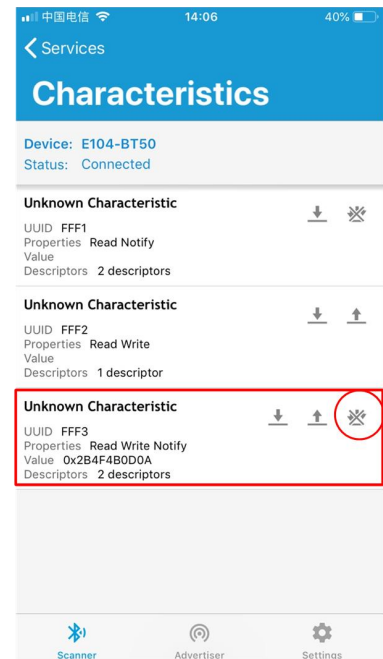
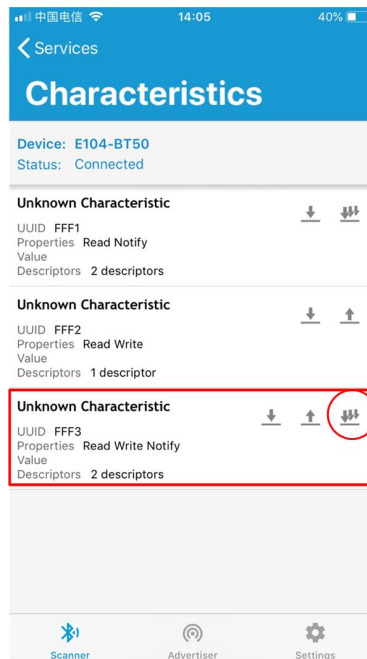
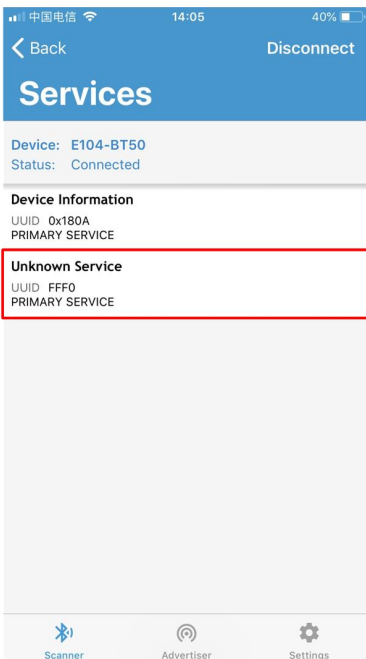

nRF connect-connect and enable notify

- Send authentication command (at+auth=12345) , when it returns “0x2befeb0d0a”, means successful authentication;

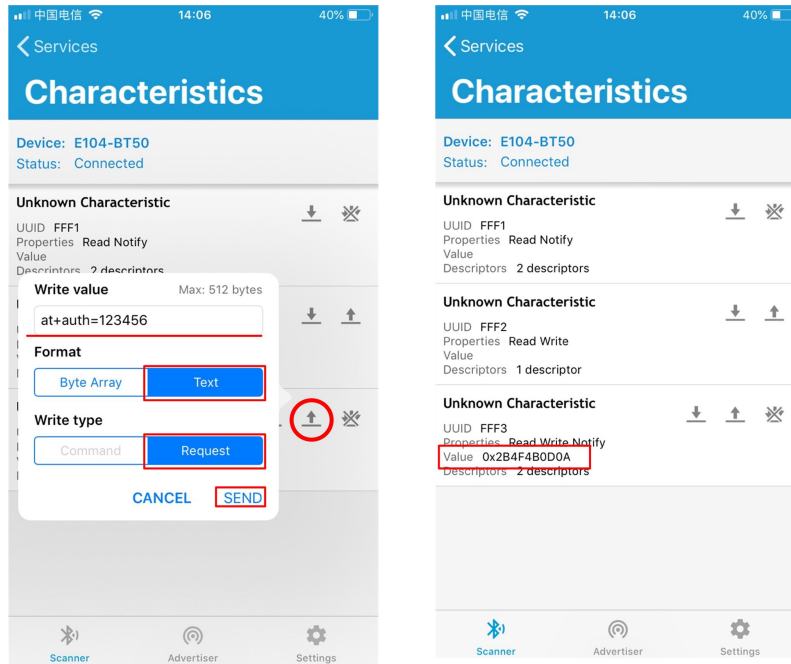

Authentication of configuration over air

- Refer to 6.4 command list to configure the module;

7.2 Data transmission

Please refer to 5.3 data transmission mode for details.

Test condition:

- Refer to 7.1, set one module as the master and the other one as the slave;
- Test software: SSCOM;
- Other parameters are as default.

7.2.1 Data transparent transmission

1. Once powered on, the master and the slave enable logmsg to print (at+logmsg=1) ;
2. Set module as transparent transmission mode (AT+TRANMD=1) ;
3. Once connected , the master prints “STA:connect,0,619AA43CBAF3”; the slave prints “STA:connected”. LINK pin is low.

Please refer to figure below. From master’s printing info, the value before the MAC address is sentences from the slave, where the first byte of format transmission comes.

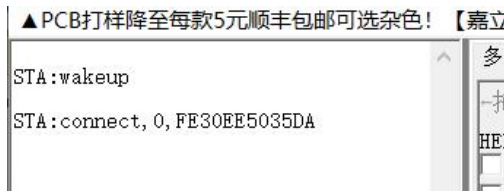

Automatically connect and print once the master is powered on

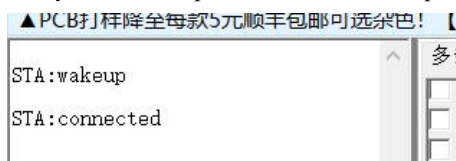

Automatically connect and print once the slave is powered on

4. Data “0123456789” is sent from the master to the slave (refer to master’s transparent transmission below) ;
5. Data “abcdefghijk” is sent from the slave to the master (refer to master’s transparent transmission below);

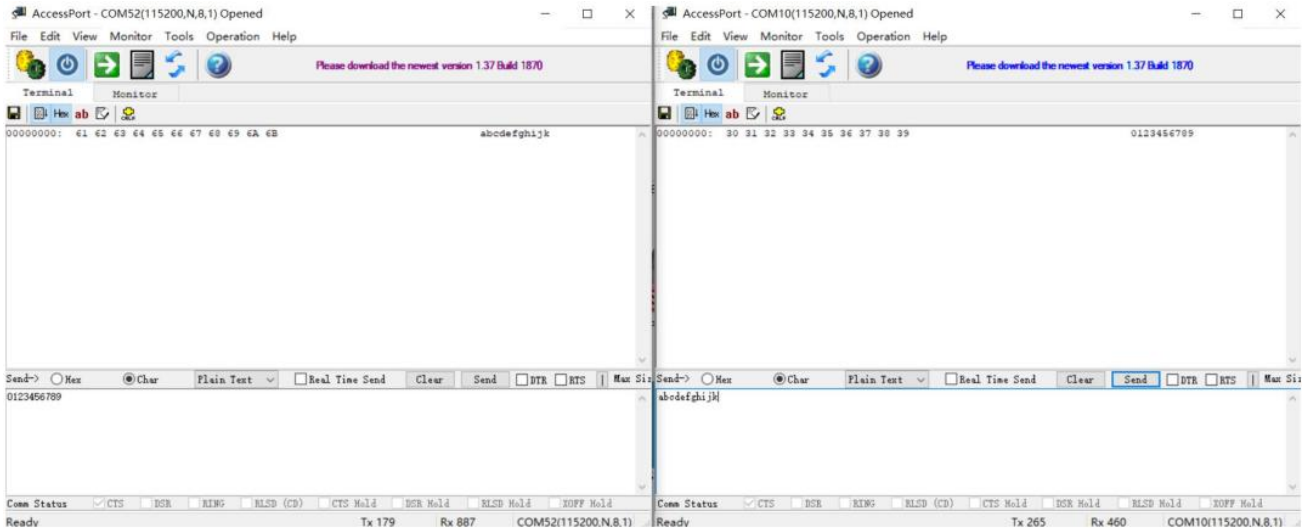

Master’s transparent transmission

7. Hardware design

- It is recommended to use a DC stabilized power supply. The power supply ripple factor is as small as possible and the module needs to be reliably grounded.
- Please pay attention to the correct connection of the positive and negative poles of the power supply.
- Reverse connection may cause permanent damage to the module;
- Please check the power supply to ensure it is within the recommended voltage otherwise when it exceeds the maximum value the module will be permanently damaged;
- Please check the stability of the power supply, the voltage cannot be fluctuated frequently;
- When designing the power supply circuit for the module, it is often recommended to reserve more than 30% of the margin, so the whole machine is beneficial for long-term stable operation.
- The module should be as far away as possible from the power supply, transformers, high-frequency wiring and other parts with large electromagnetic interference
- High-frequency digital routing, high-frequency analog routing, and power routing must be avoided under the module. If it is necessary to pass through the module, assume that the module is soldered to the Top Layer, and the copper is spread on the Top Layer of the module contact part(well grounded), it must be close to the digital part of the module and routed in the Bottom Layer;
- Assuming the module is soldered or placed over the Top Layer, it is wrong to randomly route over the Bottom Layer or other layers, which will affect the module's spurs and receiving sensitivity to varying degrees.
- It is assumed that there are devices with large electromagnetic interference around the module that will greatly affect the performance. It is recommended to keep them away from the module according to the strength of the interference. If necessary, appropriate isolation and shielding can be done;
- Assume that there are traces with large electromagnetic interference (high-frequency digital, high-frequency analog, power traces) around the module that will greatly affect the performance of the module. It is recommended to stay away from the module according to the strength of the interference. If necessary, appropriate isolation and shielding can be done.

- Try to stay away from some physical layers such as TTL protocol at 2.4GHz , for example: USB3.0;
- The mounting structure of antenna has a great influence on the performance of the module. It is necessary to ensure that the antenna is exposed, preferably vertically upward. When the module is mounted inside the case, use a good antenna extension cable to extend the antenna to the outside;
- The antenna must not be installed inside the metal case, which will cause the transmission distance to be greatly weakened.

8. FAQ

8.1 Communication range is too short

- The communication distance will be affected when obstacle exists.
- Data lose rate will be affected by temperature, humidity and co-channel interference.
- The ground will absorb and reflect wireless radio wave, so the performance will be poor when testing near ground.
- Sea water has great ability in absorbing wireless radio wave, so performance will be poor when testing near the sea.
- The signal will be affected when the antenna is near metal object or put in a metal case.
- Power register was set incorrectly, air data rate is set as too high (the higher the air data rate, the shorter the distance).
- The power supply low voltage under room temperature is lower than 2.5V, the lower the voltage, the lower the transmitting power.
- Due to antenna quality or poor matching between antenna and module.

8.2 Module is easy to damage

- Please check the power supply source, ensure it is 2.0V~3.6V, voltage higher than 3.6V will damage the module.
- Please check the stability of power source, the voltage cannot fluctuate too much.
- Please make sure antistatic measure are taken when installing and using, high frequency devices have electrostatic susceptibility.
- Please ensure the humidity is within limited range, some parts are sensitive to humidity.
- Please avoid using modules under too high or too low temperature.

8.3 Bit error rate is too high

- There are co-channel signal interference nearby, please be away from interference sources or modify frequency and channel to avoid interference.
- Poor power supply may cause messy code. Make sure that the power supply is reliable
- The extension line and feeder quality are poor or too long, so the bit error rate is high.

9. Production Guidance

9.1 Reflow soldering temperature

Profile Feature	Sn-Pb Assembly	Pb-Free Assembly
Solder Paste	Sn63/Pb37	Sn96.5/Ag3/Cu0.5
Preheat Temperature min (T _{smin})	100°C	150°C
Preheat temperature max (T _{smax})	150°C	200°C
Preheat Time (T _{smin} to T _{smax})(t _s)	60-120 sec	60-120 sec
Average ramp-up rate(T _{smax} to T _p)	3°C/second max	3°C/second max
Liquidous Temperature (TL)	183°C	217°C
Time (t _L) Maintained Above (TL)	60-90 sec	30-90 sec
Peak temperature (T _p)	220-235°C	230-250°C
Average ramp-down rate (T _p to T _{smax})	6°C/second max	6°C/second max
Time 25°C to peak temperature	6 minutes max	8 minutes max

9.2 Reflow soldering curve

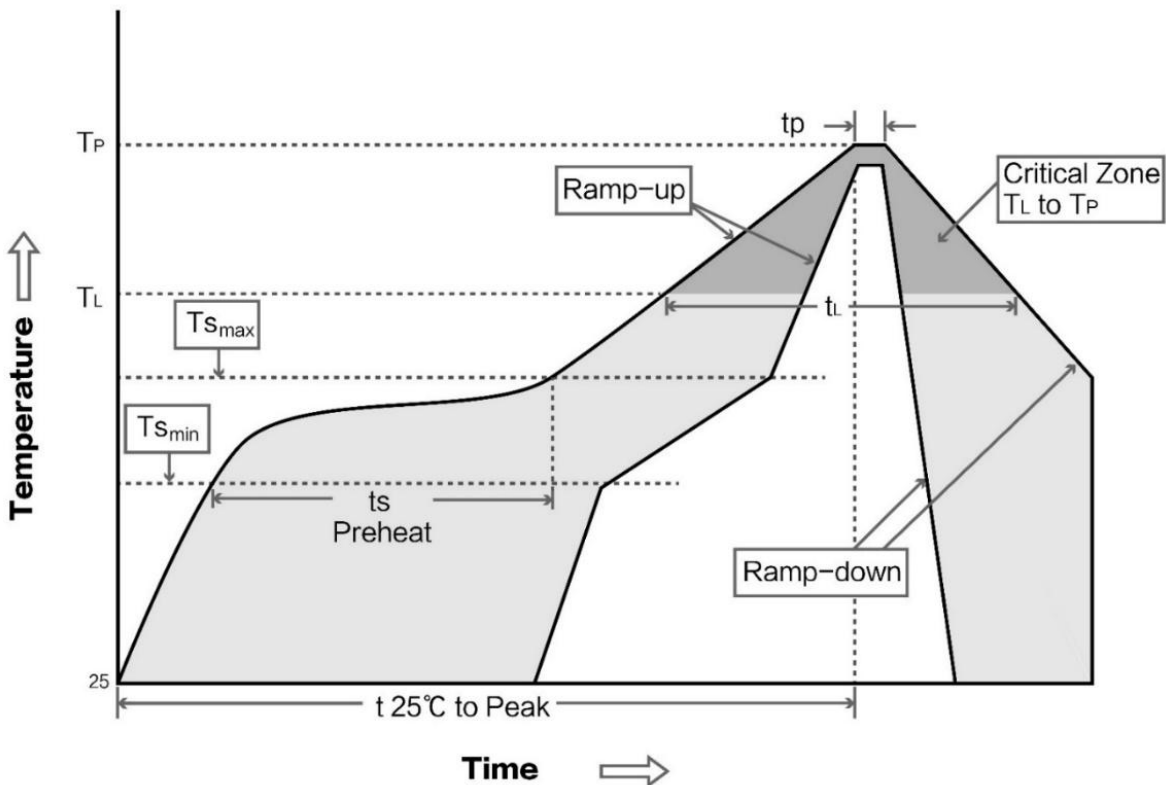

10 Related product

Model NO.	RF IC	Frequency Hz	TX POWER dBm	Interface	Protocol BLE	Size mm	Antenna	Function
E72-2G4M05S1B	CC2640	2.4G	5	I/O	4.2	17.5*28.7	PCB/IPX	Hardware module, requires secondary development
E73-2G4M04S1A	nRF52810	2.4G	4	I/O	4.2/5.0	17.5*28.7	PCB/IPX	Hardware module, requires secondary development
E73-2G4M04S1B	nRF52832	2.4G	4	I/O	4.2/5.0	17.5*28.7	PCB/IPX	Hardware module, requires secondary development
E73-2G4M08S1C	nRF52840	2.4G	8	I/O	4.2/5.0	13*18	PCB/IPX	Hardware module, requires secondary development
E73-2G4M04S1D	nRF51822	2.4G	4	I/O	4.2	17.5*28.7	PCB/IPX	Hardware module, requires secondary development
E104-BT01	CC2541	2.4G	0	I/O	4.0	14*22	PCB	Hardware module, requires secondary development
E104-BT02	DA14580	2.4G	0	TTL	4.2	14*22	PCB	Ultra-low power High speed, sniff
E72-2G4M04S2B	CC2640	2.4G	2	TTL	4.2	14*23	PCB/IPX	Built-in ARM dual core Multiple role
E104-2G4U04A	CC2540	2.4G	0	USB	4.0	18*59	PCB	Dongle Protocol Analyzer
E104-BT5010A	nRF52810	2.4G	0	UART	5.0	11.5 * 16	ceramic antenna	Low power, transparent transmission

11 Package for bulk order

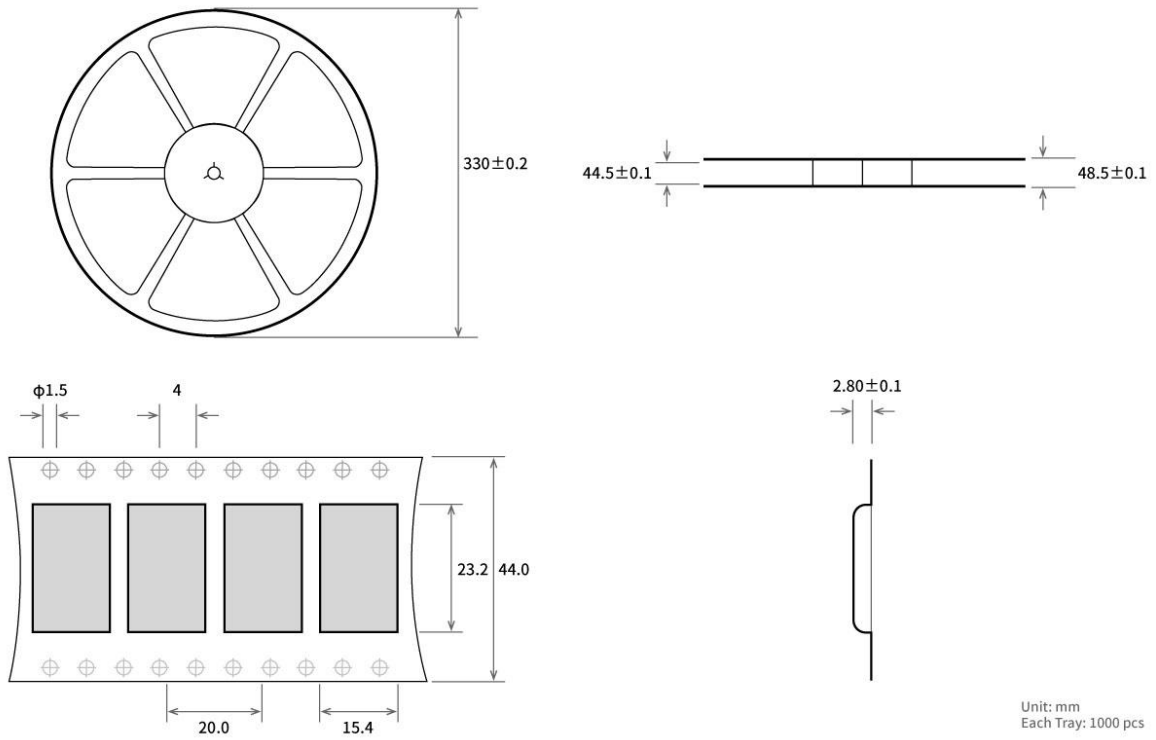

Reversion History

Version	Edit date	Description	Issued by
1.0	2019-5-9	Initial version	huaa
1.1	2019-7-30	Format modification	Lyl
1.2	2022-08-31	Error correction	Bin

About Us



Technical support: support@cdebyte.com;

Documents and RF Setting download link: www.cdebyte.com

Tel: +86-28-61399028 Ext. 812

Fax: 028-64146160

Web: www.cdebyte.com

Address: B5 Mould Park, 199# Xiqu Ave, High-tech District, Sichuan, China

 **Chengdu Ebyte Electronic Technology Co.,Ltd.**