



E810-TTL-CAN01 User Manual

TTL to CAN Intelligent Protocol Conversion Module



Contents

1	Product Overview.....	
1.1	Introduction.....	
1.2	Feature.....	
1.3	Application.....	
2.	Technical Parameters.....	
2.1	Limit parameter.....	
2.2	Operating parameter.....	
3	Size and pin definition	
4	Mode Instructions.....	
4.1	Operating mode.....	
4.2	UART connection.....	
4.3	Data conversion method.....	
4.3	Transparent conversion.....	
4.3.1	Frames in UART converts to CAN message.....	
4.3.2	CAN message converts to frames in UART.....	
4.4	Conversion example (Transparent conversion)	
4.4.1	Frames in UART converts to CAN message.....	
4.4.2	CAN message converts to frames in UART.....	
4.5	Transparent tape identification conversion.....	
4.5.1	Frames in UART converts to CAN message.....	
4.5.2	CAN message converts to frames in UART.....	
4.6	Conversion example (transparent tape identification)	
4.6.1	Frames in UART converts to CAN message.....	
4.6.2	CAN message converts to frames in UART.....	
4.7	Protocol mode.....	
4.8	Conversion example (Protocol mode)	
4.8.1	Frames in UART converts to CAN message.....	
4.8.2	CAN message converts to frames in UART.....	
4.9	ModBus mode.....	
5	Operation Instructions.....	
5.2	Command overview.....	
5.3	Command error code.....	
5.4	Command list.....	
5.4	Command details.....	
5.4.1	AT test command.....	
5.4.2	AT+CANFLT Inquire/set CAN filter info.....	
5.4.3	AT+CAN inquire/set transmitted CAN parameter info.....	
5.4.4	AT+EXAT exit AT command.....	
5.4.5	AT+E inquire/set command echo mode.....	
Function:	inquire/set command echo mode.....	
Format:	inquire.....	
5.4.6	AT+MODBUSID inquire/set MODBUS ID.....	
5.4.7	AT+MODE inquire/set operating mode.....	

5.4.8 AT+MID inquire module name.....	
5.4.9 AT+RESTORE restore factory default setting.....	
5.4.10 AT+REBT reset module.....	
5.4.11 AT+UARTPKT inquire/set UART sub=packing info.....	
5.4.12 AT+UART inquire/set UART parameter.....	
5.4.13 AT+VER inquire module version info.....	
6 Hardware design.....	
7. FAQ.....	
7.1 Module is easy to damage.....	
7.3 Unable to use after parameter is changed.....	
8. Soldering guidance.....	
8.1 Reflow soldering temperature.....	
8.2 Reflow soldering curve.....	
9. Packing.....	
9.1 Anti-statistic pallet.....	
Revision history.....	
About us.....	错误! 未定义书签。

1 Product Overview

1.1 Introduction

E810-TTL-CAN01 is a cost-effective CAN-BUS product with powerful data analysis capabilities. The intelligent protocol conversion module is compact and easy to install. It is a reliable assistant for engineering applications, project debugging and product development.

E810-TTL-CAN01 is independently developed by Chengdu Ebyte Electronic Technology Co., Ltd. It integrates the transparent transmission function, master-slave integration, and is ready to use.

Configuration of module parameters and functions is available via serial port command. Conversion mode supports transparent conversion, transparent tape identification conversion, protocol mode conversion, and Modbus ASCII/RTU protocol conversion.

E810-TTL-CAN01 integrates one channel CAN-BUS interface and one channel UART TTL interface, which can realize mutual transparent transmission or Modbus protocol conversion between UART TTL signal and CAN-BUS. The CAN-TTL-01 is compact and can be powered from any 3.3V or 5V power supply for easy integration into a variety of boards. Half-hole process, with pin welding holes at the same time, can be patched and soldered, and can also be plugged and unplugged.



1.2 Feature

- Bidirectional conversion between UART and CAN is available;
- Conversion mode includes transparent conversion, transparent tape identification conversion and protocol mode conversion;
- Modbus RTU protocol conversion is available;
- Two CAN frame data types transmission methods: fixed configuration and serial frame data designation;
- Parameter configuration via UART interface is available;
- UART baud rate : 300~921600
- Enter parameter setting mode via software and hardware;
- Factory parameters is restored either via software or hardware;
- It contains multiple indications such as a power indicator, status indicator, mode indicator.

1.3 Application

- CAN-BUS networks in Industrial control;
- Auto and railway equipment networking, on-site network data monitoring;
- For existing RS-232 devices to be connected to the CAN-bus network;
- Underground remote communication;
- Security, fire protection network;
- CAN-bus application systems such as Intelligent building control data broadcasting system;
- Parking equipment control;
- Smart home.

2. Technical Parameters

2.1 Limit parameter

Main parameter	Performance		Note
	Min	Max	
Voltage supply (V)	2.3	5.5	Voltage over 5.5V will cause permanent damage to module, 5V and 3.3V are recommended
Operating temperatur (°C)	-40	+85	Industrial grade

2.2 Operating parameter

Category	Items	Value
UART	Baud rate	115200 bps
	Parity	none
	Data bit	8
	Stop bit	1
	Flow Control	off
CAN	CAN baud rate Flow Control	100kbps
	CAN ID	0x00000000
	Flow Control	off
Default operating mode	Transparent transmission mode	Receive all kinds of data
Default device address	Modbus device address	Default device address is 1
Frame sub-packing parameter	Time	10ms
	Byte	1000byte

3 Size and pin definition

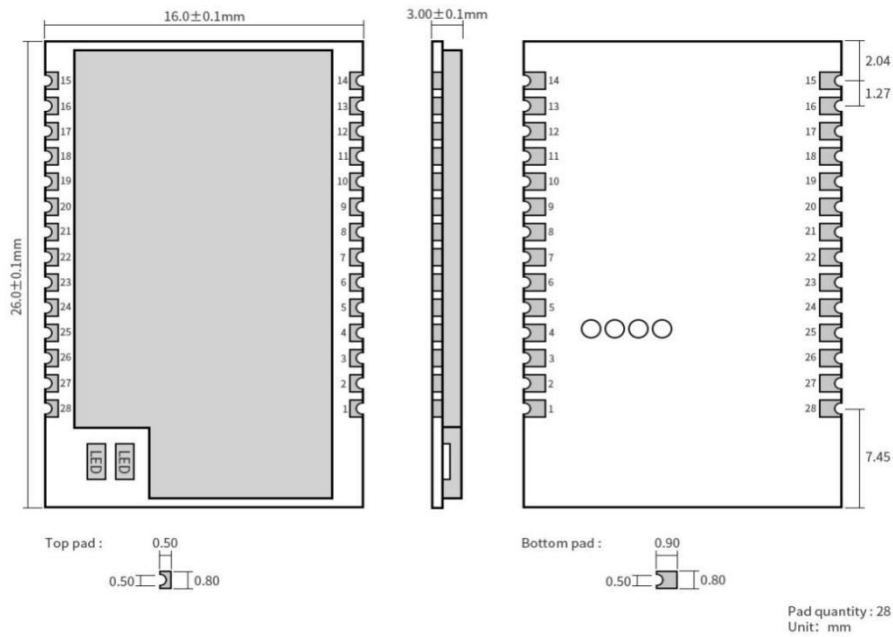

No.	Item	Direction	Application
1	CANH	CAN high	CAN high
2	CANL	CAN low	CAN low
3	GND	Ground	Ground
4	TXD	UART transmit	Module transmits UART data
5	RXD	UART receive	Module receives UART data
6~12	NC	-	-
13	GND	Ground	Ground
14	VCC	Power input	Power input, 5V or 3.3V is recommended
15	GND	Ground	Ground
16	RESET	Reset pin	The module with low level input enters the hardware reset state, and the module with high level input returns to the normal working state. This function is used for reset operation in an emergency.
17	CFG	Hardware parameter setting pin	For parameter setting, it should be connected with GND in short circuit.
18	Restore	Restore default	For restoring , it should be connected with GND in short circuit for 5S. Only valid when reset or power on again.
19~20	NC	-	-
21	STE	State indicator	When there is data transfer, the STE pin is low level
22~25	NC	-	-
26	RTS	Hardware control flow pin	Hardware control flow pin RTS
27	CTS	Hardware control flow pin	Hardware control flow pin CTS
28	GND	Ground	Ground

4 Mode Instructions

4.1 Operating mode

There are two modes for E810-TTL-CAN01, normal and configuration mode.

Mode	Function
Normal	The general mode of the module is normal mode, and it works normally when it is powered on.
Configuration	The mode in which the module can be configured. For details on how to enter the configuration mode, see Chapter 5: Instructions on Entering Command Configuration

4.2 UART connection

The level for E810-TTL-CAN01 is 3.3V, it can be connected to UART interface of MCU directly.

4.3 Data conversion method

- There are four data conversion method: transparent conversion, transparent tape identification conversion, protocol conversion and MODBUS conversion;
- Bidirectional conversion between UART and CAN is available;

Data Conversion Method	Data Conversion Direction
Transparent conversion	Bidirectional conversion between UART and CAN
Transparent tape identification conversion	Bidirectional conversion between UART and CAN
Protocol conversion	Bidirectional conversion between UART and CAN
MODBUS conversion	Bidirectional conversion between UART and CAN

4.3 Transparent conversion

Transparent conversion: The converter converts the bus data of one format to the data format of another bus as it is, without adding data or modifying it. The data format is exchanged without changing the data content. For the bus at both ends, the converter is like "transparent".

The E810-TTL-CAN01 module can convert the valid data received by the CAN bus to the UART, and the UART outputs the same data. Similarly, the module can also convert the data received by the UART to the CAN bus, and realize transparent conversion between UART and CAN.

4.3.1 Frames in UART converts to CAN message

All data in the UART frames is sequentially filled into the data field of the CAN message frame. The converter receives and converts as soon as it detects that there is data on the serial bus. The frame type and frame ID of the converted CAN message come from the user's prior configuration, and the frame type and frame ID remain unchanged during the conversion process. The corresponding format of data conversion is shown as below.

If the received serial frame length is less than or equal to 8 bytes, the characters 1 to n (n is the serial frame length) are sequentially filled into the 1 to n byte position of the data field of the CAN message (as shown in the figure, n is 7).

If the frame length is greater than 8, starting from the first character of the serial frame, for the first time the processor takes 8 characters to fill the data field of the CAN message in turn; after the data is sent to the CAN bus, the conversion is performed. The remaining serial frame data is filled into the data field of the CAN message until its data is completely converted.

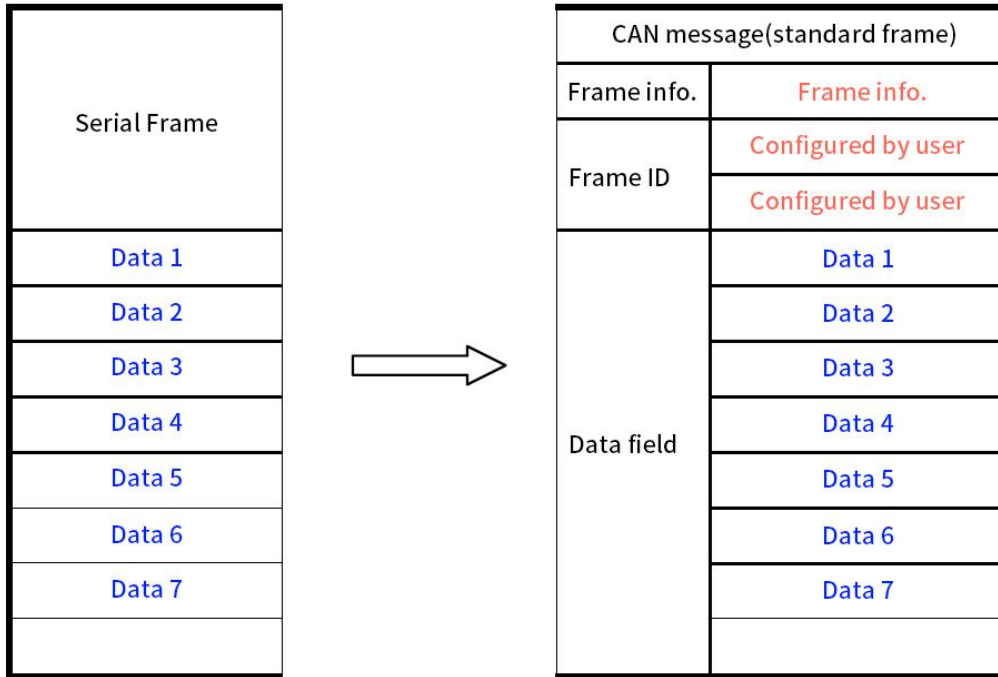

4.3.2 CAN message converts to frames in UART

All data in the data field of the CAN message frame is sequentially filled into the serial frame data; the converter receives and converts immediately after detecting the data on the CAN bus.

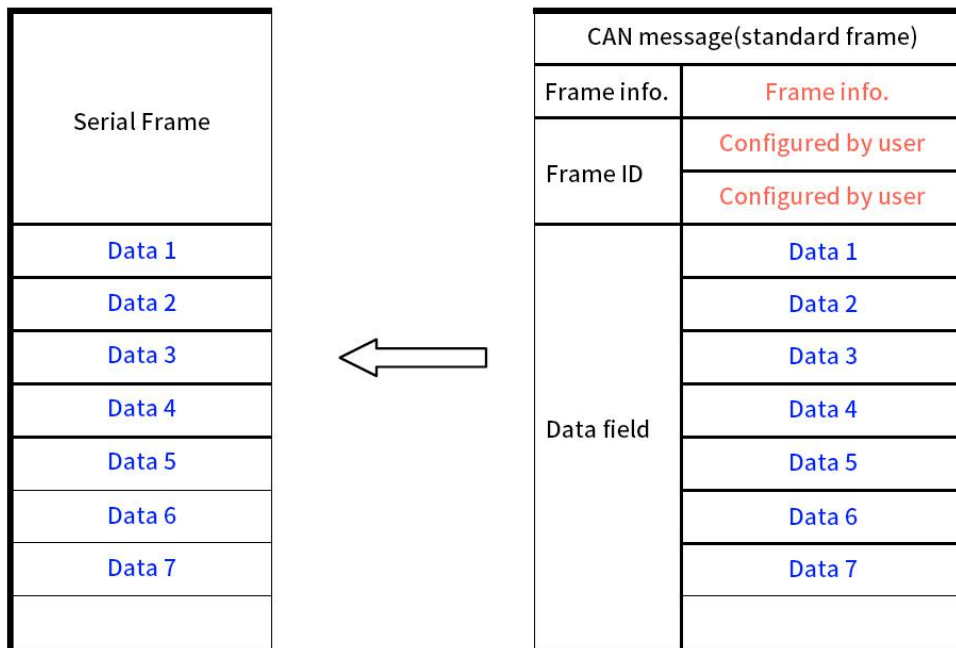

4.4 Conversion example (Transparent conversion)

4.4.1 Frames in UART converts to CAN message

Assume that the frame information converted into CAN message is "standard frame" and the frame ID (ID1, ID2) is set to 0060, then the conversion format is as shown in the figure below.

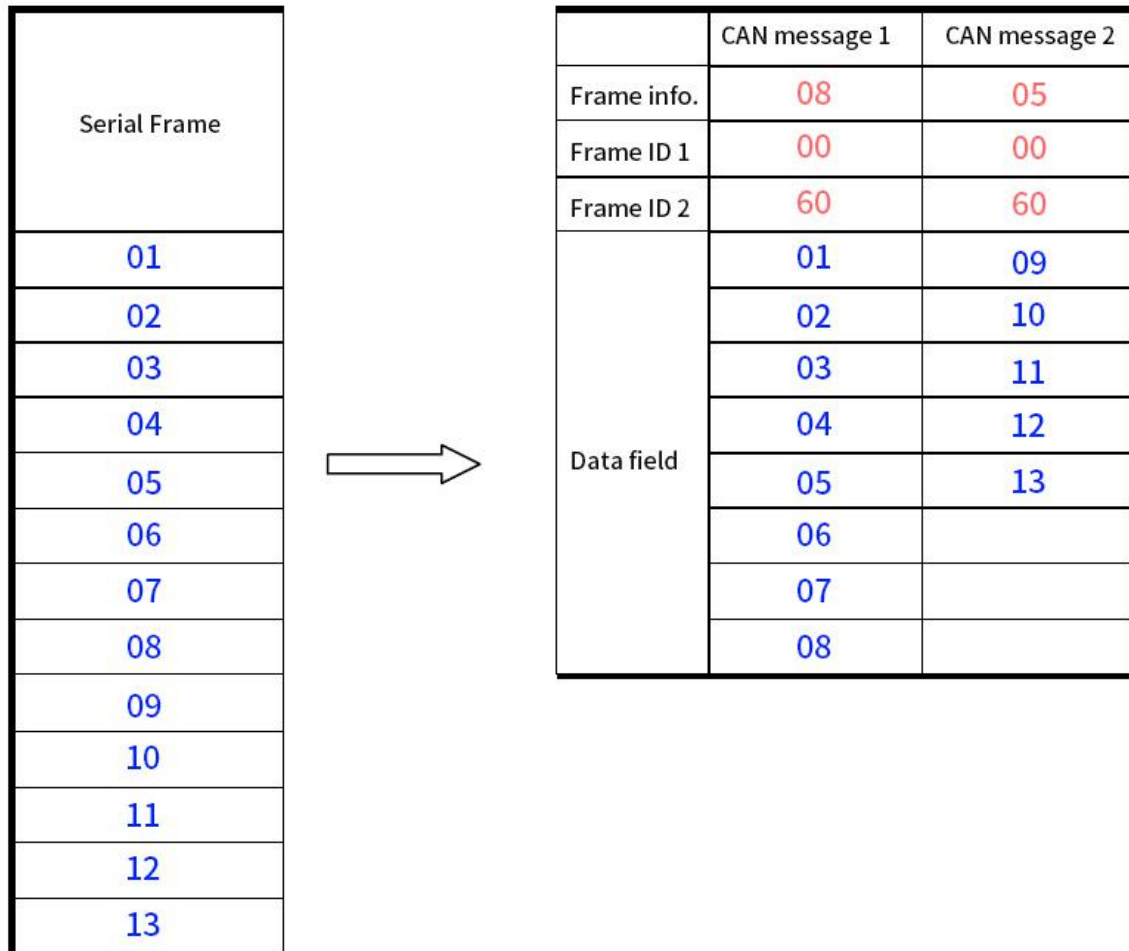

4.4.2 CAN message converts to frames in UART

Assume that the frame information of CAN message is "standard frame" and the frame ID (ID1, ID2) is set to 0060, then the conversion format is as shown below.

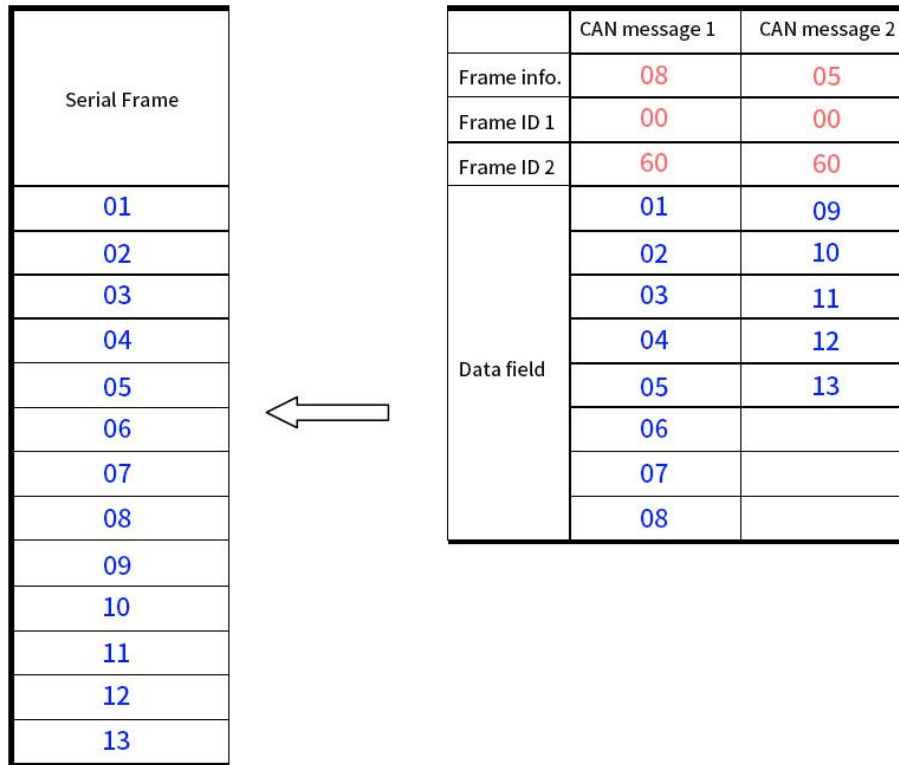

4.5 Transparent tape identification conversion

Transparent tape identification conversion is a special use of transparent conversion without any protocol attached. This conversion method is based on the common characteristics of the usual serial frame and CAN message, so that the two different bus types can easily form a same communication network.

In this mode, the CAN bus receiver can add the received frame information of the CAN message and the frame ID to the converted serial frame. In this way, the receiver can clearly see the sender's CAN message to ensure more flexible use.

4.5.1 Frames in UART converts to CAN message

With the transparent conversion, all the data of the serial frame is sequentially filled into the data field of the CAN message frame. The converter receives and converts as soon as it detects that there is data on the serial bus.

The frame type and frame ID of the converted CAN message come from the user's prior configuration, and the frame type and frame ID remain unchanged during the conversion process. The corresponding format of data conversion is shown in Figure 4.1.

If the received serial frame length is less than or equal to 8 bytes, the characters 1 to n (n is the serial frame

length) are sequentially padded to the 1 to n byte position of the data field of the CAN message (as shown in the figure, n is 8).

If the number of bytes of the serial frame is greater than 8, starting from the first character of the serial frame, for the first time the processor takes 8 characters to fill the data field of the CAN message in turn; The data is sent to the CAN bus before the conversion is performed. The remaining serial frame data is filled into the data field of the CAN message until its data is completely converted.

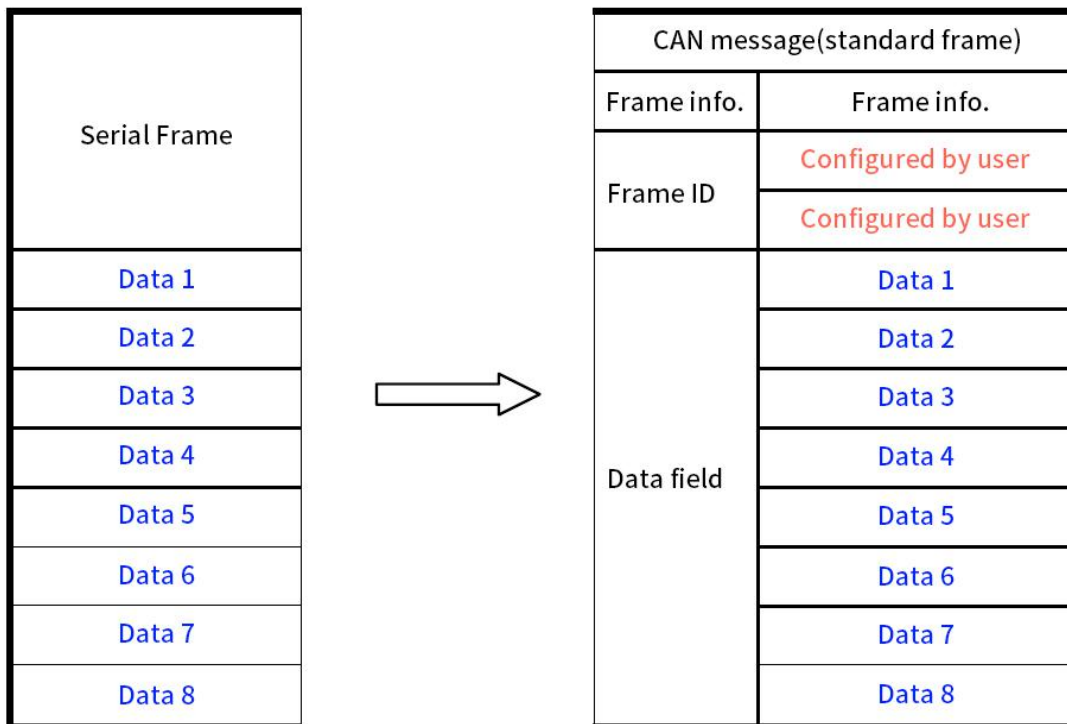

4.5.2 CAN message converts to frames in UART

Once data is detected on the CAN bus via the converter, it is immediately received and converted. When the converter receives a frame of CAN message, the frame is immediately converted. Whenever the conversion, the CAN frame information and the frame ID are added to the serial frame. The conversion is the same as the CAN message to serial frame of the following protocol mode. For details, please refer to the protocol mode), as shown in the figure below.

Please note: whether the serial frame or CAN message is applied at the time of its frame format (standard frame or extended frame) should meet the previously configured frame format requirements, otherwise communication may fail.

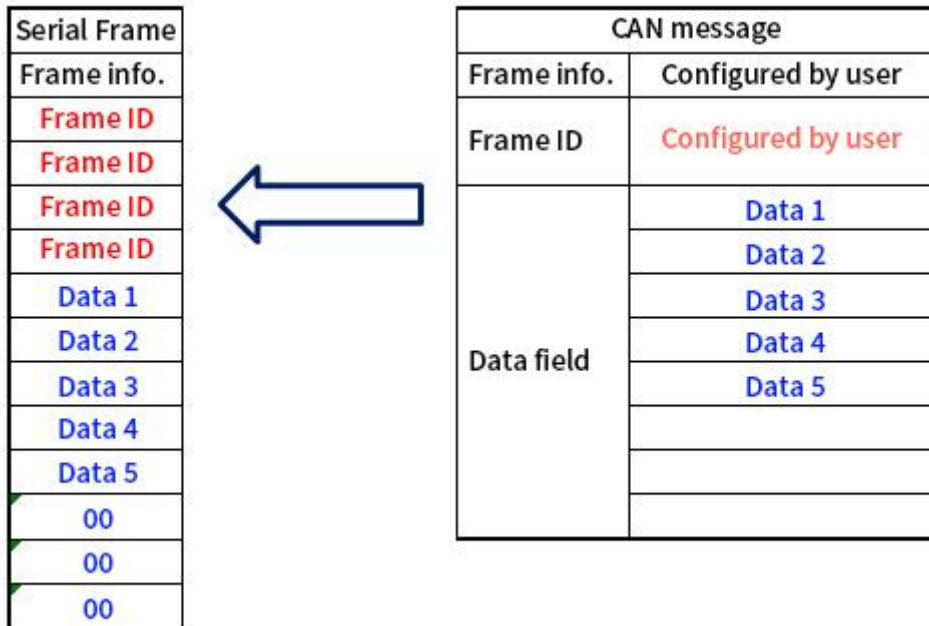

4.6 Conversion example (transparent tape identification)

4.6.1 Frames in UART converts to CAN message

Assume that the frame information converted into CAN message is "standard frame" and the frame ID (ID1, ID2) is set to 0060, then the conversion format is as shown in the figure below.

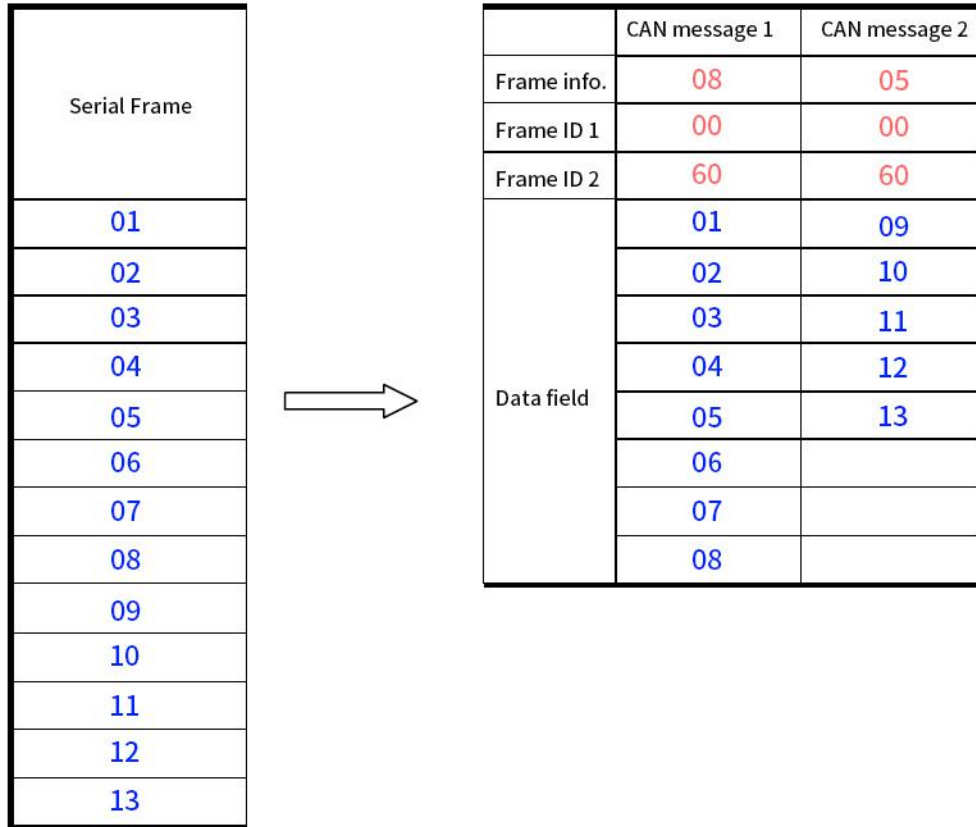

4.6.2 CAN message converts to frames in UART

CAN transmit:

Frame format: extension frames

Frame type: data frames

ID : 0x12345678

Data : AAh BBh CCh DDh EEh

Frames in UART receive: 85 12 34 56 78 AA BB CC DD EE 00 00 00

0x85 indicates that the frame format is an extended frame, the frame type is a data frame, and the data length is 5

The last four digits indicate that the CAN ID is 12345678.

The last 8 bits are the data area, the effective length is 5, and the remaining bits are filled with 0.

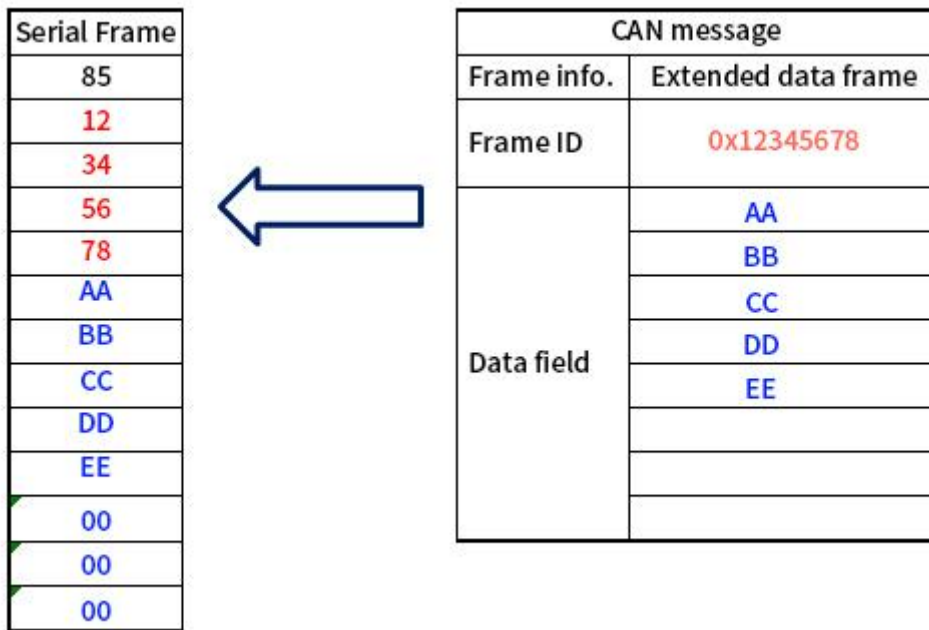

4.7 Protocol mode

The data conversion format of E810-TTL-CAN01 module is as follows. Each CAN frame contains 13 bytes, and the 13-byte contents include CAN frame information + frame ID + frame data.

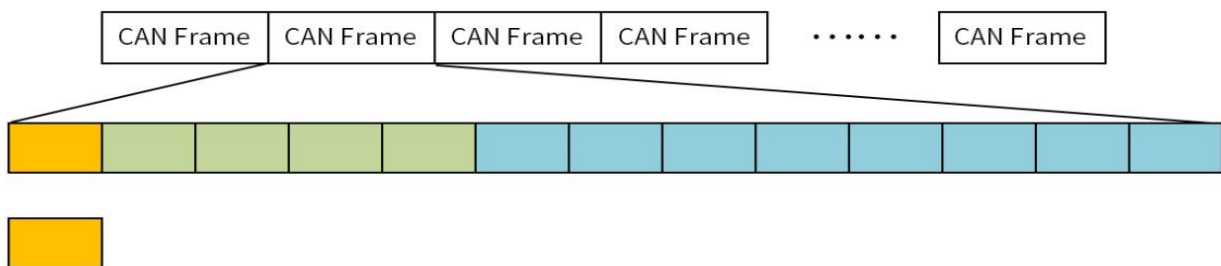

Frame info. length: 1 byte, for indicating some info of can frame such as type, length.



FF: Indicator of standard and extended frame, 1 means extended frame, 0 means standard frame.

RTR: Indicator of remote frame and data frame, 1 means remote frame, 0 means data frame.

N/A: Value is 0. Cannot put in 1.

D3~D0: Data length bit for indicating data length of CAN frame.

 **Frame ID:** length of 4 bytes, valid bit for standard frame is 11 bits, valid bit for extension frame is 29 bits

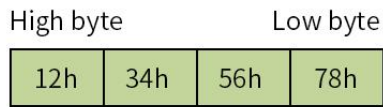

Above is extended ID
In form of 0x12345678

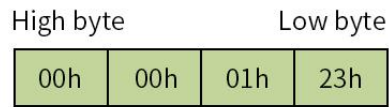

Above is standard ID
In form of 0x123

 **Frame data:** length of 8 bytes, valid length depends on value of D3~D0.

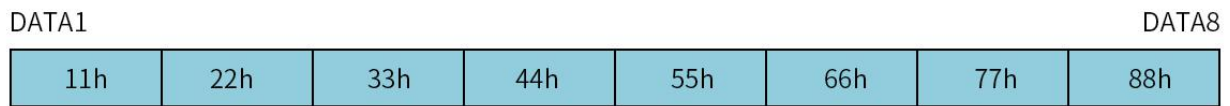

Above is the form for 8 bytes of valid data.

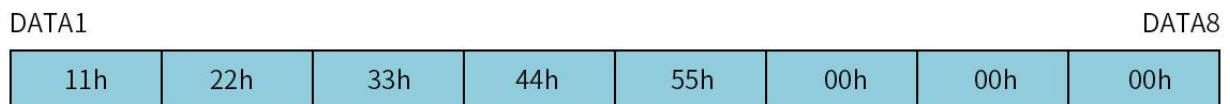

Above is the form for 5 bytes of valid data.

For example:

This is the form for 8 bytes of valid data (11h,22h,33h,44h,55h,66h,77h,88h) as show below. It is a extended frame and frame ID is 0x12345678.



This is the form for 5 bytes of valid data (11h,22h,33h,44h,55h) as show below. It is a standard frame and frame ID is 0x123.



Please note: Every frame contains 13 bytes, 0 must be added when it is less than 13 bytes or communication error will happen.

4.8 Conversion example (Protocol mode)

4.8.1 Frames in UART converts to CAN message

Frames in UART transmit: 05 00 00 06 78 12 34 56 78 90 00 00 00

0x05 indicates that the frame format is a standard frame, the frame type is a data frame, and the data length is 5.

00 00 06 78 indicates ID is 0678

12 34 56 78 90 00 00 00 is data field, valid length is 5, as shown below:

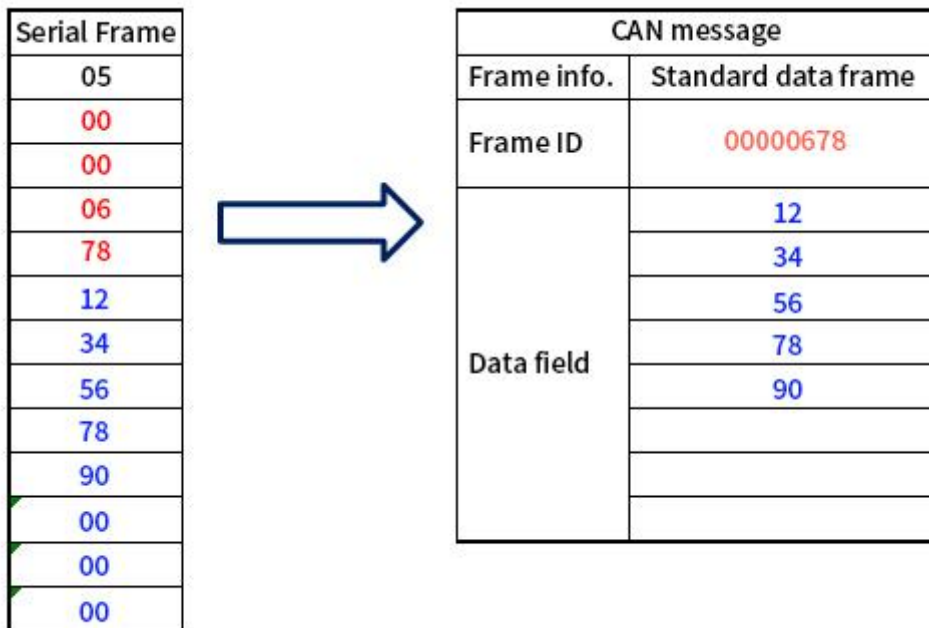

4.8.2 CAN message converts to frames in UART

CAN transmits:

Frame format: extension frames

Frame type: data frames

ID : 0x12345678

Data : AAh BBh CCh DDh EEh

Frames in UART receives: 85 12 34 56 78 AA BB CC DD EE 00 00 00

0x85 indicates that the frame format is an extended frame, the frame type is a data frame, and the data length is 5

The last four digits indicate that the CAN ID is 12345678.

The last 8 bits are the data area, the effective length is 5, and the remaining bits are filled with 0, as shown below,

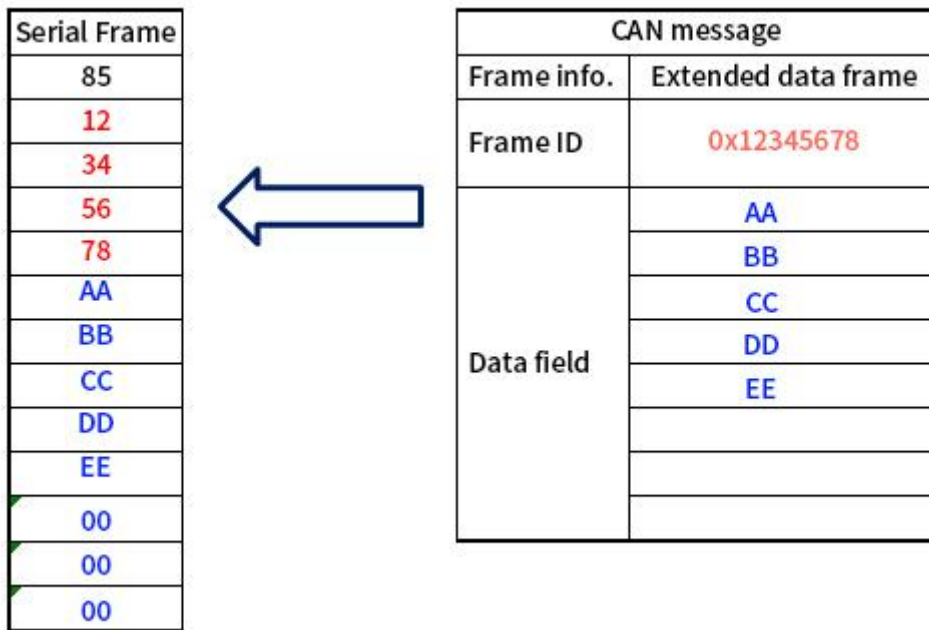

4.9 ModBus mode

Modbus conversion mode supports RTU conversion mode. The E810-TTL-CAN01 module is used as a slave device to receive and respond to commands sent by the host (via the UART).

The E810-TTL-CAN01 conversion module supports two Modbus commands: read register (function code 03) and write multiple registers (function code 16).

A buffer is internally built in the conversion module for buffering the received CAN frame data, and the buffer has a total of 64 levels of buffer according to the addresses 0~63. The cache address starts from 0 to address 63, and can continuously buffer 8 frames of CAN data (8 bytes per frame, a total of 64 bytes). When the first frame of CAN data is received, the CAN frame data is stored in address 0, and the received CAN frame data is sequentially stored in increasing order according to the address. If the 64-level cache is full, the newly received CAN frame data will be stored in address 0 and overwrite the original number, following FIFO.

Read register (function code 03):

Send command:

[Device Address] [Command No. 03 (0x03)] [Start Register Address is 8 Bits High] [8 Bits Low] [Read Register Numbers is 8 Bits High] [8 Bits Low]
 [High 8 bits of CRC check] [Lower 8 bits of CRC check]

The read format is only allowed to read 00 08 from address 00 00 (one byte of data is read at a time, that is, data of 00 00 – 00 07 address is read), after reading successfully, the 8 The byte data will be emptied, and the data after its address will move forward by 8 data.

such as:

When the module in MODBUS mode, the CAN bus receives 4 frames of data:

First frame: 0x01 0x02 0x03 0x04 Total: 4 bytes of data

Second frame: 0x0A 0x0B 0x0C 0x0D 0x0E 0x0F Total: 6 bytes of data

Third frame: 0x11 0x22 0x33 0x44 0x55 0x66 0x77 0x88 Total:8 bytes of data

Fourth frame: 0XAA 0XBB 0XCC Total: 3 bytes of data

They are stored in the MODBUS cache address:

(The address without data is 0x00)

Buffer Add	Data
0x31	0x00
0x30	0x00
0x29	0x00
0x28	0x00
0x27	0x00
0x26	0xCC
0x25	0xBB
0x24	0xAA
0x23	0x88
0x22	0x77
0x21	0x66
0x20	0x55
0x19	0x44
0x18	0x33
0x17	0x22
0x16	0x11
0x15	0x00
0x14	0x00
0x13	0x0F
0x12	0x0E
0x11	0x0D
0x10	0x0C
0x09	0x0B
0x08	0x0A
0x07	0x00
0x06	0x00
0x05	0x00
0x04	0x00
0x03	0x04
0x02	0x03
0x01	0x02
0x00	0x01

Buffer Add	Data
0x63	0x00
0x62	0x00
0x61	0x00
0x60	0x00
0x59	0x00
0x58	0x00
0x57	0x00
0x56	0x00
0x55	0x00
0x54	0x00
0x53	0x00
0x52	0x00
0x51	0x00
0x50	0x00
0x49	0x00
0x48	0x00
0x47	0x00
0x46	0x00
0x45	0x00
0x44	0x00
0x43	0x00
0x42	0x00
0x41	0x00
0x40	0x00
0x39	0x00
0x38	0x00
0x37	0x00
0x36	0x00
0x35	0x00
0x34	0x00
0x33	0x00
0x32	0x00

With the command: 01 03 00 00 00 08 (in the slave device with address 01, read 8 data starting from address 0000) Write this command to the special tool (Modbus CRC 16 calculator) to calculate the CRC check. The value is added after the instruction. This command is issued via the UART: 01 03 00 00 00 08 44 0C. When the slave receives the instruction, it returns the buffer value inside the slave conversion module. (When no new CAN frame data is received, the cache value read by the host is all 0)

Return instruction:

[Device Address] [Command No. 03] [Number of Bytes Returned] [Data 1] [Data 2]...[Data n] [High 8 bits of CRC check] [Low 8 bits of CRC check]

Such as:

Once the slave receives instruction 01 03 00 00 00 08 44 0C, it returns:

01 03 10 00 01 00 02 00 03 00 04 00 00 00 00 00 00 00 00 00 1F 9F

After the reading is completed, the 8 bytes of data are emptied, and the data after the address is moved forward by 8 data. As shown below:

Buffer Add	Data	Buffer Add	Data
0x31	0x00	0x63	0x00
0x30	0x00	0x62	0x00
0x29	0x00	0x61	0x00
0x28	0x00	0x60	0x00
0x27	0x00	0x59	0x00
0x26	0xCC	0x58	0x00
0x25	0xBB	0x57	0x00
0x24	0xAA	0x56	0x00
0x23	0x88	0x55	0x00
0x22	0x77	0x54	0x00
0x21	0x66	0x53	0x00
0x20	0x55	0x52	0x00
0x19	0x44	0x51	0x00
0x18	0x33	0x50	0x00
0x17	0x22	0x49	0x00
0x16	0x11	0x48	0x00
0x15	0x00	0x47	0x00
0x14	0x00	0x46	0x00
0x13	0x0F	0x45	0x00
0x12	0x0E	0x44	0x00
0x11	0x0D	0x43	0x00
0x10	0x0C	0x42	0x00
0x09	0x0B	0x41	0x00
0x08	0x0A	0x40	0x00
0x07	0x00	0x39	0x00
0x06	0x00	0x38	0x00
0x05	0x00	0x37	0x00
0x04	0x00	0x36	0x00
0x03	0x04	0x35	0x00
0x02	0x03	0x34	0x00
0x01	0x02	0x33	0x00
0x00	0x01	0x32	0x00

This allows to read register command for the next time

Write multiple registers (function code 16): When writing successfully, the written data will be sent to the CAN bus.

Send command:

[Device Address] [Command No. 16 (0x10)] [The lower register address is required to be 8 bits high] [Low 8 bits] [The number of data is high 8 bits] [The number of data is lower 8 bits] [The lower data is 8 bits higher] [Low 8 bits] [...] [...] [High 8 bits of CRC check] [Low 8 bits of CRC check]

Such as:

Write 5 bytes of data by writing a command: 01 10 00 00 00 05 0A 00 11 00 22 00 33 00 44 00 55 , write this instruction to the special tool (Modbus CRC 16 calculator), calculate the CRC check value And added to the instruction: 01 10 00 00 00 05 0A 00 11 00 22 00 33 00 44 00 55 47 84, sent in HEX format, 5 bytes of data will be written. When written successfully, the data is sent to the CAN bus, ie the CAN bus will send 5 bytes of data: 11, 22, 33, 44, 55. In the CAN message, the frame information and the frame ID are configured by the user in advance.

Note: The register address of this command is only allowed to be 00 00 and is not allowed to be sent in format as follows: 01 10 00 01 00 05 0A 00 11 00 22 00 33 00 44 00 55

And send up to 8 bytes of data at a time:

Write 8 bytes of data by writing a command: 01 10 00 00 00 08 10 00 11 00 22 00 33 00 44 00 55 00 66 00 77 00 88, write this command to a special tool (Modbus CRC 16 calculator), Calculate the CRC check value and add it to the instruction: 01 10 00 00 00 08 10 00 11 00 22 00 33 00 44 00 55 00 66 00 77 00 88 FE D5, sent in HEX format, can write 8 bytes Data, when successfully written, will send the written data to the CAN bus, that is, the CAN bus will send 8 bytes of data: 0x11, 0x22, 0x33, 0x44, 0x55, 0x66, 0x77, 0x88. In the CAN message, the frame information and the frame ID are configured by the user in advance.

It is not allowed to send in an instruction format.as follows: 01 10 00 00 00 09 12 00 11 00 22 00 33 00 44 00 55 00 66 00 77 00 88 00 99

5 Operation Instructions

5.1 Entering Command Configuration Instructions

Note: In the normal working mode, the mode indicator flashes at 1Hz frequency; when entering the command configuration mode, the indicator light flashes at 5Hz frequency. Whether it is software entry or hardware entry, the configured parameters are valid after reset.

There are two ways to enter the command configuration mode:

1 Switching from other modes to command mode (software entry):

The serial device continuously sends "+++" to the module. After the module receives "+++", the 3 second timer expires and starts to start. If any AT command is received within the timeout period, it will successfully switch to the configuration mode (after entering, The module indicator flashes at a frequency of 5 Hz).

At this point, the parameters can be configured. For the parameter list and parameter description, please refer to the following.

After the parameter configuration is successful, the serial device sends the command "AT+ EXAT" to the module. After receiving the command, the module returns "+OK" and exits the configuration mode and returns to the pre-configuration mode. Then short-circuit the reset RESET pin and the parameters take effect. It is also possible to reset the module with the command "AT+REBT" after successful configuration with the AT command parameters.

2 Switching from other modes to command mode (hardware entry):

Short-circuit the CFG pin to GND to enter the configuration mode directly. (After entering, the module indicator flashing frequency becomes 5Hz. During the configuration process, the CFG pin must be kept low for all times.) Send the AT command directly for configuration. After shorting and shorting, short reset the RESET pin and the parameters take effect.

Remark: Both the hardware entry command mode and the exit command mode have higher priority than the software command entry command mode.

For example, first use the software command to enter the command mode, and then short the CFG pin to GND. Because the hardware priority is high, it is now regarded as the hardware entry command mode. When the CFG pin goes high, it is directly the hardware exit. Command mode.

5.2 Command overview

The AT command refers to the instruction set that the user transmits commands through the UART and the module in the command mode. The format of the AT command is explained in detail later. After power-on, switch to configuration mode and set the module through UART.

Timing for switching from transparent mode to command mode:

The serial device continuously sends "+++" to the module. After the module receives "+++", the 3 second timer expires and starts to start. If any AT command is received within the timeout period, the switch is successfully switched to the configuration mode.

Finally, the serial device sends the command "AT+ EXAT" to the module. After receiving the command, the module returns "+OK" and exits the configuration. Then short-circuit the reset RESET pin and the parameters take effect. It is also possible to reset the module with the command "AT+REBT" after successful configuration with the AT command parameters.

Note: After the parameters are configured, the parameters must be valid after the reset.

Description: <CR>: ASCII code 0x0D

<LF>: ASCII code 0x0A

5.3 Command error code

Error code	Description
-1	Invalid command format
-2	Invalid command
-3	Invalid operator
-4	Invalid parameter
-5	Operation not allowed

5.4 Command list

AT	Test command
CANFLT	Inquire/set CAN filter info.
CAN	Inquire/set CAN transmit parameter info.
EXAT	Exit AT command
E	Inquire/set AT command echo
MODBUSID	Inquire/set MODBUS ID

MODE	Inquire/set operating mode
MID	Inquire device info.
RESTORE	Restore factory default
REBT	Reset command
UARTPKT	Inquire/set UART sub-packing parameter
UART	Inquire/set UART parameter
VER	Inquire/set version

5.4 Command details

5.4.1 AT test command

Function: test command

Format: Set

Transmit: AT<CR>

Return: <CR><LF>+OK<CR><LF>

Example: AT<CR>

5.4.2 AT+CANFLT Inquire/set CAN filter info.

Function: Inquire/set CAN filter info.

Format: inquire

Transmit: AT+CANFLT<CR>

Return: <CR><LF>+OK=<id,mask id,mode><CR><LF>

Set

Transmit: AT+ CANFLT =<id,mask id,mode><CR>

Return: <CR><LF>+OK<CR><LF>

Parameter:

id: filter id, work with filter mask id, this parameter takes effect only in user-defined filtering mode.

mask id: filter mask id, work with id, this parameter takes effect only in user-defined filtering mode

mode: filtering mode 8 modes in total: OFF receive all kinds of frame

EDTF Receive extending data frame only

ERTF Receive extending remote frame only

NRTF Receive standard remote frame only

NDTF Receive standard data frame only

ETF Receive extending frame only

NTF Receive standard frame only

USRF User-defined filter mode (ie standard CAN identifier mask bit mode, please refer to the CAN related data for reference, you need to set the identifier match value (ie the id in the parameter), and the mask code (ie the mask id in the parameter))

Example: AT+CANFLT=0,0,OFF <CR>

5.4.3 AT+CAN inquire/set transmitted CAN parameter info.

Function: inquire/set transmitted CAN parameter info.

Format: Inquire

Transmit: AT+CAN<CR>

Return: <CR><LF>+OK=<baud,id,mode><CR><LF>

Set

Transmit: AT+ CAN

Return: <CR><LF>+OK<CR><LF>

Parameter:

baud: CAN baud rate unit: kbps range: 6, 10, 20, 50, 100, 120, 125, 150, 200, 250, 400, 500, 600, 750, 1000

id: transmitted frame ID (identifier) NDTF mode: 0-7FF EDTF mode: 0-1FFFFFFF

mode: transmitting mode 2 modes in total: NDTF transmitted standard data frame

EDTF transmit extending data frame

Example: AT+CAN=100,70,NDTF <CR>

5.4.4 AT+EXAT exit AT command

Function: exit AT command

Format: Set

Transmit: AT+EXAT<CR>

Return: <CR><LF>+OK<CR><LF>

Example: AT+EXAT<CR>

5.4.5 AT+E inquire/set command echo mode

Function: inquire/set command echo mode

Format: inquire

Transmit: AT+E<CR>

Return: <CR><LF>+OK=<sw><CR><LF>

Set

Transmit: AT+E=<sw><CR>

Return: <CR><LF>+OK<CR><LF>

Parameter:

sw AT command echo switch 2 status in total:

ON turn on echo, echo inputted command in AT command

OFF turn off echo, command is not echoed in AT command

Example: AT+E=ON<CR>

5.4.6 AT+MODBUSID inquire/set MODBUS ID

Function: inquire/set MODBUS ID

Format: inquire

Transmit: AT+ AT+MODBUSID <CR>

Return: <CR><LF>+OK=<id><CR><LF>

Set

Transmit: AT+ AT+MODBUSID =<id><CR>

Return: <CR><LF>+OK<CR><LF>

Parameter:

id: MODBUS ID range: 0-255

Example: AT+MODBUSID=9 <CR>

5.4.7 AT+MODE inquire/set operating mode

Function: inquire/set operating mode

Format: inquire

Transmit: AT+MODE <CR>

Return: <CR><LF>+OK=<mode><CR><LF>

Set

Transmit: AT+MODE =<mode><CR>

Return: <CR><LF>+OK<CR><LF>

Parameter:

Mode: operating mode 4 in total:
 TRANS transparent transmission mode
 TPRTL transparent tape information mode
 MODBUS MODBUS mode
 PROTOl protocol mode

Example: AT+MODE=TRANS <CR>

5.4.8 AT+MID inquire module name

Function: inquire module name

Format: inquire

Transmit: AT+MID<CR>

Return: <CR><LF>+OK=<name><CR><LF>

Parameter: name module name

Example: AT+MID=E810-TTL<CR>

5.4.9 AT+RESTORE restore factory default setting

Function: restore factory default setting

Format: set

Transmit: AT+RESTORE<CR>

Return: <CR><LF>+OK<CR><LF>

Parameter: none

Example: AT+ RESTORE <CR>

<Note>: After successfully complete this command, send AT+REBT to restore

5.4.10 AT+REBT reset module

Function: reset module

Format: Set

Transmit: AT+REBT<CR>

Return: <CR><LF>+OK<CR><LF>

Parameter: none

Example: AT+ REBT <CR>

<Note>: After successfully complete this command, send module is reset and will exit AT command.

5.4.11 AT+UARTPKT inquire/set UART sub=packing info.

Function: inquire/set UART sub=packing info.

Format: inquire

Transmit: AT+UARTPKT<CR>

Return: <CR><LF>+OK=<size,time><CR><LF>

Set

Transmit: AT+ UARTPKT=<size,time><CR>

Return: <CR><LF>+OK<CR><LF>

Parameter:

Size The length of the package, 0,4-1000 bytes, 0 is off, both are 0 , it is default packaging parameters

Time packing time, 0,10~1000 ms, 0 is off, both are 0 , it is default packing parameter

Example: AT+UARTPKT=1000,10<CR>

5.4.12 AT+UART inquire/set UART parameter

Function: inquire/set UART parameter

Format: inquire

Transmit: AT+UART<CR>

Return: <CR><LF>+OK=<baud,data,stop,parity,flowctrl><CR><LF>

Set

Transmit: AT+UART=<baud,data,stop,parity,flowctrl><CR>

Return: <CR><LF>+OK<CR><LF>

Parameter:

baud baud rate, from 300-921600

data data bit 8

stop stop bit 1、 2

parity ODD (odd) 、 EVEN (even) 、 NONE (none)

flowctrl flow control bit NFC (without flow control) 、 FC (with flow control)

Example: AT+UART=9600,8,1,NONE,NFC<CR>

5.4.13 AT+VER inquire module version info.

Function: inquire module version info.

Format: inquire

Transmit: AT+VER<CR>

Return: <CR><LF>+OK=<ver><CR><LF>

Parameter:

ver version number

Example: AT+VER<CR>

6 Hardware design

- It is recommended to use a DC stabilized power supply. The power supply ripple factor is as small as possible, and the module needs to be reliably grounded ;
- Please pay attention to the correct connection of the positive and negative poles of the power supply. Reverse connection may cause permanent damage to the module ;
- Please check the power supply to ensure it is within the recommended voltage otherwise when it exceeds the maximum value the module will be permanently damaged;
- Please check the stability of the power supply, the voltage cannot be fluctuated frequently ;
- When designing the power supply circuit for the module, it is often recommended to reserve more than 30% of the margin, so the whole machine is beneficial for long-term stable operation;
- The module should be as far away as possible from the power supply, transformers, high-frequency wiring and other parts with large electromagnetic interference;
- High-frequency digital routing, high-frequency analog routing, and power routing must be avoided under the module. If it is necessary to pass through the module, assume that the module is soldered to the Top Layer, and the copper is spread on the Top Layer of the module contact part(well grounded), it must be close to the digital part of the module and routed in the Bottom Layer ;
- Assuming the module is soldered or placed over the Top Layer, it is wrong to randomly route over the Bottom Layer or other layers, which will affect the module's spurs and receiving sensitivity to varying degrees ;
- It is assumed that there are devices with large electromagnetic interference around the module that will greatly affect the performance. It is recommended to keep them away from the module according to the strength of the interference. If necessary, appropriate isolation and shielding can be done ;
- Assume that there are traces with large electromagnetic interference (high-frequency digital, high-frequency analog, power traces) around the module that will greatly affect the performance of the module. It is recommended to stay away from the module according to the strength of the interference. If necessary, appropriate isolation and shielding can be done.

7. FAQ

7.1 Module is easy to damage

- Please check the power supply, ensure it is incorrect range, otherwise, module will be damaged.
- Please check the stability of power supply, the voltage cannot fluctuate too much.
- Please make sure antistatic measure are taken when installing and using.
- Please ensure the humidity is within limited range, some parts are sensitive to humidity.
- Please avoid using modules under too high or too low temperature.

7.2 Unable to successfully set the command

- Please check if the instruction format is correct.

- Please check the flashing frequency of the indicator light. When the command is configured, the indicator blinks at 5Hz
- Please check the mode used by the instruction.

7.3 Unable to use after parameter is changed

- Please check if the serial port baud rate and CAN baud rate are set correctly.
- Please check if the data format is in compliance.
- Please check if the computer serial port is halted.
- Please read the instruction manual carefully.

8. Soldering guidance

8.1 Reflow soldering temperature

Profile Feature	Curve characteristics	Sn-Pb Assembly	Pb-Free Assembly
Solder Paste	Solder paste	Sn63/Pb37	Sn96.5/Ag3/Cu0.5
Preheat Temperature min (T _{smin})	Min preheating temp.	100°C	150°C
Preheat temperature max (T _{smax})	Mx preheating temp.	150°C	200°C
Preheat Time (T _{smin} to T _{smax})(t _s)	Preheating time	60-120 sec	60-120 sec
Average ramp-up rate(T _{smax} to T _p)	Average ramp-up rate	3°C/second max	3°C/second max
Liquidous Temperature (TL)	Liquid phase temp.	183°C	217°C
Time (t _L) Maintained Above (TL)	Time below liquid phase line	60-90 sec	30-90 sec
Peak temperature (T _p)	Peak temp.	220-235°C	230-250°C
Aveage ramp-down rate (T _p to T _{smax})	Average ramp-down rate	6°C/second max	6°C/second max
Time 25°C to peak temperature	Time to peak temperature for 25°C	6 minutes max	8 minutes max

8.2 Reflow soldering curve

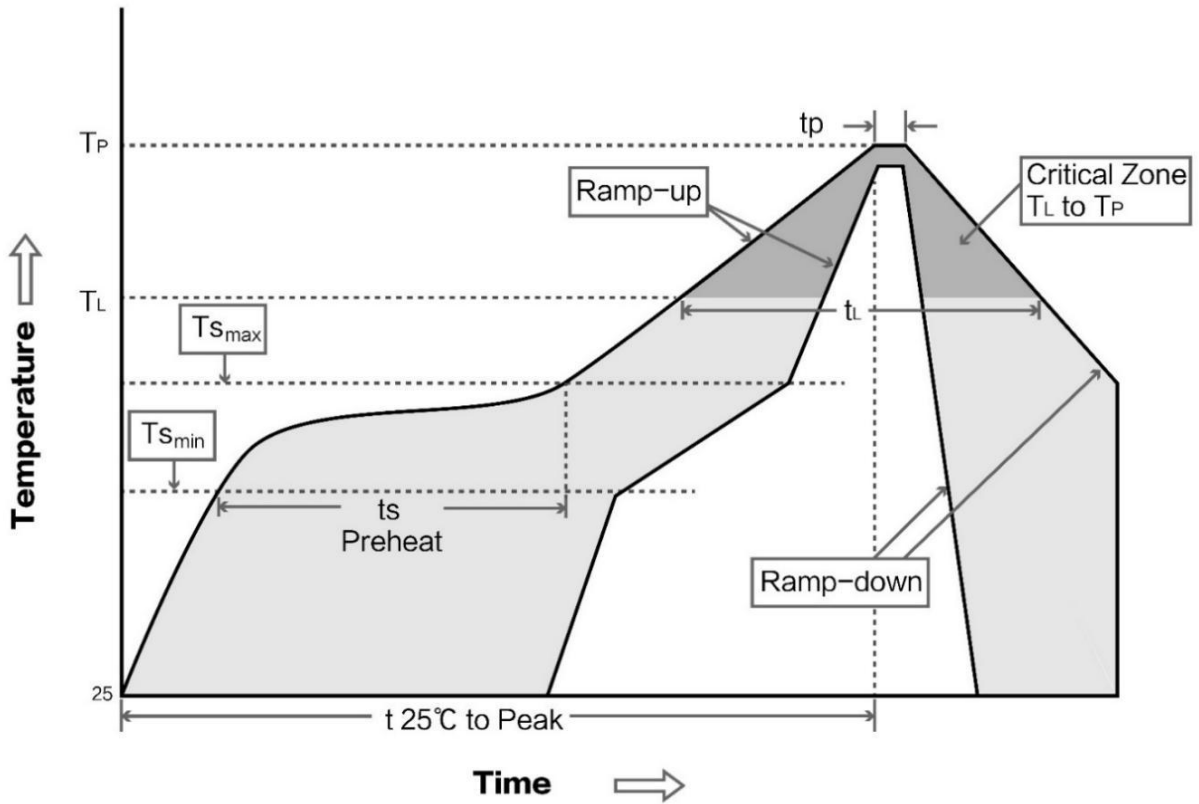

9. Packing

9.1 Anti-statistic pallet

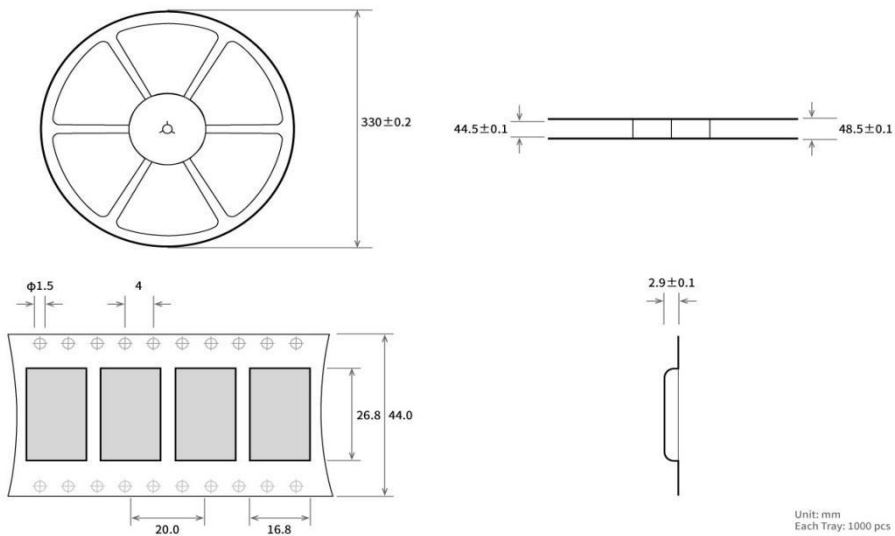

Unit: mm
Each Tray: 1000 pcs

Revision history

Version	Date	Description	Issued by
1.0	2019-3-12	Original version	Ray
1.1	2019-7-5	Revision	Blue

About us

Technical support: support@cdebyte.com

Documents and RF Setting download link: www.ebyte.com

Thank you for using Ebyte products! Please contact us with any questions or suggestions: info@cdebyte.com

Fax: 028-64146160 ext. 821

Web: www.ebyte.com

Address: Innovation Center D347, 4# XI-XIN Road, Chengdu, Sichuan, China

