



Strap-on temperature sensor

QAD2...

- Strap-on sensor for acquiring the temperature of pipework.
- Range of use -30... 125/130 °C / 5...95 % r. F. non-condensing (not suitably for chillers)

Use

Acquisition of temperature of pipework for

- controlling or limiting the flow temperature
- limiting the return temperature
- controlling the d.h.w. temperature

Type summary

<i>Type reference</i>	<i>Sensing element</i>	<i>Range of use</i>	<i>Time constant</i>
QAD22	LG-Ni 1000	-30...+130 °C	3 s
QAD2010	Pt 100	-30...+130 °C	3 s
QAD2012	Pt 1000	-30...+130 °C	3 s
QAD2030	NTC 10k	-30...+125 °C	6 s

Ordering

When ordering, please give type reference, e.g.:
Strap-on temperature sensor QAD2...

Equipment combinations

The QAD2... is suited for use with all types of controllers that can handle analog passive sensor signals.

The sensor's nickel sensing element acquires the temperature of pipework. The resistance of the sensing element changes as a function of the medium temperature. The resistance value is used for handling by a suitable controller.

Sensing element

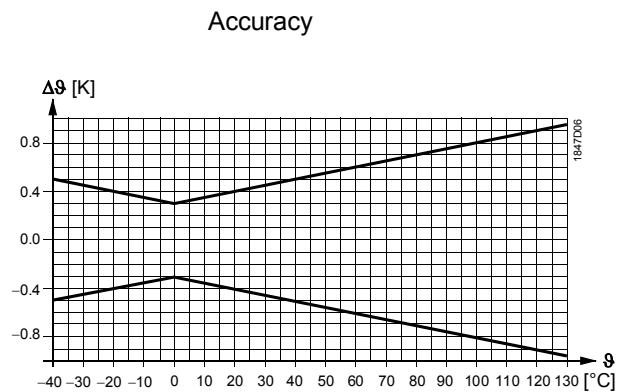
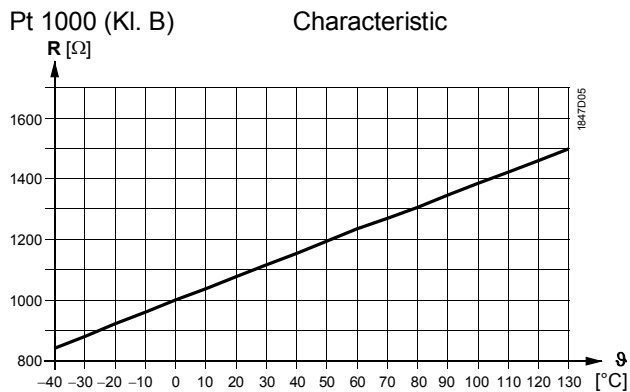
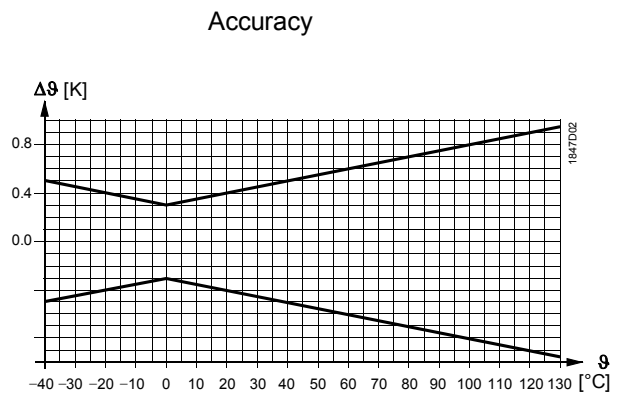
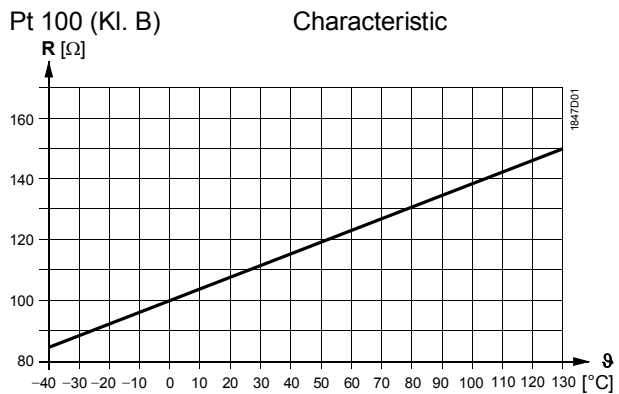
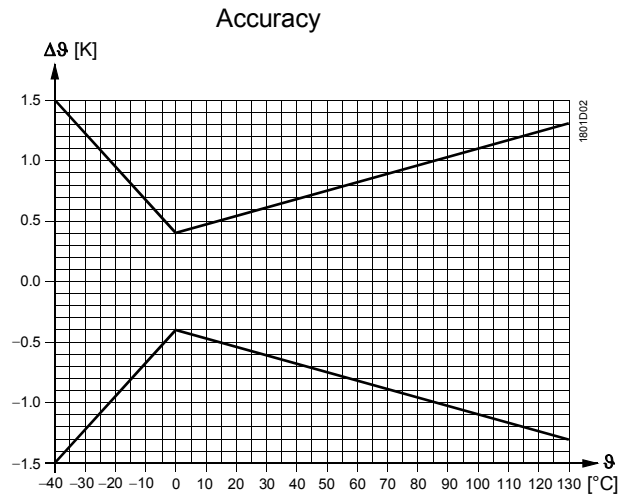
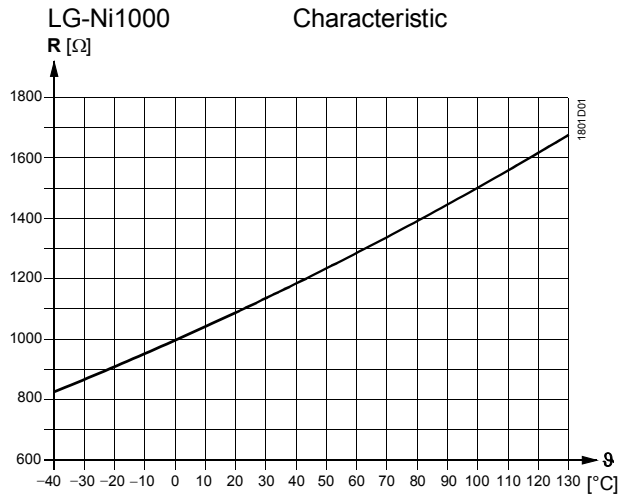

NTC 10k

Characteristic

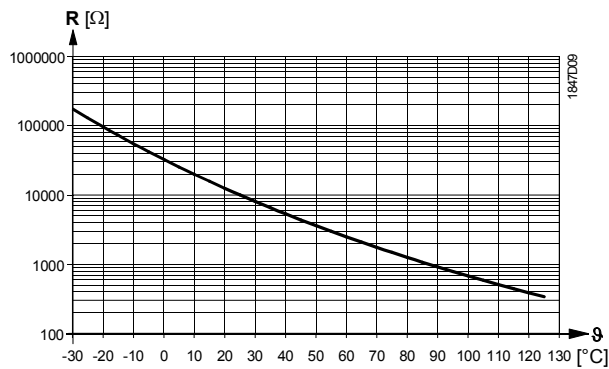

Accuracy

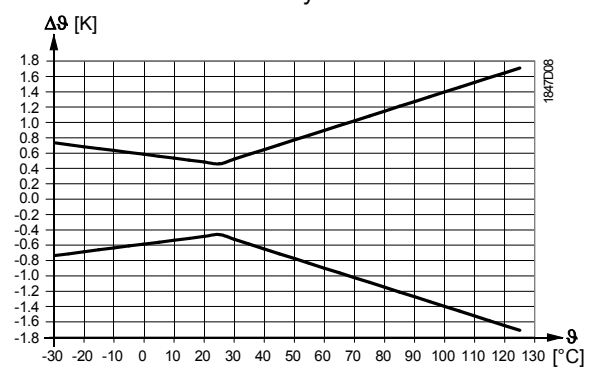

Legend

- R Resistance in Ohm
 θ Temperature in degrees Celsius
 $\Delta\theta$ Temperature differential in Kelvin

Mechanical design

The strap-on temperature sensor consists of the following components:

- Two-sectional plastic housing comprised of base with connection terminals, grommet and removable cover (snap-on design)
- The coupling sheet with sensing element is flexible and adapts to the pipe's surface
- Mounting clamp (adjustable strap-on band) for pipe diameters from 15...140 mm

The connection terminals can be accessed after removing the housing cover. Cable entry is made via a grommet (tension relief into housing). If required, the grommet can be replaced by a Pg 11 cable entry gland.

Engineering notes

The permissible cable lengths are dependent on the controller with which the sensor is used. They are specified in the Data Sheet of the relevant controller.

Mounting and installation notes

Depending on the application, the sensor is to be located as follows:

- For flow temperature control:
 - In the heating flow:
 - Directly after the pump if the pump is located in the flow
 - 1.5 to 2 m after the mixing valve if the pump is located in the return
- For limiting the return temperature:
 - In the return at a location where the temperature can be correctly acquired

The water must be well mixed where the temperature is acquired.

The pipe may not be lagged in the vicinity of the sensor.

The sensor should be mounted such that the cable does not enter from the top.

Permitted mounting positions

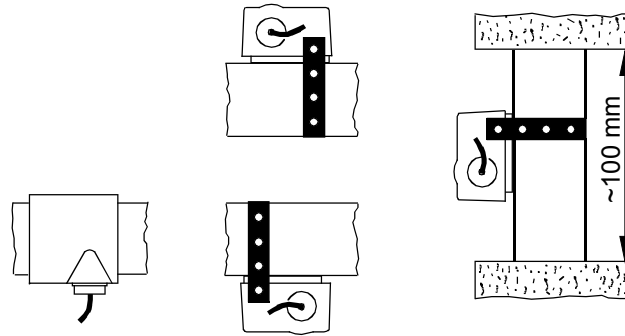

Not permitted mounting position

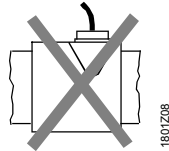

Fixing

Mounting Instructions are printed on the packaging.

- Remove any paint on the pipe before fitting the strap-on temperature sensor.
- Ensure that the sensor is fixed firmly with the adjustable band supplied.

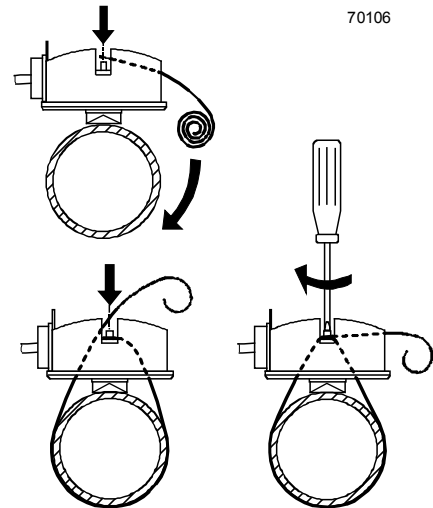

Disposal



The device is considered electrical and electronic equipment for disposal in terms of the applicable European Directive and may not be disposed of as domestic garbage.

- Dispose of the device via the channels provided for this purpose.
- Comply with all local and currently applicable laws and regulations.

Technical data

General sensor data	Range of use	refer to "Type summary"
	Sensing element	refer to "Type summary"
	Time constant t_{63}	refer to "Typ summary" (referred to the pipe's surface)
	Measurement accuracy	refer to "Function"
	Measured medium	water, other liquid media
	Type of measurement and output	passive
Degree of protection	Protection class	III according to EN 60730-1
	Protection degree of housing	IP42 according to IEC 60529
Electrical connections	Screw terminals for	max. 1 x 2.5 mm ²
	Cable entry Pg 11 cable entry gland	grommet for cable of 5.5...7.2 mm dia. can be fitted
	Permitted cable lengths	refer to Data Sheet of controller
Environmental conditions	Operation	as per IEC 60721-3-3
	Climatic conditions	class 3K5
	Temperature (housing)	-5...+50 °C
	Humidity (housing)	5...95 % r.h.
	Transport	as per IEC 60721-3-2
	Climatic conditions	class 2K3
Temperature	-25...+70 °C	
Humidity	<95 % r.h.	
Mechanical conditions	class 2M2	
Materials	Base	PA-GF35
	Housing cover	ASA Luran S
	Adjustable strap-on band	stainless steel
Directives and Standards	Product standard	EN 60730-1 Automatic electrical controls for household and similar use
	EU conformity (CE)	8000073890 *)
Environmental compatibility	The product environmental declaration CE1E1701 ¹⁾ contains data on environmentally compatible product design and assessments (RoHS compliance, materials composition, packaging, environmental benefit, disposal).	
	Packaging	Cardboard
Colors	Base	silver-grey, RAL 7001
	Housing cover	light-grey, RAL 7035
Weight	without packaging	0.072 kg
	incl. packaging	0.083 kg

*) The documents can be downloaded from <http://siemens.com/bt/download>

Internal diagram

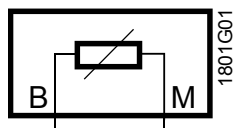

The connecting wires are interchangeable.

Dimensions (in mm)

